

# CM1631

## LCD and Camera EMI Filter Array with ESD Protection

### Product Description

The CM1631 is a family of pi-style EMI filter arrays with ESD protection, which integrates four, six, or eight filters (C-R-C) in a small form factor, UDFN 0.40 mm pitch package. The CM1631 has component values of 15 pF – 100 Ω – 15 pF per channel with a cut-off frequency of 120 MHz, and can be used in applications with data rates up to 48 Mbps. The device includes ESD diodes on every pin, that provide a very high level of protection for sensitive electronic components against possible electrostatic discharge (ESD). The ESD protection diodes safely dissipate ESD strikes of ±15 kV, which is well beyond the maximum requirement of the IEC61000-4-2 international standard. Using the MIL-STD-883 (Method 3015) specification for Human Body Model (HBM) ESD, the pins are protected for contact discharges greater than ±30 kV.

These devices are particularly well-suited for portable electronics (e.g. wireless handsets, PDAs, notebook computers) because of their small package and easy-to-use pin assignments. In particular, the CM1631 is ideal for EMI filtering and protecting data and control lines for the I/O data ports, LCD display and camera interface in mobile handsets.

The CM1631 is housed in space-saving, ultra-low-profile 8-, 12- and 16-lead UDFN packages with a 0.40 mm pitch and is available with lead-free finishing. This smaller size UDFN package provides up to 42% board space saving vs. the 0.50 mm pitch UDFN packages.

### Features

- Four, Six and Eight Channels of EMI Filtering with Integrated ESD Protection
- Pi-Style EMI Filters in a Capacitor-Resistor-Capacitor (C-R-C) Network
- ±15 kV ESD Protection on Each Channel (IEC 61000-4-2 Level 4, Contact Discharge)
- ±30 kV ESD Protection on Each Channel (HBM)
- Greater than 35 dB Attenuation (Typical) at 1 GHz
- UDFN Package with 0.40 mm Lead Pitch:
  - ◆ 4-ch. = 8-lead UDFN
  - ◆ 6-ch. = 12-lead UDFN
  - ◆ 8-ch. = 16-lead UDFN
- Tiny UDFN Package Size:
  - ◆ 8-lead: 1.70 mm x 1.35 x 0.50 mm
  - ◆ 12-lead: 2.50 mm x 1.35 x 0.50 mm
  - ◆ 16-lead: 3.30 mm x 1.35 x 0.50 mm
- Increased Robustness against Vertical Impacts During Manufacturing Process
- These Devices are Pb-Free and are RoHS Compliant

### Applications

- LCD and Camera Data Lines in Mobile Handsets
- EMI Filtering for Data Ports in Cell Phones, PDAs or Notebook Computers
- LCD and Camera Modules
- I/O Port Protection for Mobile Handsets, Notebook Computers, PDAs, etc.
- Handheld PCs/PDAs
- Wireless Handsets



ON Semiconductor®

<http://onsemi.com>



UDFN8  
DE SUFFIX  
CASE 517BC



UDFN12  
DE SUFFIX  
CASE 517BD



UDFN16  
DE SUFFIX  
CASE 517BE

### ELECTRICAL SCHEMATIC

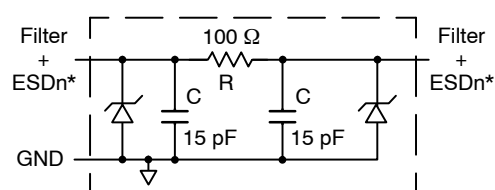

1 of 4, 6 or 8 EMI/RFI + ESD Channels

\* See Package/Pinout Diagrams for expanded pin information.

### MARKING DIAGRAM

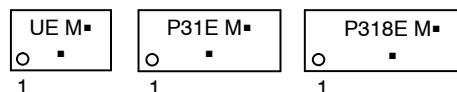

UE = CM1631-04DE  
 P31E = CM1631-06DE  
 P318E = CM1631-08DE  
 M = Date Code  
 ■ = Pb-Free Package

(Note: Microdot may be in either location)

### ORDERING INFORMATION

Device	Package	Shipping†
CM1631-04DE	UDFN-8 (Pb-Free)	3000/Tape & Reel
CM1631-06DE	UDFN-12 (Pb-Free)	3000/Tape & Reel
CM1631-08DE	UDFN-16 (Pb-Free)	3000/Tape & Reel

†For information on tape and reel specifications, including part orientation and tape sizes, please refer to our Tape and Reel Packaging Specification Brochure, BRD8011/D.

# CM1631

## PACKAGE / PINOUT DIAGRAMS

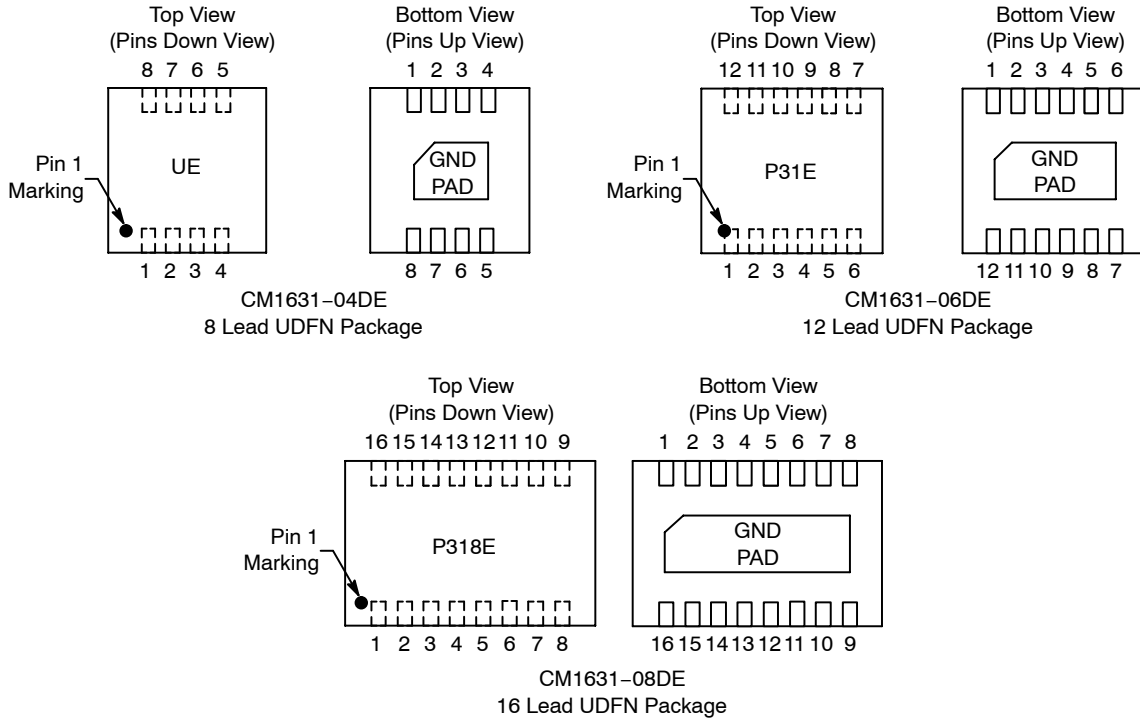

**Table 1. PIN DESCRIPTIONS**

Device Pin(s)			Name	Description	Device Pin(s)			Name	Description
-04	-06	-08			-04	-06	-08		
1	1	1	FILTER1	Filter + ESD Channel 1	8	12	16	FILTER1	Filter + ESD Channel 1
2	2	2	FILTER2	Filter + ESD Channel 2	7	11	15	FILTER2	Filter + ESD Channel 2
3	3	3	FILTER3	Filter + ESD Channel 3	6	10	14	FILTER3	Filter + ESD Channel 3
4	4	4	FILTER4	Filter + ESD Channel 4	5	9	13	FILTER4	Filter + ESD Channel 4
-	5	5	FILTER5	Filter + ESD Channel 5	-	8	12	FILTER5	Filter + ESD Channel 5
-	6	6	FILTER6	Filter + ESD Channel 6	-	7	11	FILTER6	Filter + ESD Channel 6
-	-	7	FILTER7	Filter + ESD Channel 7	-	-	10	FILTER7	Filter + ESD Channel 7
-	-	8	FILTER8	Filter + ESD Channel 8	-	-	9	FILTER8	Filter + ESD Channel 8
GND PAD			GND	Device Ground	-	-	-	-	

# CM1631

## SPECIFICATIONS

**Table 2. ABSOLUTE MAXIMUM RATINGS**

Parameter	Rating	Units
Storage Temperature Range	-65 to +150	°C
DC Power per Resistor	100	mW
DC Package Power Rating	500	mW

Stresses exceeding Maximum Ratings may damage the device. Maximum Ratings are stress ratings only. Functional operation above the Recommended Operating Conditions is not implied. Extended exposure to stresses above the Recommended Operating Conditions may affect device reliability.

**Table 3. STANDARD OPERATING CONDITIONS**

Parameter	Rating	Units
Operating Temperature Range	-40 to +85	°C

**Table 4. ELECTRICAL OPERATING CHARACTERISTICS** (Note 1)

Symbol	Parameter	Conditions	Min	Typ	Max	Units
R	Resistance		80	100	120	Ω
C <sub>TOTAL</sub>	Total Channel Capacitance	At 2.5 V DC Reverse Bias, 1 MHz, 30 mV AC	24	30	36	pF
C	Capacitance C	At 2.5 V DC Reverse Bias, 1 MHz, 30 mV AC	12	15	18	pF
V <sub>DIODE</sub>	Stand-off Voltage	I <sub>DIODE</sub> = 10 μA		6.0		V
I <sub>LEAK</sub>	Diode Leakage Current (Reverse Bias)	V <sub>DIODE</sub> = 3.3 V		0.1	1.0	μA
V <sub>SIG</sub>	Signal Clamp Voltage Positive Clamp Negative Clamp	I <sub>LOAD</sub> = 10 mA I <sub>LOAD</sub> = -10 mA	5.6 -0.4	6.8 -0.8		V
V <sub>ESD</sub>	In-system ESD Withstand Voltage a) Human Body Model, MIL-STD-883, Method 3015 b) Contact Discharge per IEC 61000-4-2 Level 4	(Note 2)	±30 ±15			kV
R <sub>DYN</sub>	Dynamic Resistance Positive Negative			2.3 0.9		Ω
f <sub>C</sub>	Cut-off Frequency Z <sub>SOURCE</sub> = 50 Ω, Z <sub>LOAD</sub> = 50 Ω	Channel R = 100 Ω, Channel C = 15 pF		110		MHz
A <sub>1GHz</sub>	Absolute Attenuation @ 1 GHz from 0 dB Level	Z <sub>SOURCE</sub> = 50 Ω, Z <sub>LOAD</sub> = 50 Ω, DC Bias = 0 V (Notes 1 and 3)		35		dB
A <sub>800MHz - 6GHz</sub>	Absolute Attenuation @ 800 MHz to 6 GHz from 0 dB Level	Z <sub>SOURCE</sub> = 50 Ω, Z <sub>LOAD</sub> = 50 Ω, DC Bias = 0 V (Notes 1 and 3)		30		dB

1. T<sub>A</sub> = 25°C unless otherwise specified.

2. ESD applied to input and output pins with respect to GND, one at a time.

3. Attenuation / RF curves characterized by a network analyzer using microprobes.

# CM1631

## PERFORMANCE INFORMATION

Typical Filter Performance ( $T_A = 25^\circ\text{C}$ , DC Bias = 0 V, 50  $\Omega$  Environment)

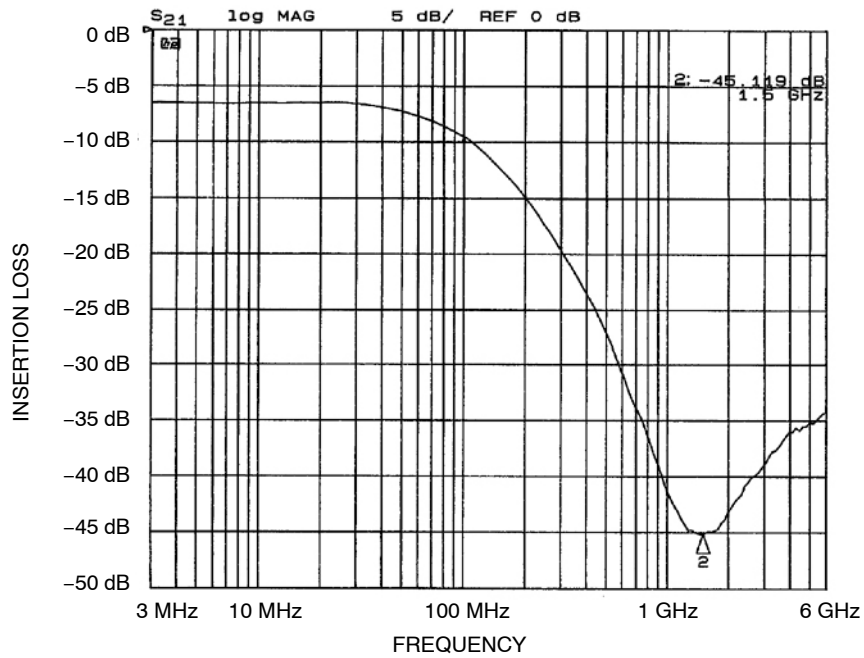

Figure 1. Insertion Loss vs. Frequency (FILTER1 Input to GND, CM1631-04DE)

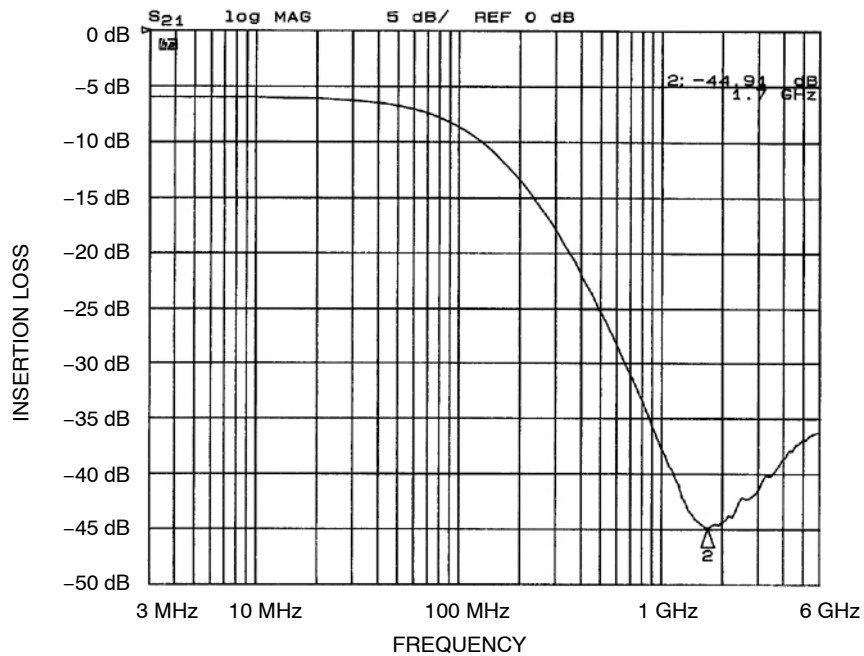

Figure 2. Insertion Loss vs. Frequency (FILTER2 Input to GND, CM1631-04DE)

# CM1631

## PERFORMANCE INFORMATION (Cont'd)

Typical Filter Performance ( $T_A = 25^\circ\text{C}$ , DC Bias = 0 V, 50  $\Omega$  Environment)

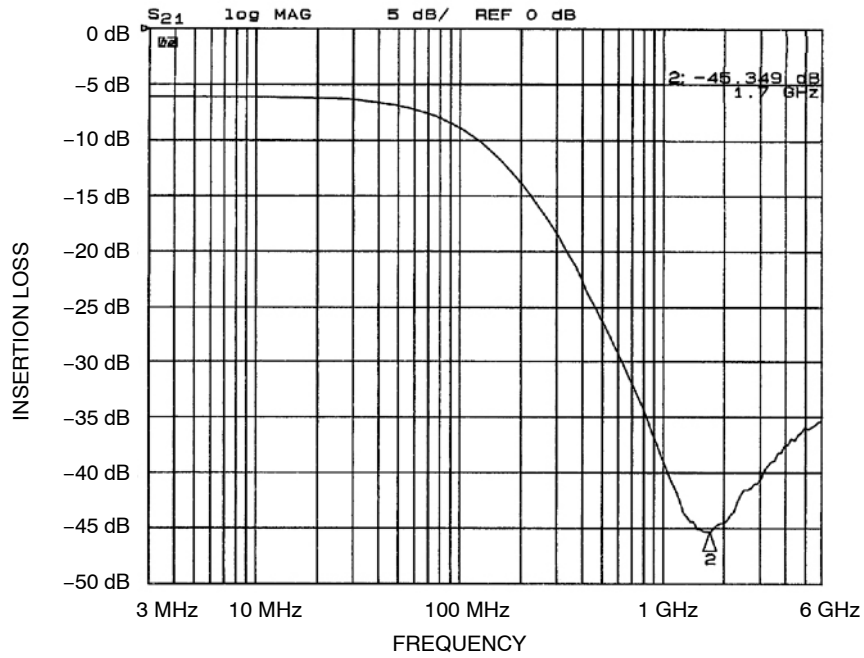

Figure 3. Insertion Loss vs. Frequency (FILTER3 Input to GND, CM1631-04DE)

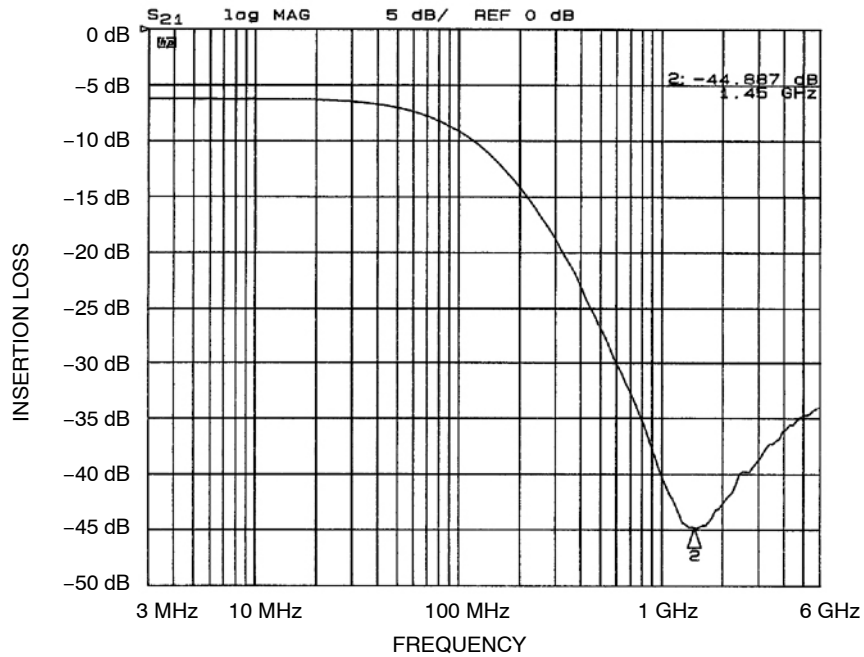

Figure 4. Insertion Loss vs. Frequency (FILTER4 Input to GND, CM1631-04DE)

# CM1631

## PERFORMANCE INFORMATION (Cont'd)

Typical Filter Performance ( $T_A = 25^\circ\text{C}$ , DC Bias = 0 V, 50  $\Omega$  Environment)

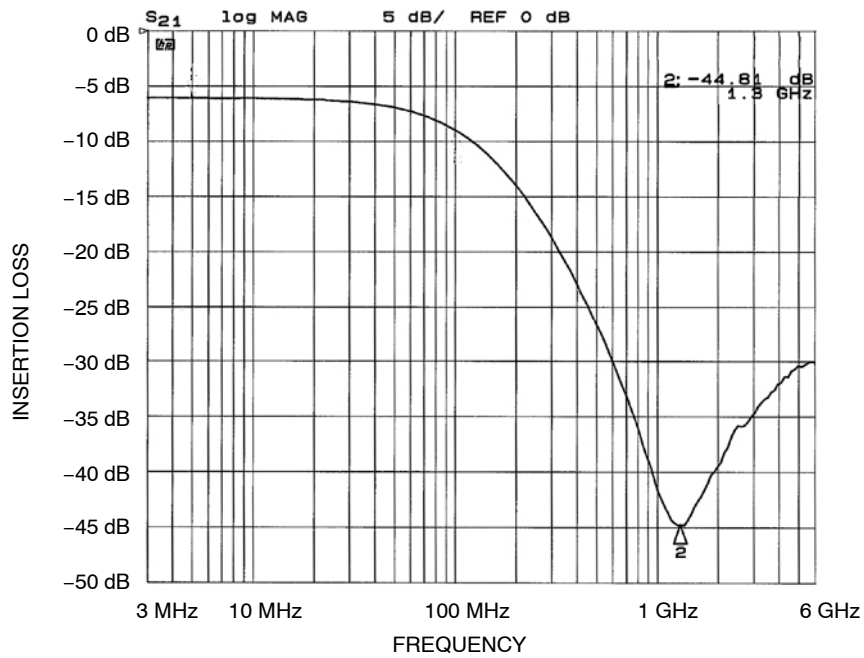

Figure 5. Insertion Loss vs. Frequency (FILTER1 Input to GND, CM1631-06DE)

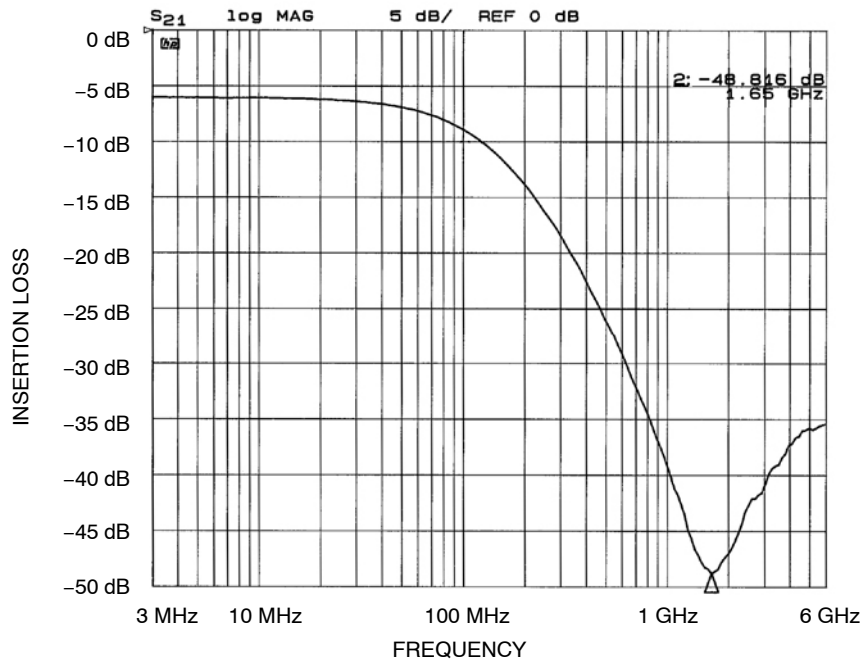

Figure 6. Insertion Loss vs. Frequency (FILTER2 Input to GND, CM1631-06DE)

# CM1631

## PERFORMANCE INFORMATION (Cont'd)

Typical Filter Performance ( $T_A = 25^\circ\text{C}$ , DC Bias = 0 V, 50  $\Omega$  Environment)

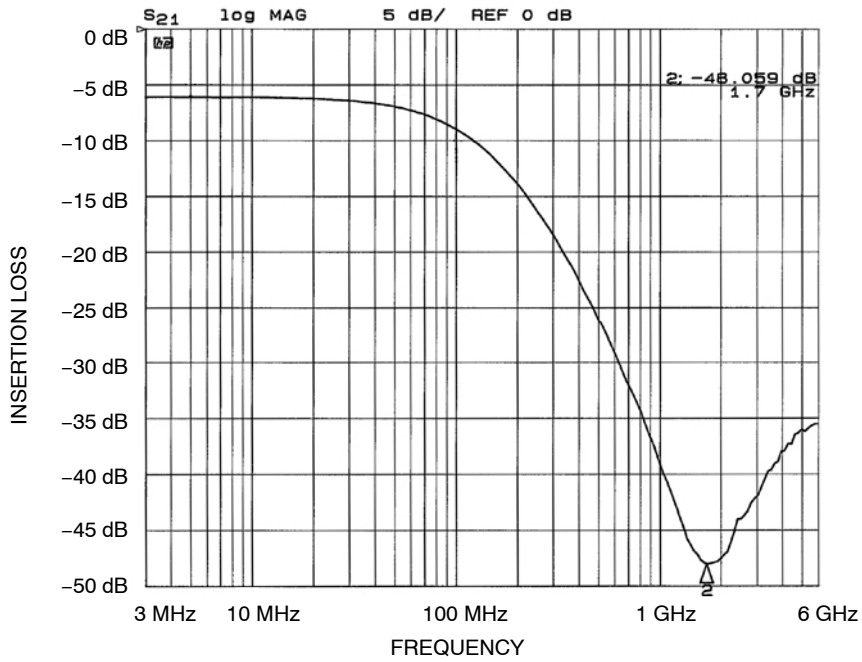

Figure 7. Insertion Loss vs. Frequency (FILTER3 Input to GND, CM1631-06DE)

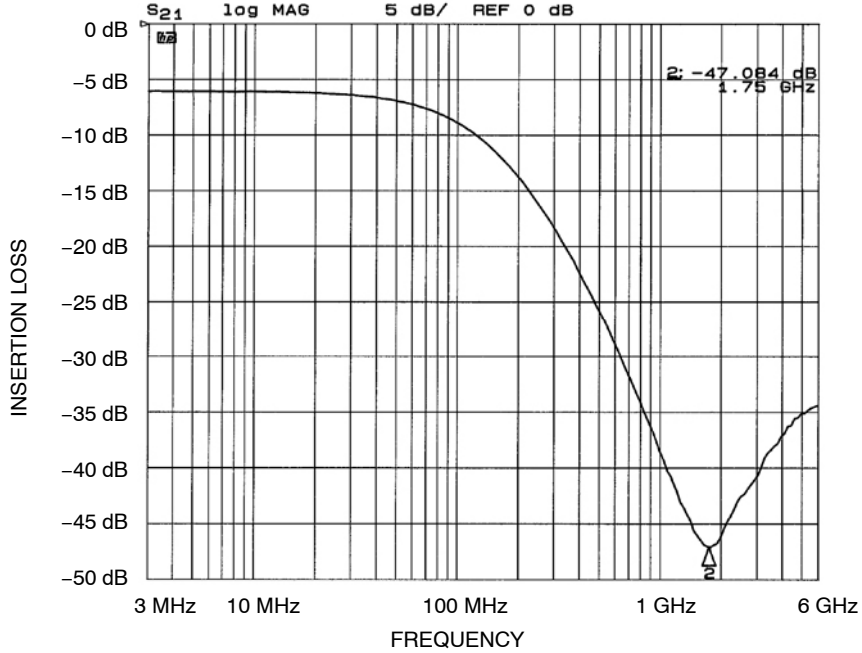

Figure 8. Insertion Loss vs. Frequency (FILTER4 Input to GND, CM1631-06DE)

# CM1631

## PERFORMANCE INFORMATION (Cont'd)

Typical Filter Performance ( $T_A = 25^\circ\text{C}$ , DC Bias = 0 V, 50  $\Omega$  Environment)

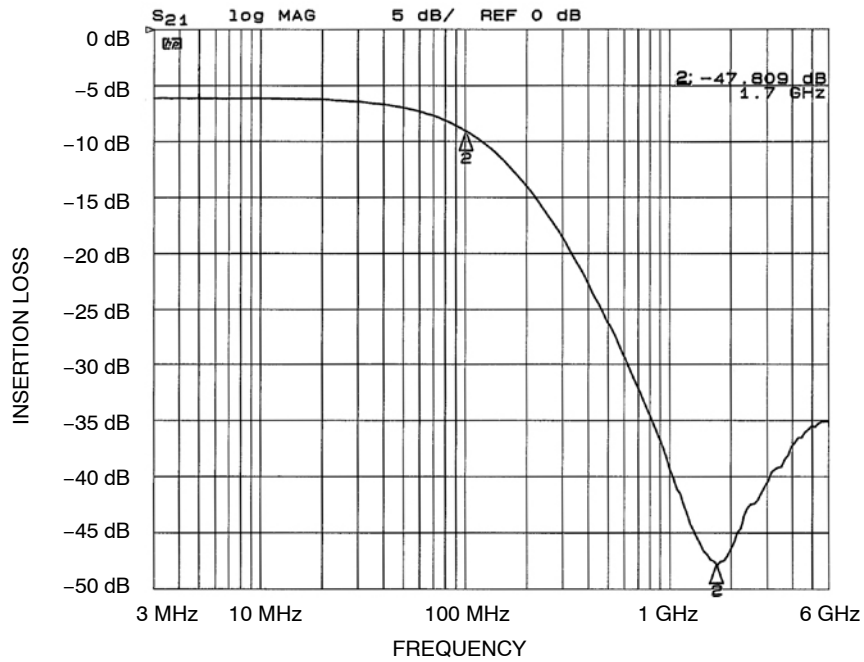

Figure 9. Insertion Loss vs. Frequency (FILTER5 Input to GND, CM1631-06DE)

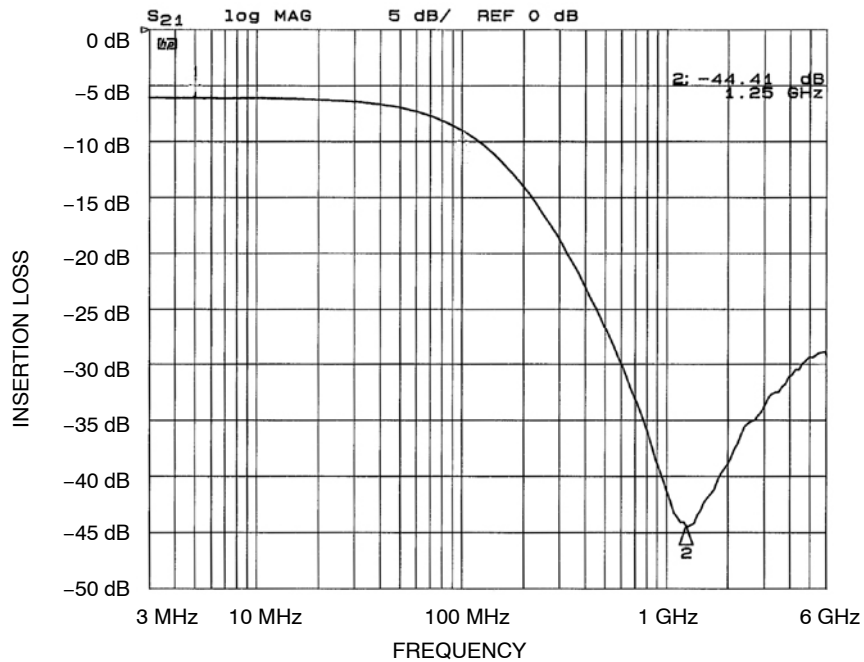

Figure 10. Insertion Loss vs. Frequency (FILTER6 Input to GND, CM1631-06DE)



# CM1631

## PERFORMANCE INFORMATION (Cont'd)

Typical Filter Performance ( $T_A = 25^\circ\text{C}$ , DC Bias = 0 V, 50  $\Omega$  Environment)

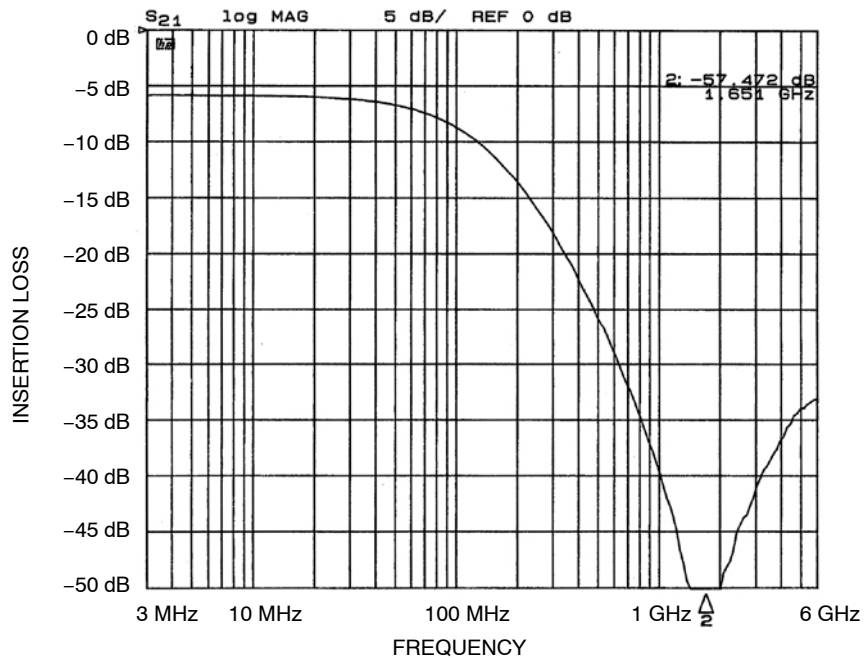

Figure 11. Insertion Loss vs. Frequency (FILTER1 Input to GND, CM1631-08DE)

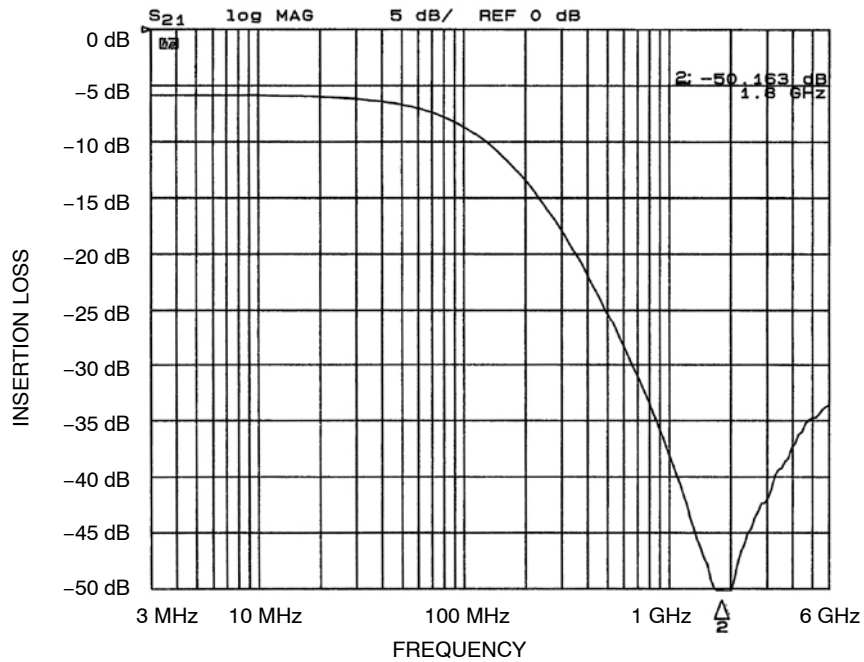

Figure 12. Insertion Loss vs. Frequency (FILTER2 Input to GND, CM1631-08DE)

# CM1631

## PERFORMANCE INFORMATION (Cont'd)

Typical Filter Performance ( $T_A = 25^\circ\text{C}$ , DC Bias = 0 V, 50  $\Omega$  Environment)

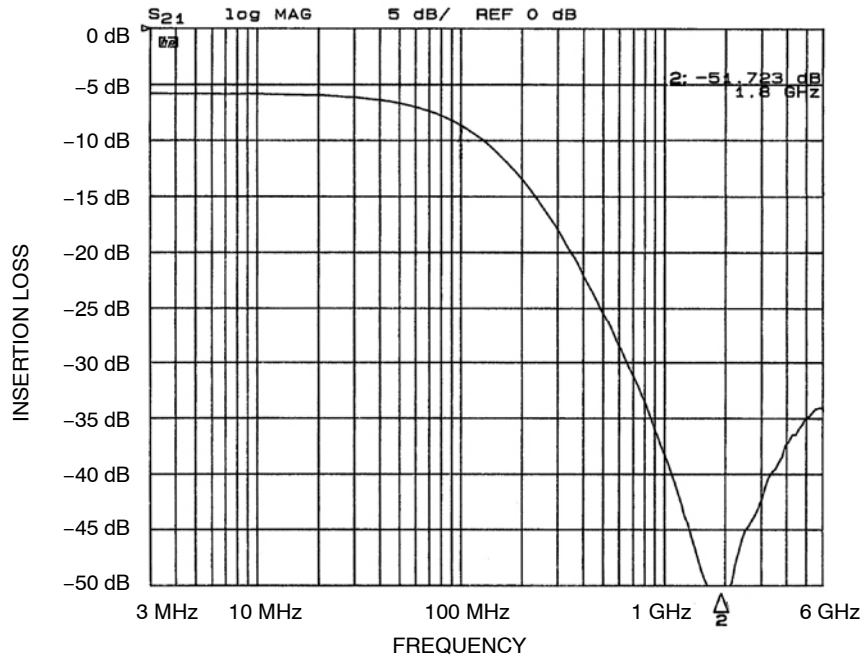

Figure 13. Insertion Loss vs. Frequency (FILTER3 Input to GND, CM1631-08DE)

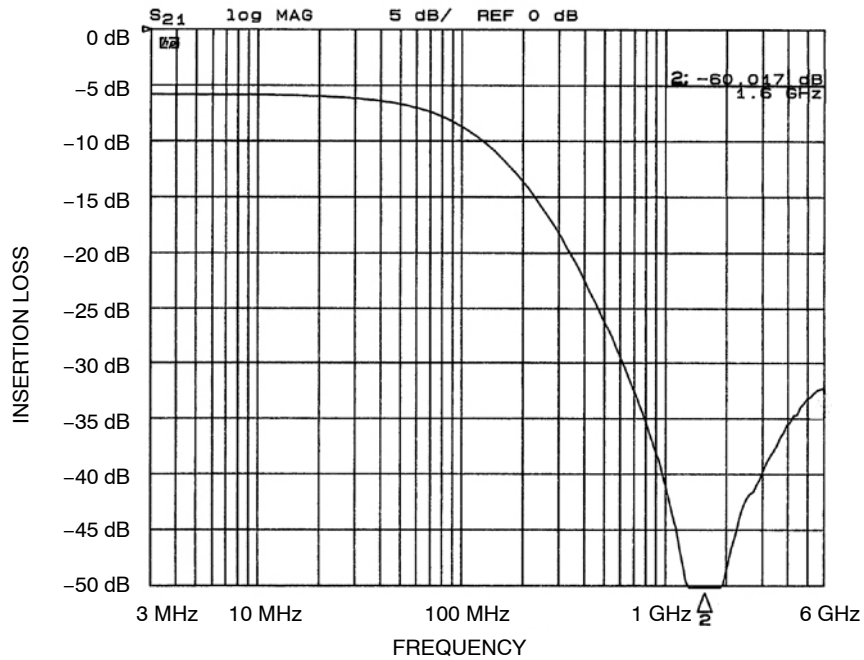

Figure 14. Insertion Loss vs. Frequency (FILTER4 Input to GND, CM1631-08DE)

# CM1631

## PERFORMANCE INFORMATION (Cont'd)

Typical Filter Performance ( $T_A = 25^\circ\text{C}$ , DC Bias = 0 V, 50  $\Omega$  Environment)

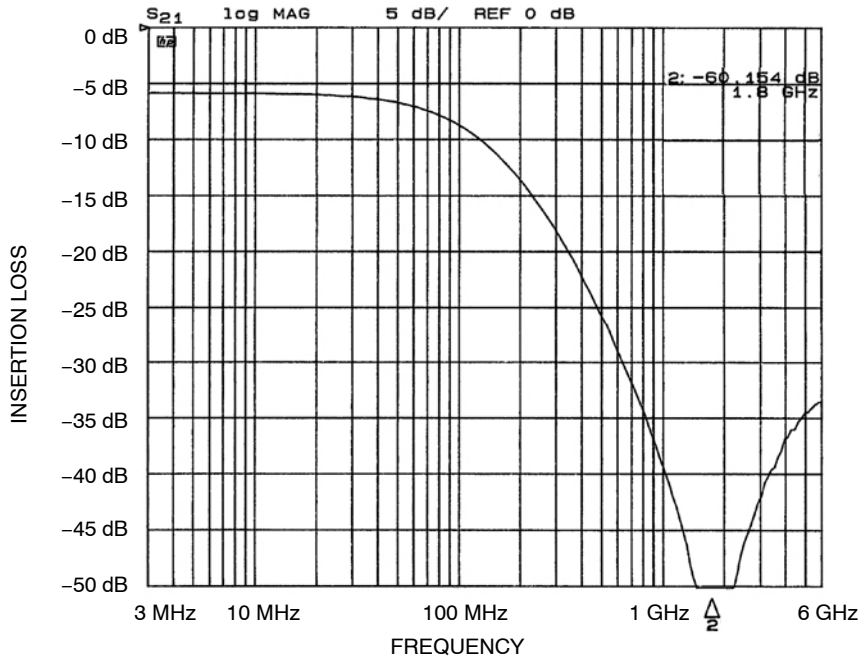

Figure 15. Insertion Loss vs. Frequency (FILTER5 Input to GND, CM1631-08DE)

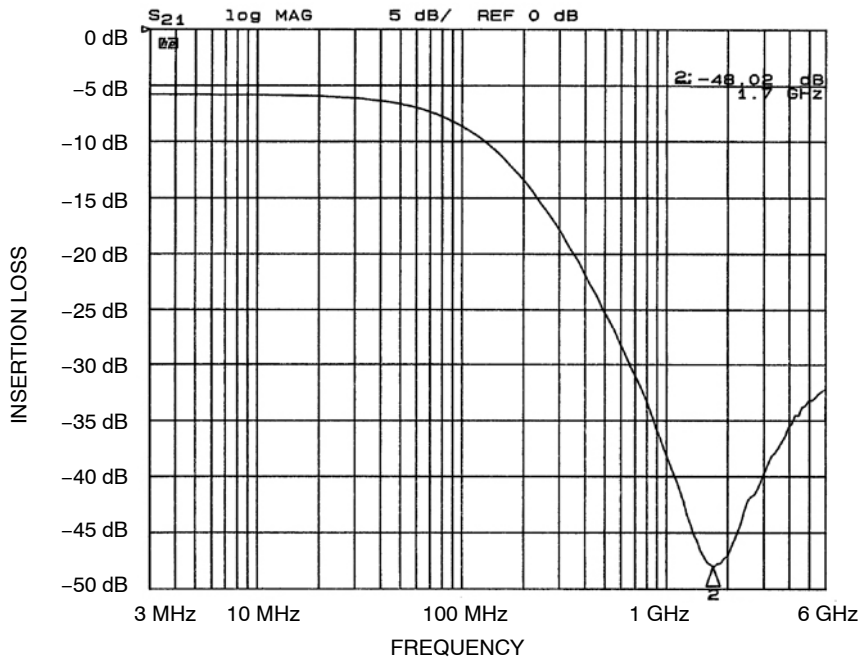

Figure 16. Insertion Loss vs. Frequency (FILTER6 Input to GND, CM1631-08DE)

# CM1631

## PERFORMANCE INFORMATION (Cont'd)

Typical Filter Performance ( $T_A = 25^\circ\text{C}$ , DC Bias = 0 V, 50  $\Omega$  Environment)

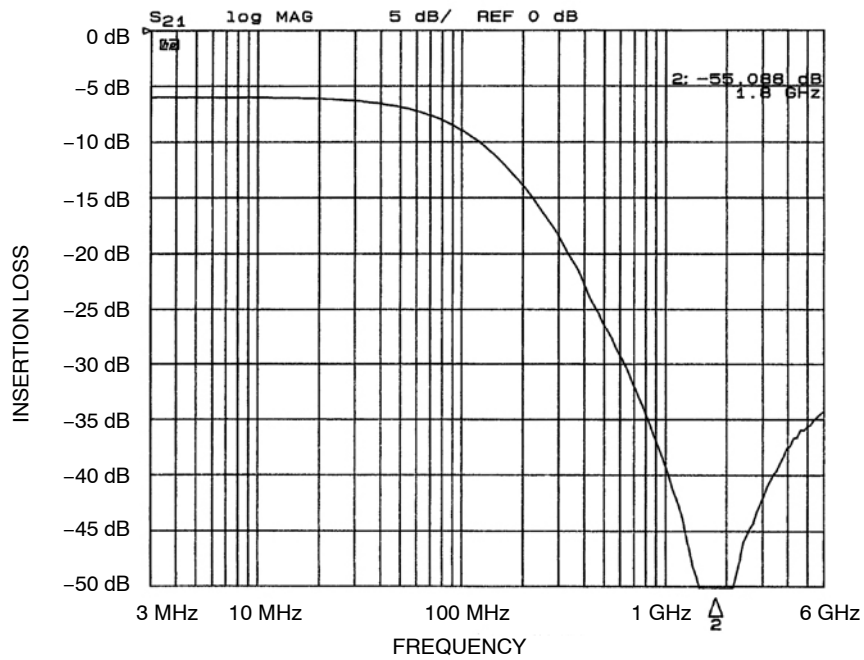

Figure 17. Insertion Loss vs. Frequency (FILTER7 Input to GND, CM1631-08DE)

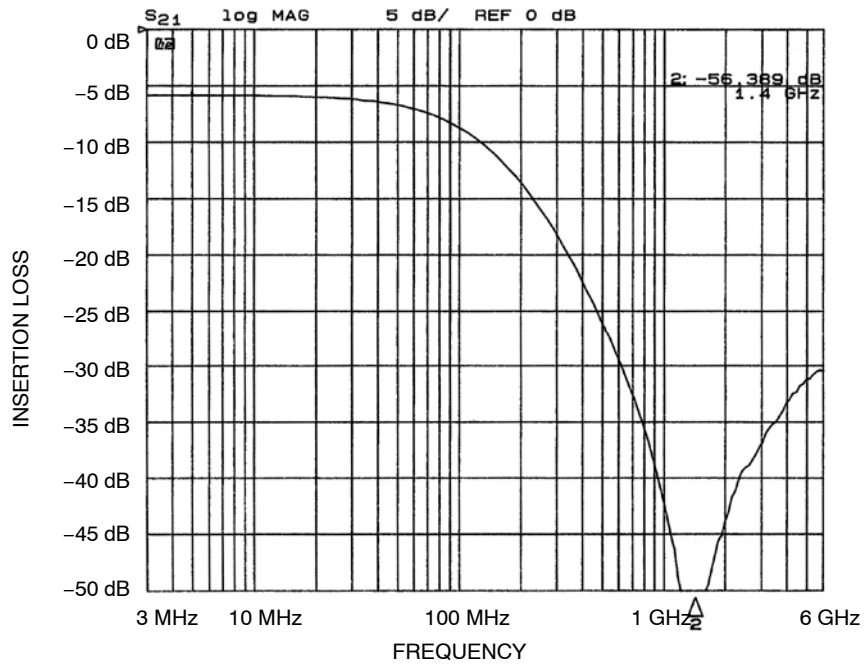
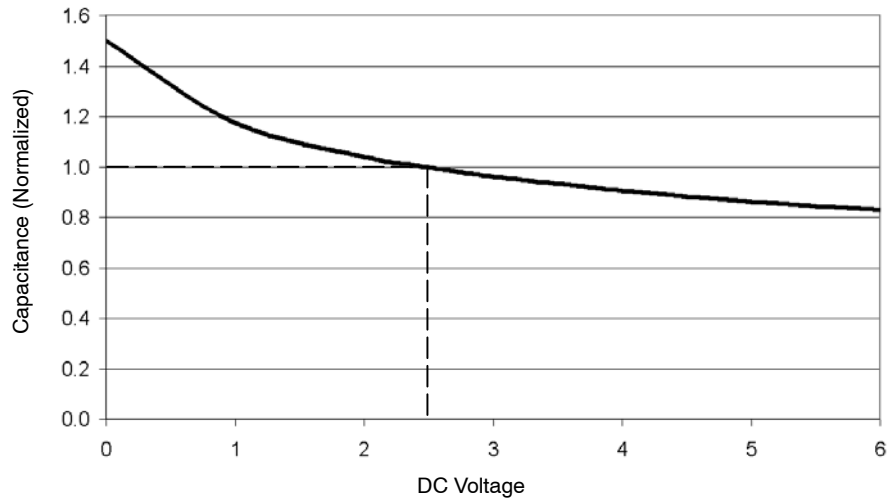

Figure 18. Insertion Loss vs. Frequency (FILTER8 Input to GND, CM1631-08DE)

PERFORMANCE INFORMATION (Cont'd)

Typical Diode Capacitance vs. Input Voltage



**Figure 19. Filter Capacitance vs. Input Voltage  
(normalized to capacitance at 2.5 V DC and 25°C)**

# MECHANICAL CASE OUTLINE PACKAGE DIMENSIONS



SCALE 4:1

**UDFN8, 1.7x1.35, 0.4P**  
CASE 517BC  
ISSUE A

DATE 11 AUG 2022

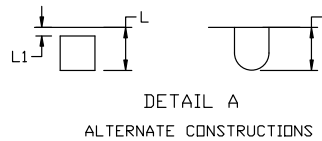
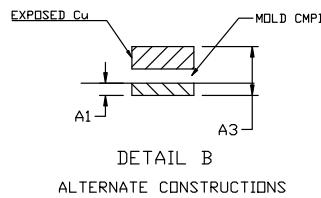
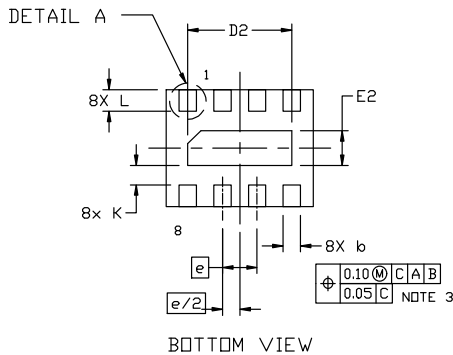
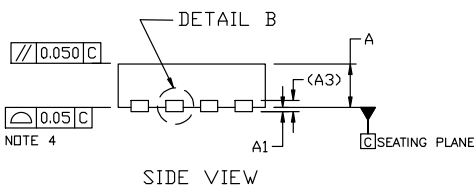
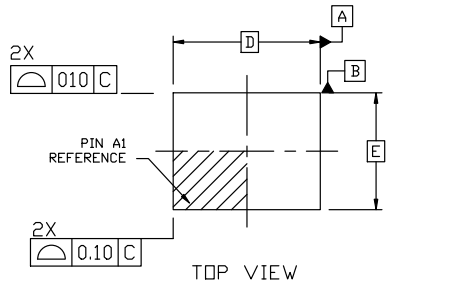

NOTES:

1. DIMENSIONING AND TOLERANCING PER ASME Y14.5M, 2004.
2. CONTROLLING DIMENSION: MILLIMETERS.
3. DIMENSION b APPLIES TO PLATED TERMINAL AND IS MEASURED BETWEEN 0.15 AND 0.25MM FROM THE TERMINAL TIP.
4. COPLANARITY APPLIES TO THE EXPOSED PADS AS WELL AS THE TERMINALS.

DIM	MILLIMETERS	
	MIN.	MAX.
A	0.45	0.55
A1	0.00	0.05
A3	0.13 REF	
b	0.15	0.25
D	1.70 BSC	
D2	1.10	1.30
E	1.35 BSC	
E2	0.30	0.50
e	0.40 BSC	
K	0.15	---
L	0.20	0.30
L1	---	0.05

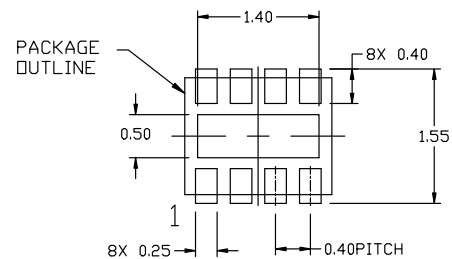

**GENERIC MARKING DIAGRAMS\***



XXX = Specific Device Code  
M = Date Code  
▪ = Pb-Free Package

(Note: Microdot may be in either location)

\*This information is generic. Please refer to device data sheet for actual part marking. Pb-Free indicator, "G" or microdot "▪", may or may not be present. Some products may not follow the Generic Marking.

\* For additional information on our Pb-Free strategy and soldering details, please download the [EN Semiconductor Soldering and Mounting Techniques Reference Manual, SOLDERM/D](#).

<b>DOCUMENT NUMBER:</b>	<b>98AON47060E</b>	Electronic versions are uncontrolled except when accessed directly from the Document Repository. Printed versions are uncontrolled except when stamped "CONTROLLED COPY" in red.
<b>DESCRIPTION:</b>	<b>UDFN8, 1.7x1.35, 0.4P</b>	<b>PAGE 1 OF 1</b>

onsemi and onsemi are trademarks of Semiconductor Components Industries, LLC dba onsemi or its subsidiaries in the United States and/or other countries. onsemi reserves the right to make changes without further notice to any products herein. onsemi makes no warranty, representation or guarantee regarding the suitability of its products for any particular purpose, nor does onsemi assume any liability arising out of the application or use of any product or circuit, and specifically disclaims any and all liability, including without limitation special, consequential or incidental damages. onsemi does not convey any license under its patent rights nor the rights of others.

# MECHANICAL CASE OUTLINE

## PACKAGE DIMENSIONS

ON Semiconductor®

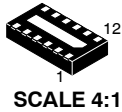

### UDFN12, 2.5x1.35, 0.4P

CASE 517BD-01  
ISSUE O

DATE 18 NOV 2009

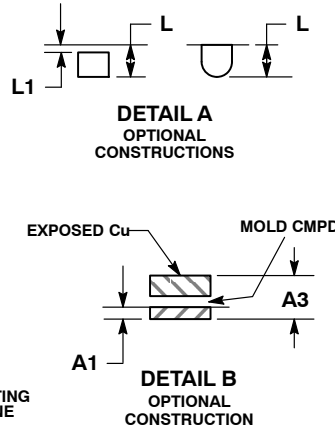
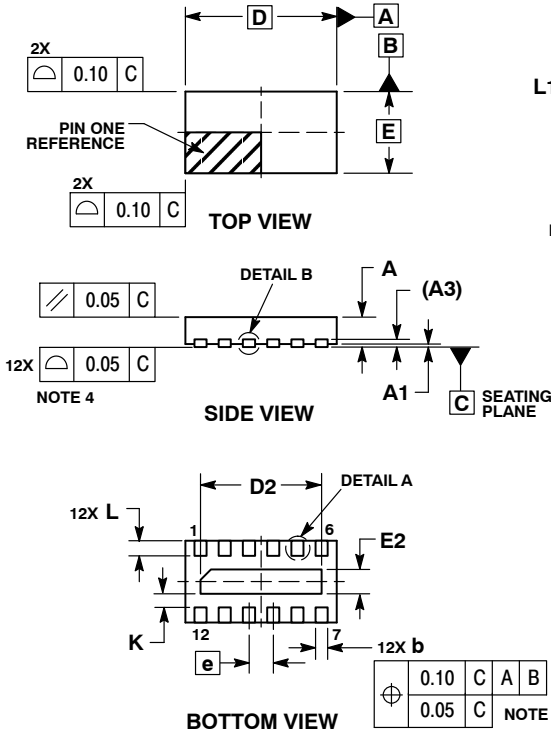

- NOTES:
- DIMENSIONING AND TOLERANCING PER ASME Y14.5M, 1994.
  - CONTROLLING DIMENSION: MILLIMETERS.
  - DIMENSION b APPLIES TO PLATED TERMINAL AND IS MEASURED BETWEEN 0.15 AND 0.25 mm FROM THE TERMINAL TIP.
  - COPLANARITY APPLIES TO THE EXPOSED PAD AS WELL AS THE TERMINALS.

MILLIMETERS		
DIM	MIN	MAX
A	0.45	0.55
A1	0.00	0.05
A3	0.13	REF
b	0.15	0.25
D	2.50	BSC
D2	1.90	2.10
E	1.35	BSC
E2	0.30	0.50
e	0.40	BSC
K	0.15	---
L	0.20	0.30
L1	---	0.05

### GENERIC MARKING DIAGRAM\*

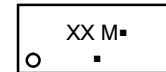

1

- XX = Specific Device Code  
M = Month Code  
▪ = Pb-Free Package

(Note: Microdot may be in either location)

\*This information is generic. Please refer to device data sheet for actual part marking.

Pb-Free indicator, "G" or microdot "▪", may or may not be present.

### RECOMMENDED SOLDERING FOOTPRINT\*

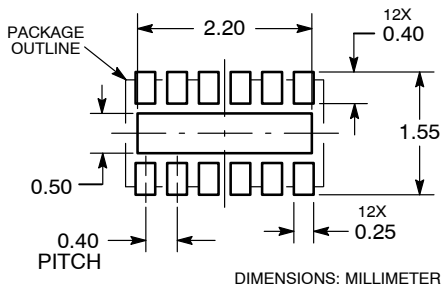

\*For additional information on our Pb-Free strategy and soldering details, please download the ON Semiconductor Soldering and Mounting Techniques Reference Manual, SOLDERRM/D.

<b>DOCUMENT NUMBER:</b>	<b>98AON47061E</b>	Electronic versions are uncontrolled except when accessed directly from the Document Repository. Printed versions are uncontrolled except when stamped "CONTROLLED COPY" in red.
<b>DESCRIPTION:</b>	<b>UDFN12, 2.5X1.35, 0.4P</b>	<b>PAGE 1 OF 1</b>

ON Semiconductor and ON are trademarks of Semiconductor Components Industries, LLC dba ON Semiconductor or its subsidiaries in the United States and/or other countries. ON Semiconductor reserves the right to make changes without further notice to any products herein. ON Semiconductor makes no warranty, representation or guarantee regarding the suitability of its products for any particular purpose, nor does ON Semiconductor assume any liability arising out of the application or use of any product or circuit, and specifically disclaims any and all liability, including without limitation special, consequential or incidental damages. ON Semiconductor does not convey any license under its patent rights nor the rights of others.

# MECHANICAL CASE OUTLINE

## PACKAGE DIMENSIONS

ON Semiconductor®

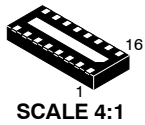

UDFN16, 3.3x1.35, 0.4P  
CASE 517BE-01  
ISSUE O

DATE 18 NOV 2009

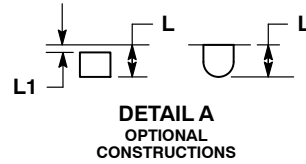
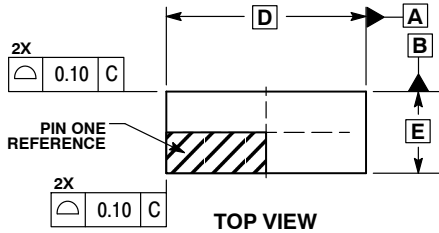

- NOTES:
1. DIMENSIONING AND TOLERANCING PER ASME Y14.5M, 1994.
  2. CONTROLLING DIMENSION: MILLIMETERS.
  3. DIMENSION b APPLIES TO PLATED TERMINAL AND IS MEASURED BETWEEN 0.15 AND 0.25 mm FROM THE TERMINAL TIP.
  4. COPLANARITY APPLIES TO THE EXPOSED PAD AS WELL AS THE TERMINALS.

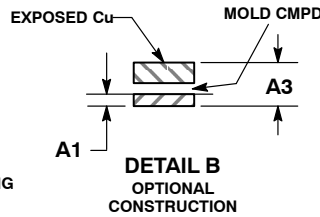
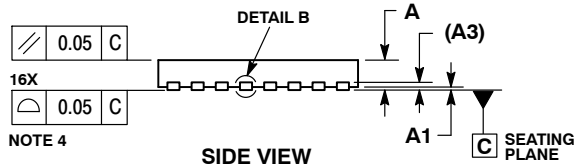

MILLIMETERS		
DIM	MIN	MAX
A	0.45	0.55
A1	0.00	0.05
A3	0.13	REF
b	0.15	0.25
D	3.30	BSC
D2	2.70	2.90
E	1.35	BSC
E2	0.30	0.50
e	0.40	BSC
K	0.15	---
L	0.20	0.30
L1	---	0.05

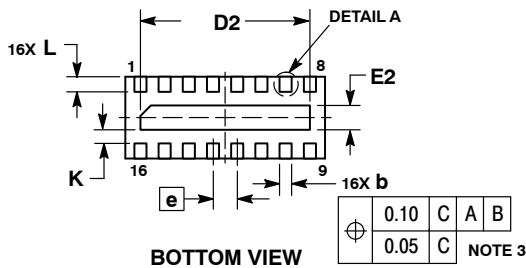

### GENERIC MARKING DIAGRAM\*

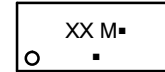

1

- XX = Specific Device Code  
M = Month Code  
▪ = Pb-Free Package

(Note: Microdot may be in either location)

\*This information is generic. Please refer to device data sheet for actual part marking.

Pb-Free indicator, "G" or microdot "▪", may or may not be present.

### RECOMMENDED SOLDERING FOOTPRINT\*

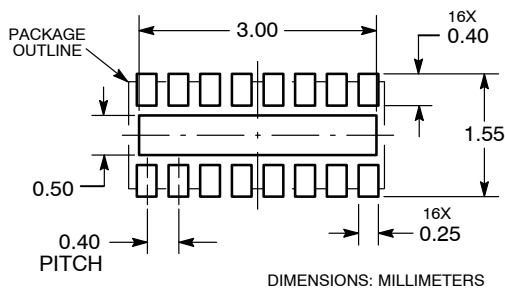

\*For additional information on our Pb-Free strategy and soldering details, please download the ON Semiconductor Soldering and Mounting Techniques Reference Manual, SOLDERRM/D.

<b>DOCUMENT NUMBER:</b>	<b>98AON47062E</b>	Electronic versions are uncontrolled except when accessed directly from the Document Repository. Printed versions are uncontrolled except when stamped "CONTROLLED COPY" in red.
<b>DESCRIPTION:</b>	<b>UDFN16, 3.3X1.35, 0.4P</b>	<b>PAGE 1 OF 1</b>

ON Semiconductor and are trademarks of Semiconductor Components Industries, LLC dba ON Semiconductor or its subsidiaries in the United States and/or other countries. ON Semiconductor reserves the right to make changes without further notice to any products herein. ON Semiconductor makes no warranty, representation or guarantee regarding the suitability of its products for any particular purpose, nor does ON Semiconductor assume any liability arising out of the application or use of any product or circuit, and specifically disclaims any and all liability, including without limitation special, consequential or incidental damages. ON Semiconductor does not convey any license under its patent rights nor the rights of others.



**onsemi**, **Onsemi**, and other names, marks, and brands are registered and/or common law trademarks of Semiconductor Components Industries, LLC dba "**onsemi**" or its affiliates and/or subsidiaries in the United States and/or other countries. **onsemi** owns the rights to a number of patents, trademarks, copyrights, trade secrets, and other intellectual property. A listing of **onsemi**'s product/patent coverage may be accessed at [www.onsemi.com/site/pdf/Patent-Marking.pdf](http://www.onsemi.com/site/pdf/Patent-Marking.pdf). **onsemi** reserves the right to make changes at any time to any products or information herein, without notice. The information herein is provided "as-is" and **onsemi** makes no warranty, representation or guarantee regarding the accuracy of the information, product features, availability, functionality, or suitability of its products for any particular purpose, nor does **onsemi** assume any liability arising out of the application or use of any product or circuit, and specifically disclaims any and all liability, including without limitation special, consequential or incidental damages. Buyer is responsible for its products and applications using **onsemi** products, including compliance with all laws, regulations and safety requirements or standards, regardless of any support or applications information provided by **onsemi**. "Typical" parameters which may be provided in **onsemi** data sheets and/or specifications can and do vary in different applications and actual performance may vary over time. All operating parameters, including "Typicals" must be validated for each customer application by customer's technical experts. **onsemi** does not convey any license under any of its intellectual property rights nor the rights of others. **onsemi** products are not designed, intended, or authorized for use as a critical component in life support systems or any FDA Class 3 medical devices or medical devices with a same or similar classification in a foreign jurisdiction or any devices intended for implantation in the human body. Should Buyer purchase or use **onsemi** products for any such unintended or unauthorized application, Buyer shall indemnify and hold **onsemi** and its officers, employees, subsidiaries, affiliates, and distributors harmless against all claims, costs, damages, and expenses, and reasonable attorney fees arising out of, directly or indirectly, any claim of personal injury or death associated with such unintended or unauthorized use, even if such claim alleges that **onsemi** was negligent regarding the design or manufacture of the part. **onsemi** is an Equal Opportunity/Affirmative Action Employer. This literature is subject to all applicable copyright laws and is not for resale in any manner.

## PUBLICATION ORDERING INFORMATION

### LITERATURE FULFILLMENT:

Email Requests to: [orderlit@onsemi.com](mailto:orderlit@onsemi.com)

**onsemi Website:** [www.onsemi.com](http://www.onsemi.com)

### TECHNICAL SUPPORT

**North American Technical Support:**

Voice Mail: 1 800-282-9855 Toll Free USA/Canada

Phone: 011 421 33 790 2910

**Europe, Middle East and Africa Technical Support:**

Phone: 00421 33 790 2910

For additional information, please contact your local Sales Representative