

10 ROW  
10 POSITION  
SHOWN

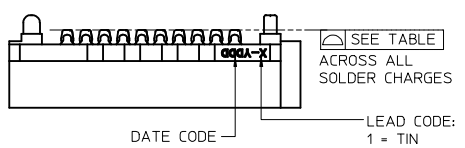

NOTE: THESE CODES MAY BE LOCATED ON EITHER SIDE OF THE HOUSING

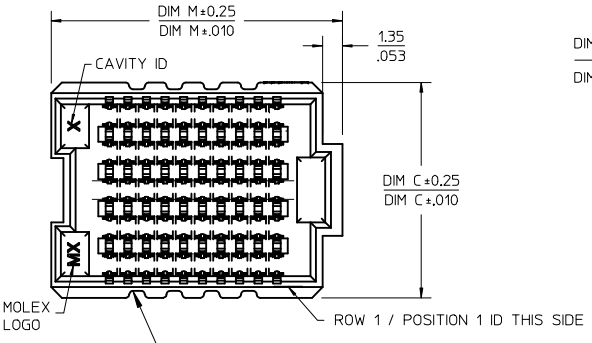

SEE SHEET 3 FOR  
6 ROW GEOMETRY

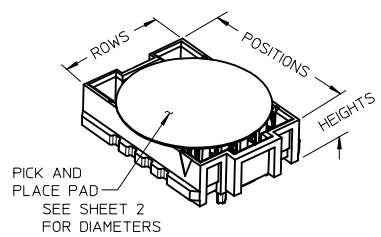
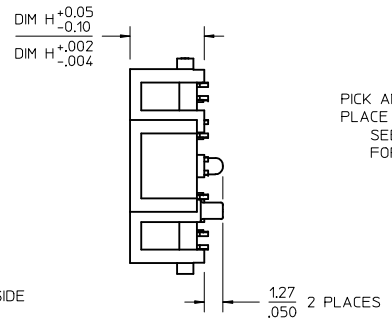

NOTES:

- MATERIALS: HOUSING: GLASS FILLED LCP (LIQUID CRYSTAL POLYMER), UL94V-0, BLACK  
CONTACTS: COPPER ALLOY  
SOLDER CHARGE: 95% TIN, 3.8% SILVER, 0.7% COPPER
- FINISH: SELECT GOLD IN CONTACT AREA: 30 MICROINCH MINIMUM  
SELECT TIN IN TAIL, 50 MICROINCH MINIMUM  
OVERALL NICKEL UNDERPLATE
- PRODUCT SPECIFICATION: PS-45970-001
- PACKAGING SPECIFICATION: PK-45971-002 (TAPE AND REEL)
- MATES WITH SEARAY PLUG ASSEMBLY SERIES 45970
- APPLICATION SPECIFICATION: AS-45970-001
- COSMETIC SPECIFICATION: PS-45499-002 CLASS B
- PART STATUS: CONTACT MOLEX

POSITIONS	TOTAL NUMBER OF EDGE NOTCHES	
10	8	0.15/.006
15	14	
20	18	
25	24	
30	28	
35	34	0.23/.009
40	38	
45	44	
50	48	

CLARIFY OVERALL LENGTH EC NO: UCP2015-5493 DRWNS:VANG01 2015/06/15 CHKD:TIBARRA 2015/08/04 APPR:SMILLER 2015/08/07	QUALITY SYMBOLS ▽=0 ▽=0 ▽=0	GENERAL TOLERANCES (UNLESS SPECIFIED) mm INCH 4 PLACES ± --- ± --- 3 PLACES ± --- ± .010 2 PLACES ± 0.25 ± .015 1 PLACE ± 0.38 ± --- 0 PLACE ± ±	DIMENSION STYLE MM/IN DRAWN BY DATE TGREGORI 2005/05/17 CHECKED BY DATE JCOMERCI 2005/05/17 APPROVED BY DATE JCOMERCI 2010/03/05	SCALE 3:1 DESIGN UNITS INCH THIRD ANGLE PROJECTION	TITLE SEARAY RECEPTACLE ASSEMBLY 1.27/.050 CENTERS molex	MATERIAL NO. SEE TABLES SHT 4 SIZE B	DOCUMENT NO. SD-45971-001	SHEET NO. 1 OF 4
	DRAFT WHERE APPLICABLE MUST REMAIN WITHIN DIMENSIONS	ANGULAR ± --- °	THIS DRAWING CONTAINS INFORMATION THAT IS PROPRIETARY TO MOLEX INCORPORATED AND SHOULD NOT BE USED WITHOUT WRITTEN PERMISSION					

10 9 8 7 6 5 4 3 2 1

10 ROW  
10 POSITION  
SHOWN

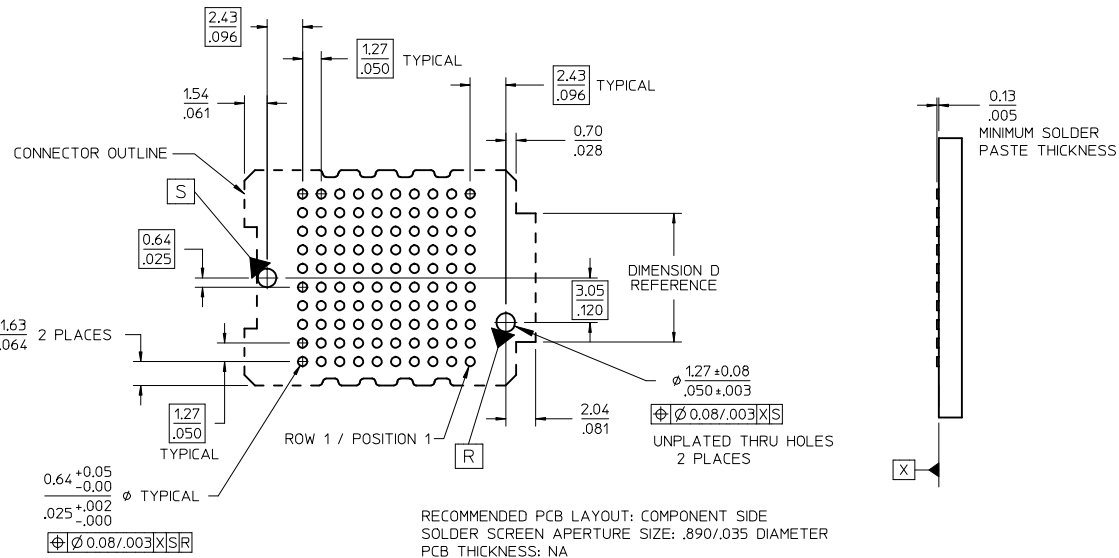

NUMBER OF ROWS	DIMENSION D
6	SEE SHEET 3
8	3.70/.146
10	6.24/.246

RECOMMENDED PCB LAYOUT: COMPONENT SIDE  
SOLDER SCREEN APERTURE SIZE: .890/.035 DIAMETER  
PCB THICKNESS: NA

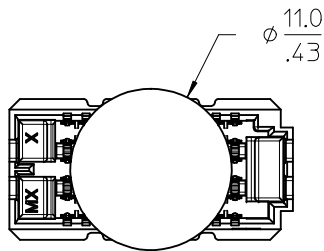

6 ROW OPTION

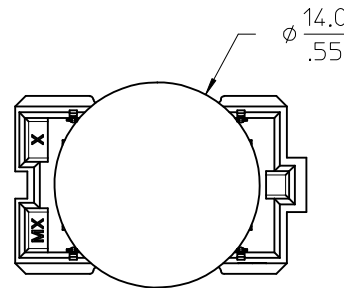

8 ROW OPTION

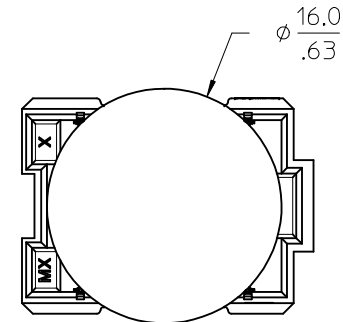

10 ROW OPTION

PICK AND PLACE  
PAD DIAMETERS  
10 POSITION VERSIONS SHOWN

SEE SHEET 1 EC NO: UCP2015-5493 DRWN: SVANG01 2015/06/25 CHKD: TIBARRA 2015/08/04 APPR: SMILLER 2015/08/07	QUALITY SYMBOLS	GENERAL TOLERANCES (UNLESS SPECIFIED)	DIMENSION STYLE	SCALE	DESIGN UNITS	THIRD ANGLE PROJECTION
	$\nabla F=0$ $\nabla E=0$ $\nabla F=0$	mm INCH 4 PLACES ± --- ± --- 3 PLACES ± --- ± .010 2 PLACES ± 0.25 ± .015 1 PLACE ± 0.38 ± --- 0 PLACE ± ±	MM/IN	3:1	INCH	
	DRAWN BY: TGREGORI CHECKED BY: JCOMERC I APPROVED BY: JCOMERC I	DATE: 2005/05/17 DATE: 2005/05/17 DATE: 2010/03/05	MATERIAL NO.	SEE TABLES SHT 4	DOCUMENT NO.	TITLE SEARAY RECEPTACLE ASSEMBLY 1.27/.050 CENTERS <b>molex</b>
	REV X	ANGULAR ± --- ° DRAFT WHERE APPLICABLE MUST REMAIN WITHIN DIMENSIONS	SIZE B	THIS DRAWING CONTAINS INFORMATION THAT IS PROPRIETARY TO MOLEX INCORPORATED AND SHOULD NOT BE USED WITHOUT WRITTEN PERMISSION	SD-45971-001	SHEET NO. 2 OF 4

9 8 7 6 5 4 3 2 1



ROWS: 6 DIMENSION C = 9.60/.378 DIMENSION D = 5.69/.224

DIM R: (REF)		5.0 MM	6.0 MM	6.5 MM	7.5 MM	8.0 MM
DIM H:		5.05/.199	6.04/.238	6.66/.258	7.54/.297	8.05/.317
POSITION	DIM M	MATERIAL NO	MATERIAL NO	MATERIAL NO	MATERIAL NO	MATERIAL NO
10	19.35/0.762	45971-1165	45971-1265	45971-1365	45971-1465	45971-1565
20	32.05/1.262	45971-2165	45971-2265	45971-2365	45971-2465	45971-2565
30	44.75/1.762	45971-3165	45971-3265	45971-3365	45971-3465	45971-3565
40	57.45/2.262	45971-4165	45971-4265	45971-4365	45971-4465	45971-4565
50	70.15/2.762	45971-5165	45971-5265	45971-5365	45971-5465	45971-5565
15	25.70/1.012	45971-6165	45971-6265	45971-6365	45971-6465	45971-6565
25	38.40/1.512	45971-7165	45971-7265	45971-7365	45971-7465	45971-7565
35	51.10/2.012	45971-8165	45971-8265	45971-8365	45971-8465	45971-8565
45	63.80/2.512	45971-9165	45971-9265	45971-9365	45971-9465	45971-9565

ROWS: 10 DIMENSION C = 14.68/.578 DIMENSION D = 6.24/.246

DIM R: (REF)		5.0 MM	6.0 MM	6.5 MM	7.5 MM	8.0 MM
DIM H:		5.05/.199	6.04/.238	6.66/.258	7.54/.297	8.05/.317
POSITION	DIM M	MATERIAL NO	MATERIAL NO	MATERIAL NO	MATERIAL NO	MATERIAL NO
10	19.88/0.784	45971-1115	45971-1215	45971-1315	45971-1415	45971-1515
20	32.58/1.284	45971-2115	45971-2215	45971-2315	45971-2415	45971-2515
30	45.28/1.784	45971-3115	45971-3215	45971-3315	45971-3415	45971-3515
40	57.98/2.284	45971-4115	45971-4215	45971-4315	45971-4415	45971-4515
50	70.68/2.784	45971-5115	45971-5215	45971-5315	45971-5415	45971-5515
15	26.23/1.034	45971-6115	45971-6215	45971-6315	45971-6415	45971-6515
25	38.93/1.534	45971-7115	45971-7215	45971-7315	45971-7415	45971-7515
35	51.63/2.034	45971-8115	45971-8215	45971-8315	45971-8415	45971-8515
45	64.33/2.534	45971-9115	45971-9215	45971-9315	45971-9415	45971-9515

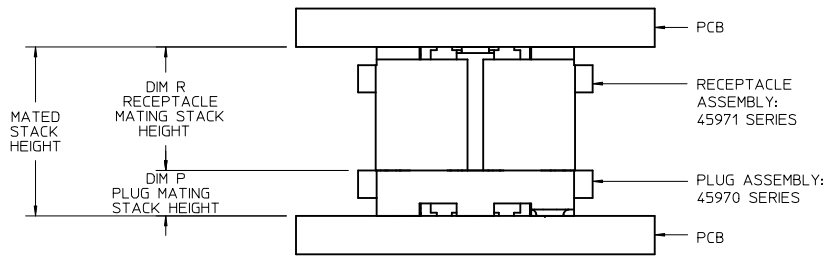

STACK HEIGHTS GIVEN IN MILLIMETERS (MM) FOR REFERENCE ONLY

ROWS: 8 DIMENSION C = 12.14/.478 DIMENSION D = 3.70/.146

DIM R: (REF)		5.0 MM	6.0 MM	6.5 MM	7.5 MM	8.0 MM
DIM H:		5.05/.199	6.04/.238	6.66/.258	7.54/.297	8.05/.317
POSITION	DIM M	MATERIAL NO	MATERIAL NO	MATERIAL NO	MATERIAL NO	MATERIAL NO
10	19.88/0.784	45971-1185	45971-1285	45971-1385	45971-1485	45971-1585
20	32.58/1.284	45971-2185	45971-2285	45971-2385	45971-2485	45971-2585
30	45.28/1.784	45971-3185	45971-3285	45971-3385	45971-3485	45971-3585
40	57.98/2.284	45971-4185	45971-4285	45971-4385	45971-4485	45971-4585
50	70.68/2.784	45971-5185	45971-5285	45971-5385	45971-5485	45971-5585
15	26.23/1.034	45971-6185	45971-6285	45971-6385	45971-6485	45971-6585
25	38.93/1.534	45971-7185	45971-7285	45971-7385	45971-7485	45971-7585
35	51.63/2.034	45971-8185	45971-8285	45971-8385	45971-8485	45971-8585
45	64.33/2.534	45971-9185	45971-9285	45971-9385	45971-9485	45971-9585

MATING STACK HEIGHTS (DIMENSION R) GIVEN IN MILLIMETERS (MM) FOR REFERENCE ONLY

DIM P PLUG STACK HEIGHT	DIM R RECEPTACLE STACK HEIGHT					
	MM	5.0	6.0	6.5	7.5	8.0
2.0	7.0	8.0	8.5	9.5	10.0	
3.0	8.0	9.0	9.5	10.5	11.0	
3.5	8.5	9.5	10.0	11.0	11.5	
2.5	7.5	8.5	9.0	10.0	10.5	
4.5	9.5	10.5	11.0	12.0	12.5	
5.0	10.0	11.0	11.5	12.5	13.0	
7.0	12.0	13.0	13.5	14.5	15.0	

MATED STACK HEIGHTS GIVEN IN MILLIMETERS (MM) FOR REFERENCE ONLY

<b>SEE SHEET 1</b> EC NO: UCP2015-5493 DRWNS:VANG01 2015/06/25 CHKD:TIBARRA 2015/08/04 APPR:SMILLER 2015/08/07 X	QUALITY SYMBOLS ∇=0 ∇=0 ∇=0	GENERAL TOLERANCES (UNLESS SPECIFIED)		DIMENSION STYLE MM/IN		SCALE 1:1	DESIGN UNITS INCH	THIRD ANGLE PROJECTION
		4 PLACES ± --- ± --- 3 PLACES ± --- ± .010 2 PLACES ± 0.25 ± .015 1 PLACE ± 0.38 ± --- 0 PLACE ± ±	DRAWN BY TGREGORI	DATE 2005/05/17	TITLE SEARAY RECEPTACLE ASSEMBLY 1.27/.050 CENTERS			
		ANGULAR ± ---° DRAFT WHERE APPLICABLE MUST REMAIN WITHIN DIMENSIONS	CHECKED BY JCOMERC I	DATE 2005/05/17	APPROVED BY JCOMERC I			
		MATERIAL NO. SEE TABLES	DATE 2010/03/05	DOCUMENT NO. SD-45971-001	SHEET NO. 4 OF 4			

THIS DRAWING CONTAINS INFORMATION THAT IS PROPRIETARY TO MOLEX INCORPORATED AND SHOULD NOT BE USED WITHOUT WRITTEN PERMISSION