

# Six-Pack Trench IGBT

 $V_{CES} = 1200\text{ V}$ 
 $I_{C25} = 110\text{ A}$ 
 $V_{CE(sat)} = 1.7\text{ V}$ 

**Part name** (Marking on product)

MWI75-12T8T

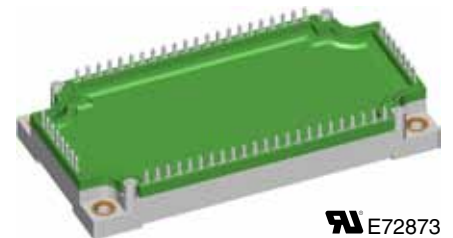
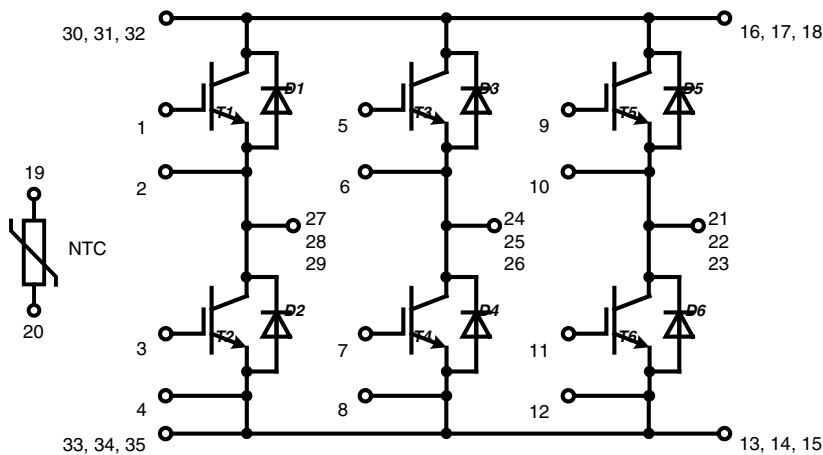

**IXYS** E72873  
Pin configuration see outlines.

**Features:**

- Trench IGBT technology
- low saturation voltage
- low switching losses
- square RBSOA, no latch up
- high short circuit capability
- positive temperature coefficient for easy paralleling
- MOS input, voltage controlled
- ultra fast free wheeling diodes
- solderable pins for PCB mounting
- package with copper base plate

**Application:**

- AC motor drives
- Solar inverter
- Medical equipment
- Uninterruptible power supply
- Air-conditioning systems
- Welding equipment
- Switched-mode and resonant-mode power supplies

**Package:**

- "E3-Pack" standard outline
- Insulated copper base plate
- Soldering pins for PCB mounting
- Temperature sense included

**Output Inverter T1 - T6**

Symbol	Definitions	Conditions	Ratings			Unit	
			min.	typ.	max.		
$V_{CES}$	collector emitter voltage		$T_{VJ} = 25^{\circ}\text{C}$		1200	V	
$V_{GES}$	max. DC gate voltage	continuous			$\pm 20$	V	
$V_{GEM}$	max. transient collector gate voltage	transient			$\pm 30$	V	
$I_{C25}$	collector current		$T_C = 25^{\circ}\text{C}$		110	A	
$I_{C80}$			$T_C = 80^{\circ}\text{C}$		75	A	
$P_{tot}$	total power dissipation		$T_C = 25^{\circ}\text{C}$		360	W	
$V_{CE(sat)}$	collector emitter saturation voltage	$I_C = 75\text{ A}; V_{GE} = 15\text{ V}$	$T_{VJ} = 25^{\circ}\text{C}$ $T_{VJ} = 125^{\circ}\text{C}$	1.7 2.0	2.1	V V	
$V_{GE(th)}$	gate emitter threshold voltage	$I_C = 3\text{ mA}; V_{GE} = V_{CE}$	$T_{VJ} = 25^{\circ}\text{C}$	5.0	5.8	6.5	V
$I_{CES}$	collector emitter leakage current	$V_{CE} = V_{CES}; V_{GE} = 0\text{ V}$	$T_{VJ} = 25^{\circ}\text{C}$ $T_{VJ} = 125^{\circ}\text{C}$		3	mA mA	
$I_{GES}$	gate emitter leakage current	$V_{GE} = \pm 20\text{ V}$			500	nA	
$C_{ies}$	input capacitance	$V_{CE} = 25\text{ V}; V_{GE} = 0\text{ V}; f = 1\text{ MHz}$			5350	pF	
$Q_{G(on)}$	total gate charge	$V_{CE} = 600\text{ V}; V_{GE} = 15\text{ V}; I_C = 75\text{ A}$			420	nC	
$t_{d(on)}$	turn-on delay time	inductive load $V_{CE} = 600\text{ V}; I_C = 75\text{ A}$ $V_{GE} = \pm 15\text{ V}; R_G = 4.7\ \Omega$ $L_S = 70\text{ nH}$	$T_{VJ} = 125^{\circ}\text{C}$		270	ns	
$t_r$	current rise time				50	ns	
$t_{d(off)}$	turn-off delay time				400	ns	
$t_f$	current fall time				340	ns	
$E_{on}$	turn-on energy per pulse				7	mJ	
$E_{off}$	turn-off energy per pulse				10	mJ	
<b>RBSOA</b>	reverse bias safe operating area	$V_{GE} = \pm 15\text{ V}; R_G = 4.7\ \Omega;$	$T_{VJ} = 125^{\circ}\text{C}$ $V_{CEK} = 1200\text{ V}$		150	A	
<b>SCSOA</b>	short circuit safe operating area		$T_{VJ} = 125^{\circ}\text{C}$		10	$\mu\text{s}$	
$t_{SC}$	short circuit duration	$V_{CE} = 900\text{ V}; V_{GE} = \pm 15\text{ V};$			300	$\mu\text{s}$	
$I_{SC}$	short circuit current	$R_G = 4.7\ \Omega; \text{non-repetitive}$				A	
$R_{thJC}$	thermal resistance junction to case	(per IGBT)			0.35	K/W	

**Output Inverter D1 - D6**

Symbol	Definitions	Conditions	Ratings			Unit
			min.	typ.	max.	
$V_{RRM}$	max. repetitive reverse voltage		$T_{VJ} = 25^{\circ}\text{C}$		1200	V
$I_{F25}$	forward current		$T_C = 25^{\circ}\text{C}$		135	A
$I_{F80}$			$T_C = 80^{\circ}\text{C}$		90	A
$V_F$	forward voltage	$I_F = 100\text{ A}; V_{GE} = 0\text{ V}$	$T_{VJ} = 25^{\circ}\text{C}$ $T_{VJ} = 125^{\circ}\text{C}$	1.95 1.95	2.2	V V
$Q_{rr}$	reverse recovery charge	$V_R = 600\text{ V}$ $di_f/dt = -1600\text{ A}/\mu\text{s}$ $I_F = 100\text{ A}; V_{GE} = 0\text{ V}$	$T_{VJ} = 125^{\circ}\text{C}$		12.5	$\mu\text{C}$
$I_{RM}$	max. reverse recovery current				100	A
$t_{rr}$	reverse recovery time				350	ns
$E_{rec}$	reverse recovery energy				4	mJ
$R_{thJC}$	thermal resistance junction to case	(per diode)			0.4	K/W

 $T_C = 25^{\circ}\text{C}$  unless otherwise stated

**Temperature Sensor NTC**

Symbol	Definitions	Conditions	Ratings			Unit
			min.	typ.	max.	
$R_{25}$	resistance	$T_C = 25^\circ\text{C}$	4.75	5.0	5.25	k $\Omega$
$B_{25/50}$				3375		K

**Module**

Symbol	Definitions	Conditions	Ratings			Unit
			min.	typ.	max.	
$T_{VJ}$	operating temperature		-40		125	$^\circ\text{C}$
$T_{VJM}$	max. virtual junction temperature				150	$^\circ\text{C}$
$T_{stg}$	storage temperature		-40		125	$^\circ\text{C}$
$V_{ISOL}$	isolation voltage	$I_{ISOL} \leq 1 \text{ mA}; 50/60 \text{ Hz}$			2500	V~
<b>CTI</b>	comparative tracking index				200	
$M_d$	mounting torque (M5)		2.7		3.3	Nm
$d_S$	creep distance on surface		10			mm
$d_A$	strike distance through air		7.5			mm
$R_{pin-chip}$	resistance pin to chip			2.5		m $\Omega$
$R_{thCH}$	thermal resistance case to heatsink	with heatsink compound		0.02		K/W
<b>Weight</b>				300		g

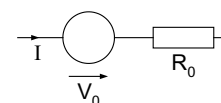
**0.0 Equivalent Circuits for Simulation**

**Ratings**

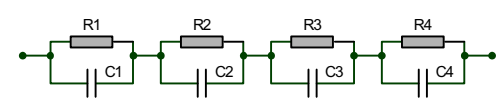
Symbol	Definitions	Conditions	min.	typ.	max.	Unit
$V_0$ $R_0$	IGBT	T1 - T6 $T_{VJ} = 125^\circ\text{C}$		1.0 13.3		V m $\Omega$
$V_0$ $R_0$	Diode	D1 - D6 $T_{VJ} = 150^\circ\text{C}$		1.09 9.1		V m $\Omega$



$$Z_{th}(t) = \sum_{i=1}^n \left[ R_i \cdot \left( 1 - \exp\left(-\frac{t}{\tau_i}\right) \right) \right]$$

$$\tau_i = R_i \cdot C_i$$

	IGBT	Diode
$R_1$	0.056	0.084
$R_2$	0.071	0.069
$R_3$	0.123	0.146
$R_4$	0.100	0.101
$\tau_1$	0.0025	0.0025
$\tau_2$	0.076	0.076
$\tau_3$	0.036	0.036
$\tau_4$	0.076	0.076

 $T_C = 25^\circ\text{C}$  unless otherwise stated

### Circuit Diagram

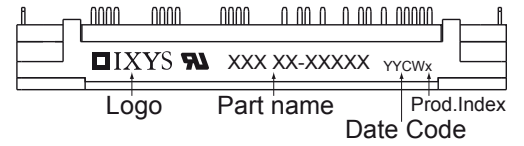
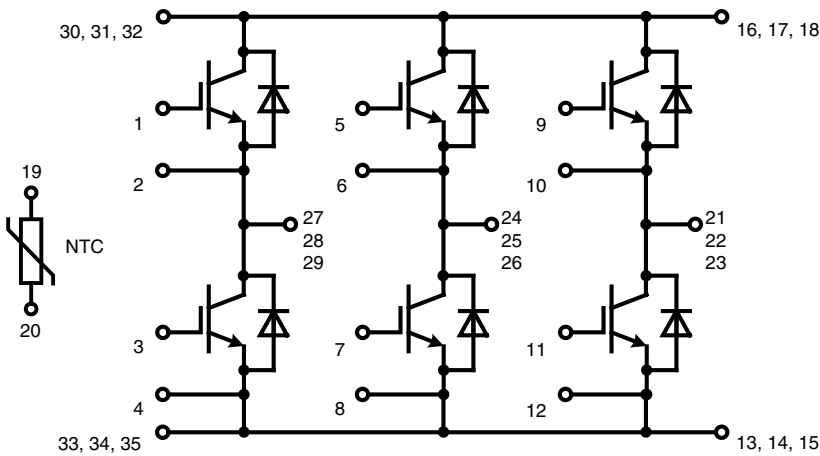

### Outline Drawing

Dimensions in mm (1 mm = 0.0394")

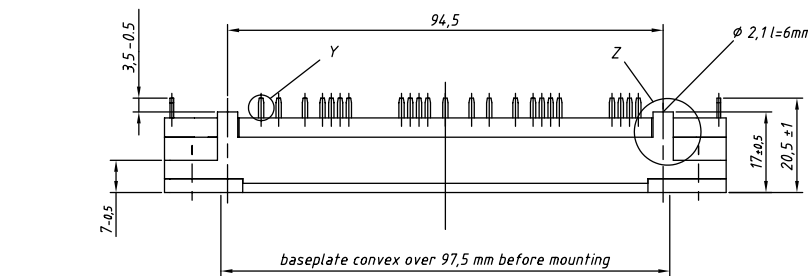

Detail X

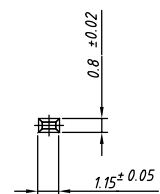

Detail Y

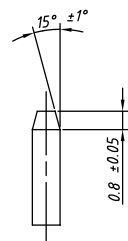

Detail Z

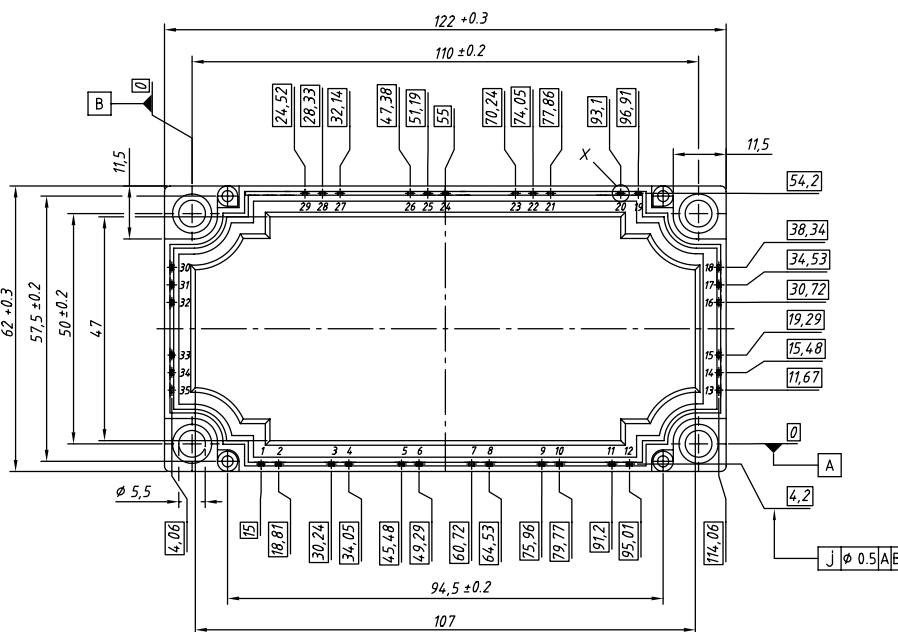
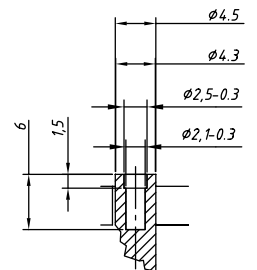

### Product Marking

Ordering	Part Name	Marking on Product	Delivering Mode	Base Qty	Ordering Code
Standard	MWI75-12T8T	MWI75-12T8T	Box	5	502425

## Inverter T1 - T6

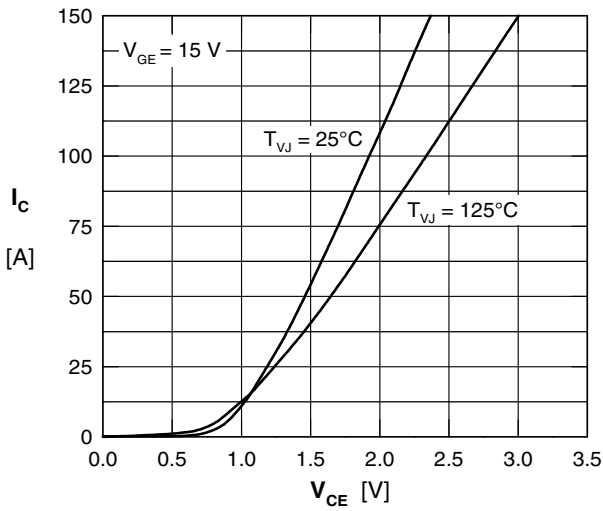

Fig. 1 Typ. output characteristics

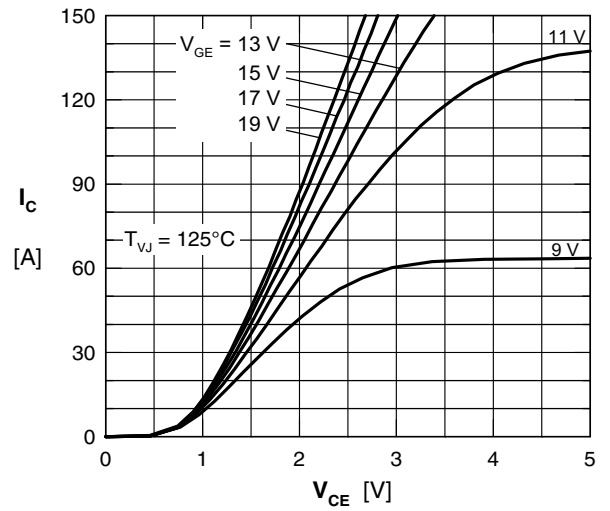

Fig. 2 output characteristics

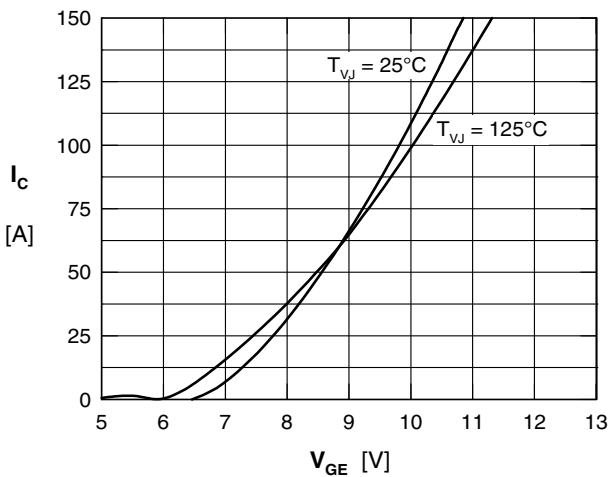

Fig. 3 Typ. transfer characteristics

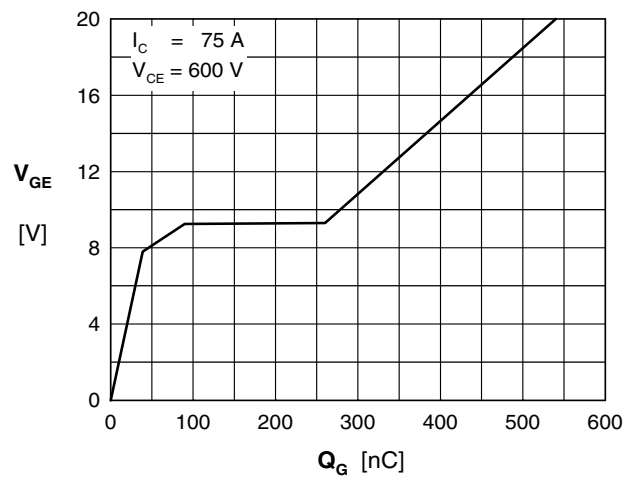

Fig. 4 Typ. turn-on gate charge

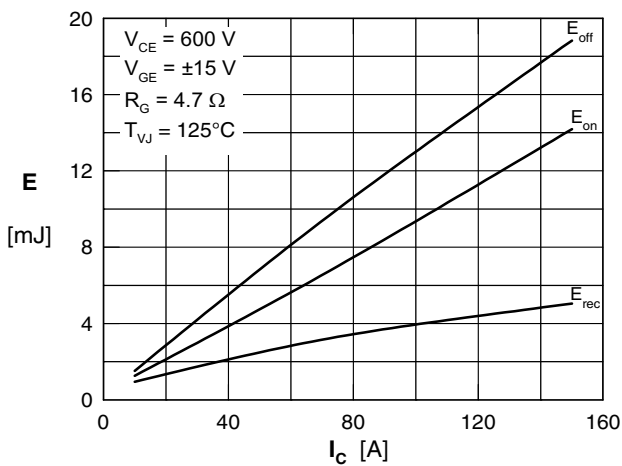

Fig. 5 Typ. switching energy vs. collector current

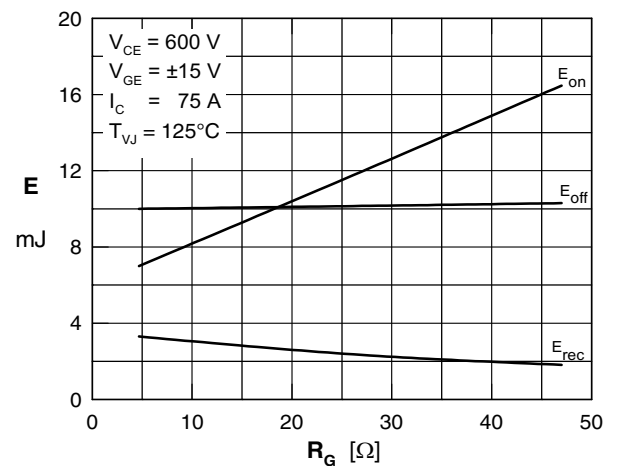

Fig. 6 Typ. switching energy vs. gate resistance

## Inverter D1 - D6

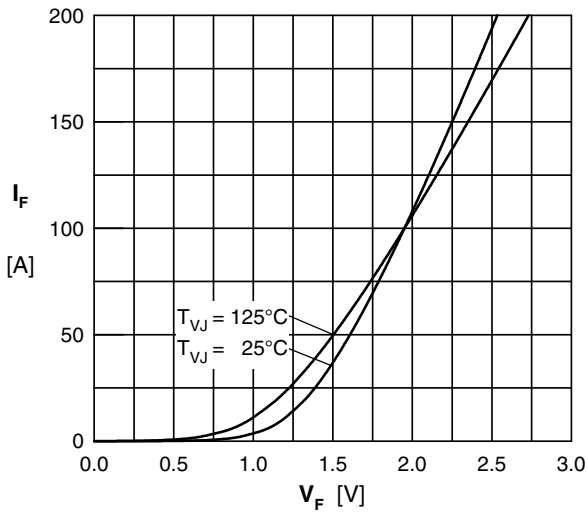

Fig. 7 Typ. Forward current versus  $V_F$

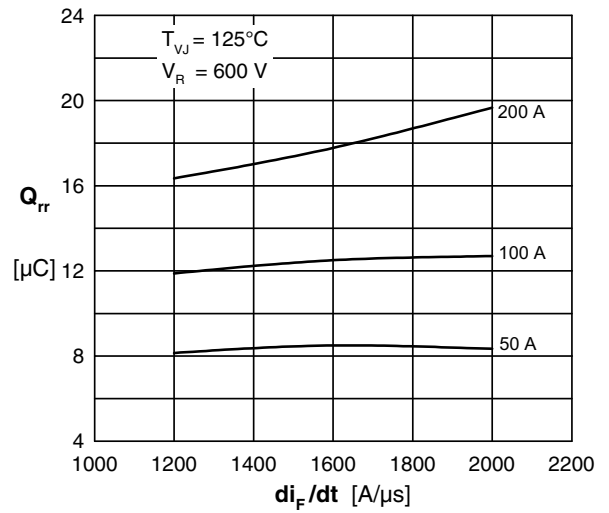

Fig. 8 Typ. reverse recov.charge  $Q_{rr}$  vs.  $di/dt$

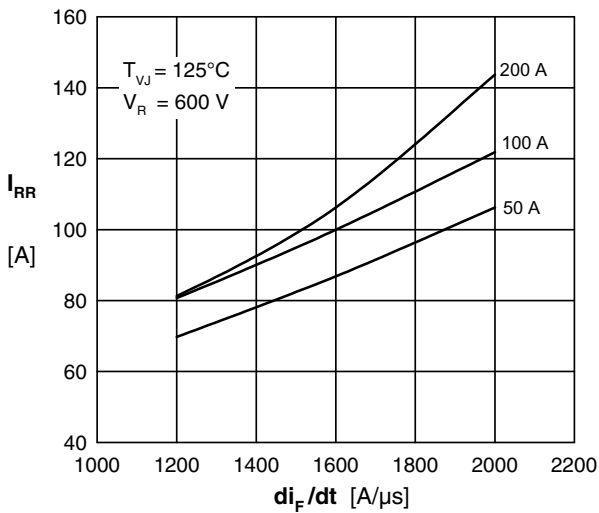

Fig. 9 Typ. peak reverse current  $I_{RM}$  vs.  $di/dt$

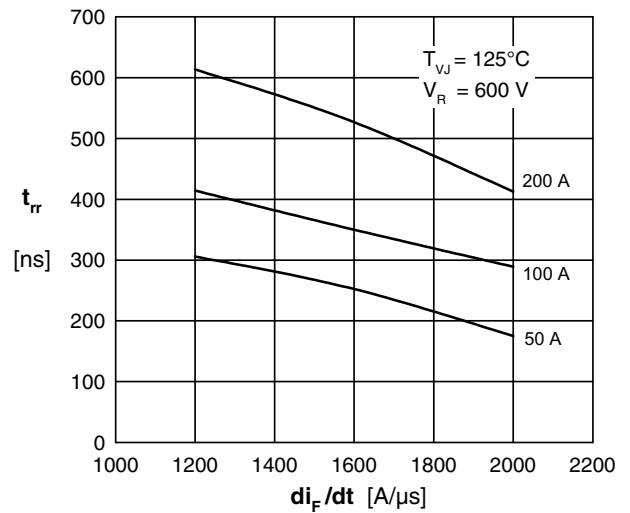

Fig. 10 Typ. recovery time  $t_{rr}$  versus  $di/dt$

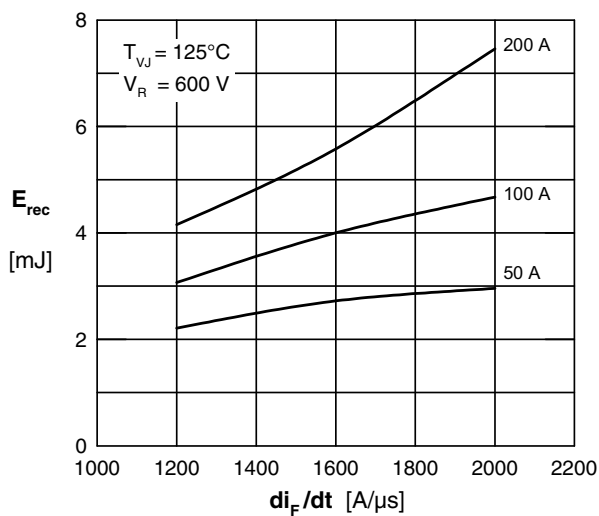

Fig. 11 Typ. recovery energy  $E_{rec}$  versus  $di/dt$

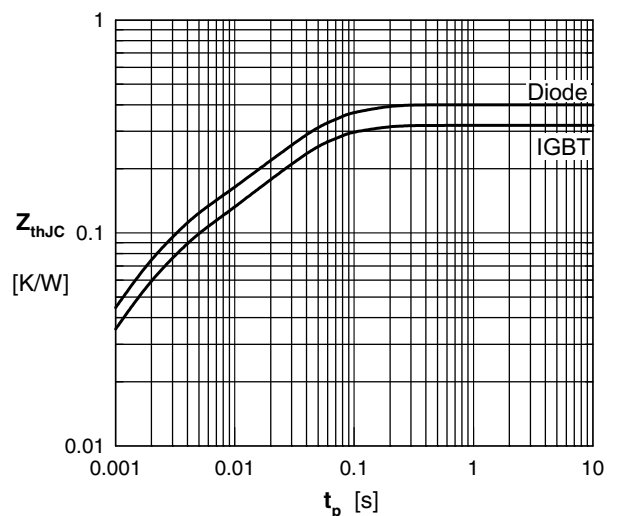

Fig. 12 Typ. transient thermal impedance

IXYS reserves the right to change limits, test conditions and dimensions.

20100910c

**NTC**

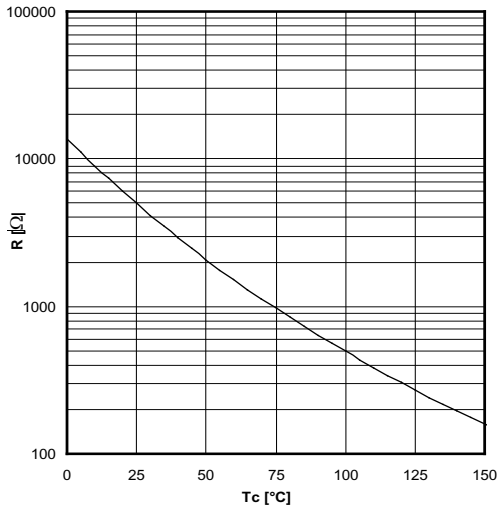

Fig. 13 Typ. NTC resistance vs. temperature