

SNx4AHC125 Quadruple Bus Buffer Gates With 3-State Outputs

1 Features

- Operating Range: 2 V to 5.5 V
- Latch-Up Performance Exceeds 250 mA Per JESD 17
- Four Individual Output Enable Pins
- All Inputs Have Schmitt-Trigger Action

2 Applications

- Flow Meters
- Programmable Logic Controllers
- Power Over Ethernet (PoE)
- Motor Drives and Controls
- Electronic Point-of-Sale

3 Description

The SNx4AHC125 devices are quadruple bus buffer gates featuring independent line drivers with 3-state outputs. Each output is disabled when the associated output-enable (\overline{OE}) input is high. When \overline{OE} is low, the respective gate passes the data from the A input to its Y output.

To ensure the high-impedance state during power up or power down, \overline{OE} must be tied to V_{CC} through a pullup resistor; the minimum value of the resistor is determined by the current-sinking capability of the driver.

Device Information⁽¹⁾

| PART NUMBER | PACKAGE (PINS) | BODY SIZE (NOM) |
|---------------|----------------|--------------------|
| SNx4AHC125FK | LCCC (20) | 8.89 mm 8.89 mm |
| SNx4AHC125DB | SSOP (14) | 6.20 mm 5.30 mm |
| SNx4AHC125D | SOIC (14) | 8.65 mm x 3.91 mm |
| SNx4AHC125NS | SO (14) | 10.30 mm x 5.30 mm |
| SNx4AHC125W | CFP (14) | 9.21 mm x 5.97 mm |
| SNx4AHC125DGV | TVSOP (14) | 3.60 mm x 4.40 mm |
| SNx4AHC125PW | TSSOP (14) | 5.00 mm x 4.40 mm |
| SNx4AHC125N | PDIP (14) | 19.30 mm x 6.35 mm |
| SNx4AHC125RGY | VQFN (14) | 3.50 mm x 3.50 mm |
| SNx4AHC125J | CDIP (14) | 19.56 mm x 6.67 mm |

(1) For all available packages, see the orderable addendum at the end of the data sheet.

Logic Diagram (Positive Logic)

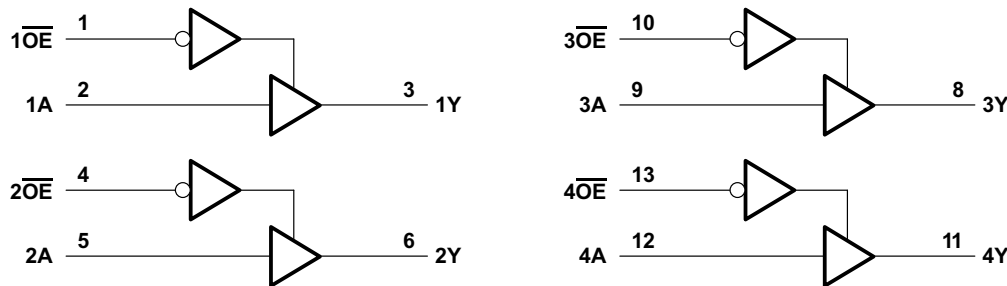

Pin numbers shown are for the D, DB, DGV, J, N, NS, PW, RGY, and W packages.



Table of Contents

| | | | |
|---|-----------|--|-----------|
| 1 Features | 1 | 8.2 Functional Block Diagram | 12 |
| 2 Applications | 1 | 8.3 Feature Description | 12 |
| 3 Description | 1 | 8.4 Device Functional Modes | 12 |
| 4 Revision History | 2 | 9 Application and Implementation | 13 |
| 5 Pin Configuration and Functions | 3 | 9.1 Application Information | 13 |
| 6 Specifications | 5 | 9.2 Typical Application | 13 |
| 6.1 Absolute Maximum Ratings | 5 | 10 Power Supply Recommendations | 15 |
| 6.2 ESD Ratings | 5 | 11 Layout | 15 |
| 6.3 Recommended Operating Conditions | 5 | 11.1 Layout Guidelines | 15 |
| 6.4 Thermal Information | 6 | 11.2 Layout Example | 15 |
| 6.5 Electrical Characteristics | 6 | 12 Device and Documentation Support | 16 |
| 6.6 Switching Characteristics: $V_{CC} = 3.3\text{ V} \pm 0.3\text{ V}$ | 8 | 12.1 Documentation Support | 16 |
| 6.7 Switching Characteristics: $V_{CC} = 5\text{ V} \pm 0.5\text{ V}$ | 9 | 12.2 Related Links | 16 |
| 6.8 Noise Characteristics | 10 | 12.3 Receiving Notification of Documentation Updates | 16 |
| 6.9 Operating Characteristics | 10 | 12.4 Community Resources | 16 |
| 6.10 Typical Characteristics | 10 | 12.5 Trademarks | 16 |
| 7 Parameter Measurement Information | 11 | 12.6 Electrostatic Discharge Caution | 16 |
| 8 Detailed Description | 12 | 12.7 Glossary | 16 |
| 8.1 Overview | 12 | 13 Mechanical, Packaging, and Orderable Information | 16 |

4 Revision History

NOTE: Page numbers for previous revisions may differ from page numbers in the current version.

| Changes from Revision K (June 2013) to Revision L | Page |
|--|----------|
| • Added <i>ESD Ratings</i> table, <i>Feature Description</i> section, <i>Device Functional Modes</i> , <i>Application and Implementation</i> section, <i>Power Supply Recommendations</i> section, <i>Layout</i> section, <i>Device and Documentation Support</i> section, and <i>Mechanical, Packaging, and Orderable Information</i> section. | 1 |
| • Deleted <i>Ordering Information</i> table; see <i>Package Option Addendum</i> at the end of the data sheet | 1 |
| • Changed Package thermal impedance, $R_{\theta JA}$, value in <i>Thermal Information</i> table From: 86°C/W To: 92.6°C/W (D), From: 96°C/W To: 107.3°C/W (DB), From: 127°C/W To: 134.6°C/W (DGV), From: 80°C/W To: 56.3°C/W (N), From: 76°C/W To: 89.9°C/W (NS), and From: 113°C/W To: 121.5°C/W (PW) | 6 |

| Changes from Revision J (December 1995) to Revision K | Page |
|---|----------|
| • Changed document format from Quicksilver to DocZone | 1 |
| • Extended operating temperature range to 125°C | 5 |

5 Pin Configuration and Functions

D, DB, DGV, N, NS, J, W, or PW Package
14-Pin SOIC, SSOP, TVSOP, PDIP, SO, CDIP, CFP, or TSSOP
Top View

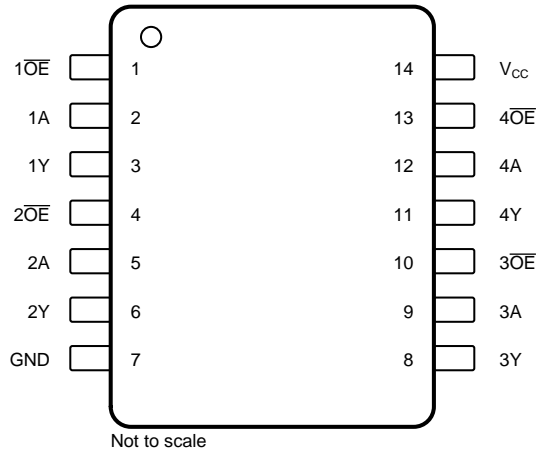

RGY Package
14-Pin VQFN
Top View

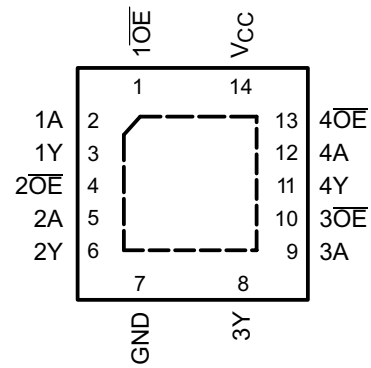

FK Package
20-Pin LCCC
Top View

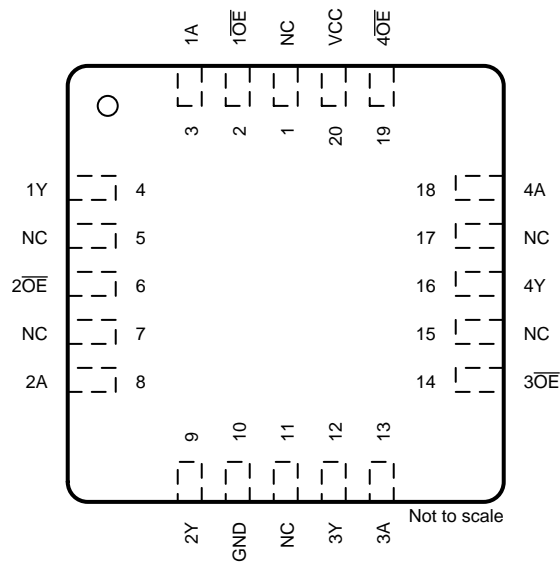

Pin Functions

| PIN | | | I/O | DESCRIPTION |
|------------------|--|------------------------|-----|--------------------------|
| NAME | SOIC, SSOP, TVSOP, PDIP, SO, CDIP, CFP, TSSOP, VQFN | LCCC | | |
| $\overline{1OE}$ | 1 | 2 | I | Output enable for gate 1 |
| 1A | 2 | 3 | I | Gate 1 input |
| 1Y | 3 | 4 | O | Gate 1 output |
| $\overline{2OE}$ | 4 | 6 | I | Output enable for gate 2 |
| 2A | 5 | 8 | I | Gate 2 input |
| 2Y | 6 | 9 | O | Gate 2 output |
| $\overline{3OE}$ | 10 | 14 | I | Output enable for gate 3 |
| 3A | 9 | 13 | I | Gate 3 input |
| 3Y | 8 | 12 | O | Gate 3 output |
| $\overline{4OE}$ | 13 | 19 | I | Output enable for gate 4 |
| 4A | 12 | 18 | I | Gate 4 input |
| 4Y | 11 | 16 | O | Gate 4 output |
| GND | 7 | 10 | — | Ground pin |
| NC | — | 1, 5, 7, 11, 15, 17 | — | No internal connection |
| V _{CC} | 14 | 20 | — | Power pin |

6 Specifications

6.1 Absolute Maximum Ratings

over operating free-air temperature range (unless otherwise noted)⁽¹⁾

| | | MIN | MAX | UNIT |
|---|-----------------------------|------|----------------|------|
| Supply voltage | | -0.5 | 7 | V |
| Input voltage ⁽²⁾ | | -0.5 | 7 | V |
| Output voltage ⁽²⁾ | | -0.5 | $V_{CC} + 0.5$ | V |
| Input clamp current | $V_I < 0$ | | -20 | mA |
| Output clamp current | $V_O < 0$ or $V_O > V_{CC}$ | | ± 20 | mA |
| Continuous output current | $V_O = 0$ to V_{CC} | | ± 25 | mA |
| Continuous current through V_{CC} or GND | | | ± 50 | mA |
| Virtual operating junction temperature, T_J | | | 150 | °C |
| Storage temperature, T_{stg} | | -65 | 150 | °C |

- (1) Stresses beyond those listed under *Absolute Maximum Ratings* may cause permanent damage to the device. These are stress ratings only, which do not imply functional operation of the device at these or any other conditions beyond those indicated under *Recommended Operating Conditions*. Exposure to absolute-maximum-rated conditions for extended periods may affect device reliability.
- (2) The input and output voltage ratings may be exceeded if the input and output current ratings are observed.

6.2 ESD Ratings

| | | VALUE | UNIT |
|-------------------------------------|--|------------|------|
| $V_{(ESD)}$ Electrostatic discharge | Human-body model (HBM), per ANSI/ESDA/JEDEC JS-001 ⁽¹⁾ | ± 1500 | V |
| | Charged-device model (CDM), per JEDEC specification JESD22-C101 ⁽²⁾ | ± 1000 | |

- (1) JEDEC document JEP155 states that 500-V HBM allows safe manufacturing with a standard ESD control process.
- (2) JEDEC document JEP157 states that 250-V CDM allows safe manufacturing with a standard ESD control process.

6.3 Recommended Operating Conditions

over operating free-air temperature range (unless otherwise noted)

| | | MIN | MAX | UNIT |
|--|------------------------------|------|----------|---------|
| V_{CC} Supply voltage | | 2 | 5.5 | V |
| V_{IH} High-level input voltage | $V_{CC} = 2$ V | 1.5 | | V |
| | $V_{CC} = 3$ V | 2.1 | | |
| | $V_{CC} = 5.5$ V | 3.85 | | |
| V_{IL} Low-level Input voltage | $V_{CC} = 2$ V | | 0.5 | V |
| | $V_{CC} = 3$ V | | 0.9 | |
| | $V_{CC} = 5.5$ V | | 1.65 | |
| V_I Input voltage | | 0 | 5.5 | V |
| V_O Output voltage | | 0 | V_{CC} | V |
| I_{OH} High-level output current | $V_{CC} = 2$ V | | -50 | μ A |
| | $V_{CC} = 3.3$ V ± 0.3 V | | -4 | mA |
| | $V_{CC} = 5$ V ± 0.5 V | | -8 | |
| I_{OL} Low-level output current | $V_{CC} = 2$ V | | 50 | μ A |
| | $V_{CC} = 3.3$ V ± 0.3 V | | 4 | mA |
| | $V_{CC} = 5$ V ± 0.5 V | | 8 | |
| $\Delta t/\Delta v$ Input Transition rise or fall rate | $V_{CC} = 3.3$ V ± 0.3 V | | 100 | ns/V |
| | $V_{CC} = 5$ V ± 0.5 V | | 20 | |
| T_A Operating free-air temperature | | -40 | 125 | °C |

6.4 Thermal Information

| THERMAL METRIC ⁽¹⁾ | SNx4AHC125 | | | | | | | UNIT |
|---|------------|-----------|---------|-------------|------------|----------|------------|------|
| | D (SOIC) | DB (SSOP) | NS (SO) | DGV (TVSOP) | PW (TSSOP) | N (PDIP) | RGY (VQFN) | |
| | 14 PINS | 14 PINS | 14 PINS | 14 PINS | 14 PINS | 14 PINS | 14 PINS | |
| $R_{\theta JA}$ Junction-to-ambient thermal resistance | 92.6 | 107.3 | 89.9 | 134.6 | 121.5 | 56.3 | 55.1 | °C/W |
| $R_{\theta JC(top)}$ Junction-to-case (top) thermal resistance | 52.7 | 59.3 | 47.7 | 53.9 | 50.2 | 43.9 | 52.3 | °C/W |
| $R_{\theta JB}$ Junction-to-board thermal resistance | 46.8 | 54.7 | 48.6 | 63.8 | 63.2 | 36.1 | 30.9 | °C/W |
| Ψ_{JT} Junction-to-top characterization parameter | 19.7 | 24 | 17.5 | 6.3 | 6.1 | 29.2 | 2.4 | °C/W |
| Ψ_{JB} Junction-to-board characterization parameter | 46.6 | 54.1 | 48.3 | 63.2 | 62.7 | 36 | 31 | °C/W |
| $R_{\theta JC(bot)}$ Junction-to-case (bottom) thermal resistance | — | — | — | — | — | — | 12.7 | °C/W |

(1) For more information about traditional and new thermal metrics, see the [Semiconductor and IC Package Thermal Metrics](#) application report.

6.5 Electrical Characteristics

over recommended operating free-air temperature range (unless otherwise noted)

| PARAMETER | TEST CONDITIONS | | | MIN | TYP | MAX | UNIT |
|---------------------------------------|---|---|---|-----|-----|-----|------|
| V_{OH} | $I_{OH} = -50 \mu A$ | $V_{CC} = 2 V$ | $T_A = 25^\circ C$ | 1.9 | 2 | | V |
| | | | $T_A = -55^\circ C$ to $125^\circ C$ (SN54AHC125) | 1.9 | | | |
| | | | $T_A = -40^\circ C$ to $85^\circ C$ (SN74AHC125) | 1.9 | | | |
| | | | $T_A = -40^\circ C$ to $125^\circ C$ (recommended SN74AHC125) | 1.9 | | | |
| | | $V_{CC} = 3 V$ | $T_A = 25^\circ C$ | 2.9 | 3 | | |
| | | | $T_A = -55^\circ C$ to $125^\circ C$ (SN54AHC125) | 2.9 | | | |
| | | | $T_A = -40^\circ C$ to $85^\circ C$ (SN74AHC125) | 2.9 | | | |
| | | | $T_A = -40^\circ C$ to $125^\circ C$ (recommended SN74AHC125) | 2.9 | | | |
| | | $V_{CC} = 4.5 V$ | $T_A = 25^\circ C$ | 4.4 | 4.5 | | |
| | | | $T_A = -55^\circ C$ to $125^\circ C$ (SN54AHC125) | 4.4 | | | |
| | | | $T_A = -40^\circ C$ to $85^\circ C$ (SN74AHC125) | 4.4 | | | |
| | | | $T_A = -40^\circ C$ to $125^\circ C$ (recommended SN74AHC125) | 4.4 | | | |
| | $I_{OH} = -4 mA$ and $V_{CC} = 3 V$ | $T_A = 25^\circ C$ | 2.58 | | | | |
| | | $T_A = -55^\circ C$ to $125^\circ C$ (SN54AHC125) | 2.48 | | | | |
| | | $T_A = -40^\circ C$ to $85^\circ C$ (SN74AHC125) | 2.48 | | | | |
| | | $T_A = -40^\circ C$ to $125^\circ C$ (recommended SN74AHC125) | 2.48 | | | | |
| $I_{OH} = -8 mA$ and $V_{CC} = 4.5 V$ | $T_A = 25^\circ C$ | 3.94 | | | | | |
| | $T_A = -55^\circ C$ to $125^\circ C$ (SN54AHC125) | 3.8 | | | | | |
| | $T_A = -40^\circ C$ to $85^\circ C$ (SN74AHC125) | 3.8 | | | | | |
| | $T_A = -40^\circ C$ to $125^\circ C$ (recommended SN74AHC125) | 3.8 | | | | | |

Electrical Characteristics (continued)

over recommended operating free-air temperature range (unless otherwise noted)

| PARAMETER | TEST CONDITIONS | | MIN | TYP | MAX | UNIT |
|--------------------------------------|---|---|---|---------------|---------|------|
| V_{OL} | $I_{OL} = 50 \mu A$ | $V_{CC} = 2 V$ | $T_A = 25^\circ C$ | | 0.1 | V |
| | | | $T_A = -55^\circ C$ to $125^\circ C$ (SN54AHC125) | | 0.1 | |
| | | | $T_A = -40^\circ C$ to $85^\circ C$ (SN74AHC125) | | 0.1 | |
| | | | $T_A = -40^\circ C$ to $125^\circ C$ (recommended SN74AHC125) | | 0.1 | |
| | | $V_{CC} = 3 V$ | $T_A = 25^\circ C$ | | 0.1 | |
| | | | $T_A = -55^\circ C$ to $125^\circ C$ (SN54AHC125) | | 0.1 | |
| | | | $T_A = -40^\circ C$ to $85^\circ C$ (SN74AHC125) | | 0.1 | |
| | | | $T_A = -40^\circ C$ to $125^\circ C$ (recommended SN74AHC125) | | 0.1 | |
| | | $V_{CC} = 4.5 V$ | $T_A = 25^\circ C$ | | 0.1 | |
| | | | $T_A = -55^\circ C$ to $125^\circ C$ (SN54AHC125) | | 0.1 | |
| | | | $T_A = -40^\circ C$ to $85^\circ C$ (SN74AHC125) | | 0.1 | |
| | | | $T_A = -40^\circ C$ to $125^\circ C$ (recommended SN74AHC125) | | 0.1 | |
| | $I_{OH} = 4 mA$ and $V_{CC} = 3 V$ | $T_A = 25^\circ C$ | | 0.36 | | |
| | | $T_A = -55^\circ C$ to $125^\circ C$ (SN54AHC125) | | 0.5 | | |
| | | $T_A = -40^\circ C$ to $85^\circ C$ (SN74AHC125) | | 0.44 | | |
| | | $T_A = -40^\circ C$ to $125^\circ C$ (recommended SN74AHC125) | | 0.5 | | |
| $I_{OH} = 8 mA$ and $V_{CC} = 4.5 V$ | $T_A = 25^\circ C$ | | 0.36 | | | |
| | $T_A = -55^\circ C$ to $125^\circ C$ (SN54AHC125) | | 0.5 | | | |
| | $T_A = -40^\circ C$ to $85^\circ C$ (SN74AHC125) | | 0.44 | | | |
| | $T_A = -40^\circ C$ to $125^\circ C$ (recommended SN74AHC125) | | 0.5 | | | |
| I_i | $V_i = 5.5 V$ or GND and $V_{CC} = 0 V$ to $5.5 V$ | $T_A = 25^\circ C$ | | ± 0.1 | μA | |
| | | $T_A = -55^\circ C$ to $125^\circ C$ (SN54AHC125) | | $\pm 1^{(1)}$ | | |
| | | $T_A = -40^\circ C$ to $85^\circ C$ (SN74AHC125) | | ± 1 | | |
| | | $T_A = -40^\circ C$ to $125^\circ C$ (recommended SN74AHC125) | | ± 1 | | |
| I_{OZ} | $V_O = V_{CC}$ or GND and $V_{CC} = 5.5 V$ | $T_A = 25^\circ C$ | | ± 0.25 | μA | |
| | | $T_A = -55^\circ C$ to $125^\circ C$ (SN54AHC125) | | ± 2.5 | | |
| | | $T_A = -40^\circ C$ to $85^\circ C$ (SN74AHC125) | | ± 2.5 | | |
| | | $T_A = -40^\circ C$ to $125^\circ C$ (recommended SN74AHC125) | | ± 2.5 | | |
| I_{CC} | $V_i = V_{CC}$ or GND, $I_O = 0$, and $V_{CC} = 5.5 V$ | $T_A = 25^\circ C$ | | 4 | μA | |
| | | $T_A = -55^\circ C$ to $125^\circ C$ (SN54AHC125) | | 40 | | |
| | | $T_A = -40^\circ C$ to $85^\circ C$ (SN74AHC125) | | 40 | | |
| | | $T_A = -40^\circ C$ to $125^\circ C$ (recommended SN74AHC125) | | 40 | | |
| C_i | $V_i = V_{CC}$ or GND and $V_{CC} = 5 V$ | $T_A = 25^\circ C$ | | 4 | pF | |
| | | $T_A = -40^\circ C$ to $85^\circ C$ (SN74AHC125) | | 10 | | |

(1) On products compliant to MIL-PRF-38535, this parameter is not production tested at $V_{CC} = 0 V$.

6.6 Switching Characteristics: $V_{CC} = 3.3\text{ V} \pm 0.3\text{ V}$

 over recommended operating free-air temperature range and $V_{CC} = 3.3\text{ V} \pm 0.3\text{ V}$ (unless otherwise noted; see [Figure 2](#))

| PARAMETER | FROM (INPUT) | TO (OUTPUT) | TEST CONDITIONS | | MIN | TYP | MAX | UNIT |
|--------------------|-----------------|-------------|----------------------|---|------------------|--------------------|---------------------|------|
| t_{PHL}, t_{PLH} | A | Y | $C_L = 15\text{ pF}$ | $T_A = 25^\circ\text{C}$ | | 5.6 ⁽¹⁾ | 8 ⁽¹⁾ | ns |
| | | | | $T_A = -55^\circ\text{C}$ to 125°C (SN54AHC125) | 1 ⁽¹⁾ | | 9.5 ⁽¹⁾ | |
| | | | | $T_A = -40^\circ\text{C}$ to 85°C (SN74AHC125) | 1 | | 9.5 | |
| | | | | $T_A = -40^\circ\text{C}$ to 125°C (recommended SN74AHC125) | 1 | | 9.5 | |
| t_{PZL}, t_{PZH} | \overline{OE} | Y | $C_L = 15\text{ pF}$ | $T_A = 25^\circ\text{C}$ | | 5.4 ⁽¹⁾ | 8 ⁽¹⁾ | ns |
| | | | | $T_A = -55^\circ\text{C}$ to 125°C (SN54AHC125) | 1 ⁽¹⁾ | | 9.5 ⁽¹⁾ | |
| | | | | $T_A = -40^\circ\text{C}$ to 85°C (SN74AHC125) | | | 9.5 | |
| | | | | $T_A = -40^\circ\text{C}$ to 125°C (recommended SN74AHC125) | | | 9.5 | |
| t_{PLZ}, t_{PHZ} | \overline{OE} | Y | $C_L = 15\text{ pF}$ | $T_A = 25^\circ\text{C}$ | | 7.0 ⁽¹⁾ | 9.7 ⁽¹⁾ | ns |
| | | | | $T_A = -55^\circ\text{C}$ to 125°C (SN54AHC125) | 1 ⁽¹⁾ | | 11.5 ⁽¹⁾ | |
| | | | | $T_A = -40^\circ\text{C}$ to 85°C (SN74AHC125) | 1 ⁽¹⁾ | | 11.5 ⁽¹⁾ | |
| | | | | $T_A = -40^\circ\text{C}$ to 125°C (recommended SN74AHC125) | 1 ⁽¹⁾ | | 11.5 ⁽¹⁾ | |
| t_{PHL}, t_{PLH} | A | Y | $C_L = 50\text{ pF}$ | $T_A = 25^\circ\text{C}$ | | 8.1 | 11.5 | ns |
| | | | | $T_A = -55^\circ\text{C}$ to 125°C (SN54AHC125) | 1 | | 13 | |
| | | | | $T_A = -40^\circ\text{C}$ to 85°C (SN74AHC125) | 1 | | 13 | |
| | | | | $T_A = -40^\circ\text{C}$ to 125°C (recommended SN74AHC125) | 1 | | 13 | |
| t_{PZL}, t_{PZH} | \overline{OE} | Y | $C_L = 50\text{ pF}$ | $T_A = 25^\circ\text{C}$ | | 7.9 | 11.5 | ns |
| | | | | $T_A = -55^\circ\text{C}$ to 125°C (SN54AHC125) | 1 | | 13 | |
| | | | | $T_A = -40^\circ\text{C}$ to 85°C (SN74AHC125) | 1 | | 13 | |
| | | | | $T_A = -40^\circ\text{C}$ to 125°C (recommended SN74AHC125) | 1 | | 13 | |
| t_{PLZ}, t_{PHZ} | \overline{OE} | Y | $C_L = 50\text{ pF}$ | $T_A = 25^\circ\text{C}$ | | 9.5 | 13.2 | ns |
| | | | | $T_A = -55^\circ\text{C}$ to 125°C (SN54AHC125) | 1 | | 15 | |
| | | | | $T_A = -40^\circ\text{C}$ to 85°C (SN74AHC125) | 1 | | 15 | |
| | | | | $T_A = -40^\circ\text{C}$ to 125°C (recommended SN74AHC125) | 1 | | 15 | |
| tsk(o) | \overline{OE} | Y | $C_L = 50\text{ pF}$ | $T_A = 25^\circ\text{C}$ | | | 1.5 ⁽²⁾ | ns |
| | | | | $T_A = -40^\circ\text{C}$ to 85°C (SN74AHC125) | | | 1.5 | |

(1) On products compliant to MIL-PRF-38535, this parameter is not production tested.

(2) On products compliant to MIL-PRF-38535, this parameter does not apply.

6.7 Switching Characteristics: $V_{CC} = 5\text{ V} \pm 0.5\text{ V}$

 over recommended operating free-air temperature range and $V_{CC} = 5\text{ V} \pm 0.5\text{ V}$ (unless otherwise noted; see [Figure 2](#))

| PARAMETER | FROM (INPUT) | TO (OUTPUT) | TEST CONDITIONS | | MIN | TYP | MAX | UNIT |
|--------------------|-----------------|-------------|----------------------|---|------------------|--------------------|--------------------|------|
| t_{PLH}, t_{PHL} | A | Y | $C_L = 15\text{ pF}$ | $T_A = 25^\circ\text{C}$ | | 3.8 ⁽¹⁾ | 5.5 ⁽¹⁾ | ns |
| | | | | $T_A = -55^\circ\text{C}$ to 125°C (SN54AHC125) | 1 ⁽¹⁾ | | 6.5 ⁽¹⁾ | |
| | | | | $T_A = -40^\circ\text{C}$ to 85°C (SN74AHC125) | 1 | | 6.5 | |
| | | | | $T_A = -40^\circ\text{C}$ to 125°C (recommended SN74AHC125) | 1 | | 6.5 | |
| t_{PZH}, t_{PZL} | \overline{OE} | Y | $C_L = 15\text{ pF}$ | $T_A = 25^\circ\text{C}$ | | 3.6 ⁽¹⁾ | 5.1 ⁽¹⁾ | ns |
| | | | | $T_A = -55^\circ\text{C}$ to 125°C (SN54AHC125) | 1 ⁽¹⁾ | | 6 ⁽¹⁾ | |
| | | | | $T_A = -40^\circ\text{C}$ to 85°C (SN74AHC125) | 1 | | 6 | |
| | | | | $T_A = -40^\circ\text{C}$ to 125°C (recommended SN74AHC125) | 1 | | 6 | |
| t_{PHZ}, t_{PLZ} | \overline{OE} | Y | $C_L = 15\text{ pF}$ | $T_A = 25^\circ\text{C}$ | | 4.6 ⁽¹⁾ | 6.8 ⁽¹⁾ | ns |
| | | | | $T_A = -55^\circ\text{C}$ to 125°C (SN54AHC125) | 1 ⁽¹⁾ | | 8 ⁽¹⁾ | |
| | | | | $T_A = -40^\circ\text{C}$ to 85°C (SN74AHC125) | 1 ⁽¹⁾ | | 8 ⁽¹⁾ | |
| | | | | $T_A = -40^\circ\text{C}$ to 125°C (recommended SN74AHC125) | 1 ⁽¹⁾ | | 8 ⁽¹⁾ | |
| t_{PLH}, t_{PHL} | A | Y | $C_L = 50\text{ pF}$ | $T_A = 25^\circ\text{C}$ | | 5.3 | 7.5 | ns |
| | | | | $T_A = -55^\circ\text{C}$ to 125°C (SN54AHC125) | 1 | | 8.5 | |
| | | | | $T_A = -40^\circ\text{C}$ to 85°C (SN74AHC125) | 1 | | 8.5 | |
| | | | | $T_A = -40^\circ\text{C}$ to 125°C (recommended SN74AHC125) | 1 | | 8.5 | |
| t_{PZH}, t_{PZL} | \overline{OE} | Y | $C_L = 50\text{ pF}$ | $T_A = 25^\circ\text{C}$ | | 5.1 | 7.1 | ns |
| | | | | $T_A = -55^\circ\text{C}$ to 125°C (SN54AHC125) | 1 | | 8 | |
| | | | | $T_A = -40^\circ\text{C}$ to 85°C (SN74AHC125) | 1 | | 8 | |
| | | | | $T_A = -40^\circ\text{C}$ to 125°C (recommended SN74AHC125) | 1 | | 8 | |
| t_{PHZ}, t_{PLZ} | \overline{OE} | Y | $C_L = 50\text{ pF}$ | $T_A = 25^\circ\text{C}$ | | 6.1 | 8.8 | ns |
| | | | | $T_A = -55^\circ\text{C}$ to 125°C (SN54AHC125) | 1 | | 10 | |
| | | | | $T_A = -40^\circ\text{C}$ to 85°C (SN74AHC125) | 1 | | 10 | |
| | | | | $T_A = -40^\circ\text{C}$ to 125°C (recommended SN74AHC125) | 1 | | 10 | |
| $t_{sk(0)}$ | \overline{OE} | Y | $C_L = 50\text{ pF}$ | $T_A = 25^\circ\text{C}$ | | | 1 ⁽²⁾ | ns |
| | | | | $T_A = -40^\circ\text{C}$ to 85°C (SN74AHC125) | | | 1 | |

(1) On products compliant to MIL-PRF-38535, this parameter is not production tested.

(2) On products compliant to MIL-PRF-38535, this parameter does not apply.

6.8 Noise Characteristics

 $V_{CC} = 5\text{ V}$, $C_L = 50\text{ pF}$, and $T_A = 25^\circ\text{C}$ ⁽¹⁾

| PARAMETER | | MIN | MAX | UNIT |
|-------------|--|-----|------|------|
| $V_{OL(P)}$ | Quiet output, maximum dynamic (V_{OL}) | | 0.8 | V |
| $V_{OL(V)}$ | Quiet output, minimum dynamic (V_{OL}) | | -0.8 | V |
| $V_{OH(V)}$ | Quiet output, minimum dynamic (V_{OH}) | 4.4 | | V |
| $V_{IH(D)}$ | High-level dynamic input voltage | 3.5 | | V |
| $V_{IL(D)}$ | Low-level dynamic input voltage | | 1.5 | V |

(1) Characteristics are for surface-mount packages only.

6.9 Operating Characteristics

 $V_{CC} = 5\text{ V}$ and $T_A = 25^\circ\text{C}$

| PARAMETER | TEST CONDITIONS | TYP | UNIT |
|-----------|--------------------------------|-----|------|
| C_{pd} | No load and $f = 1\text{ MHz}$ | 9.5 | pF |

6.10 Typical Characteristics

Figure 1 shows I_{CC} for varying V_{IN} values when V_{CC} is $5\text{ V} \pm 0.5\text{ V}$ and $T_A = 25^\circ\text{C}$.

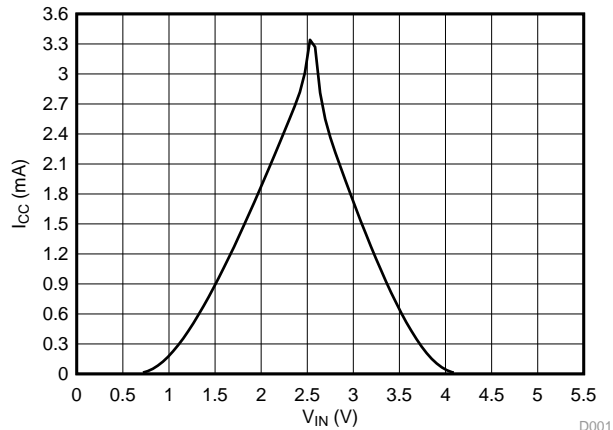
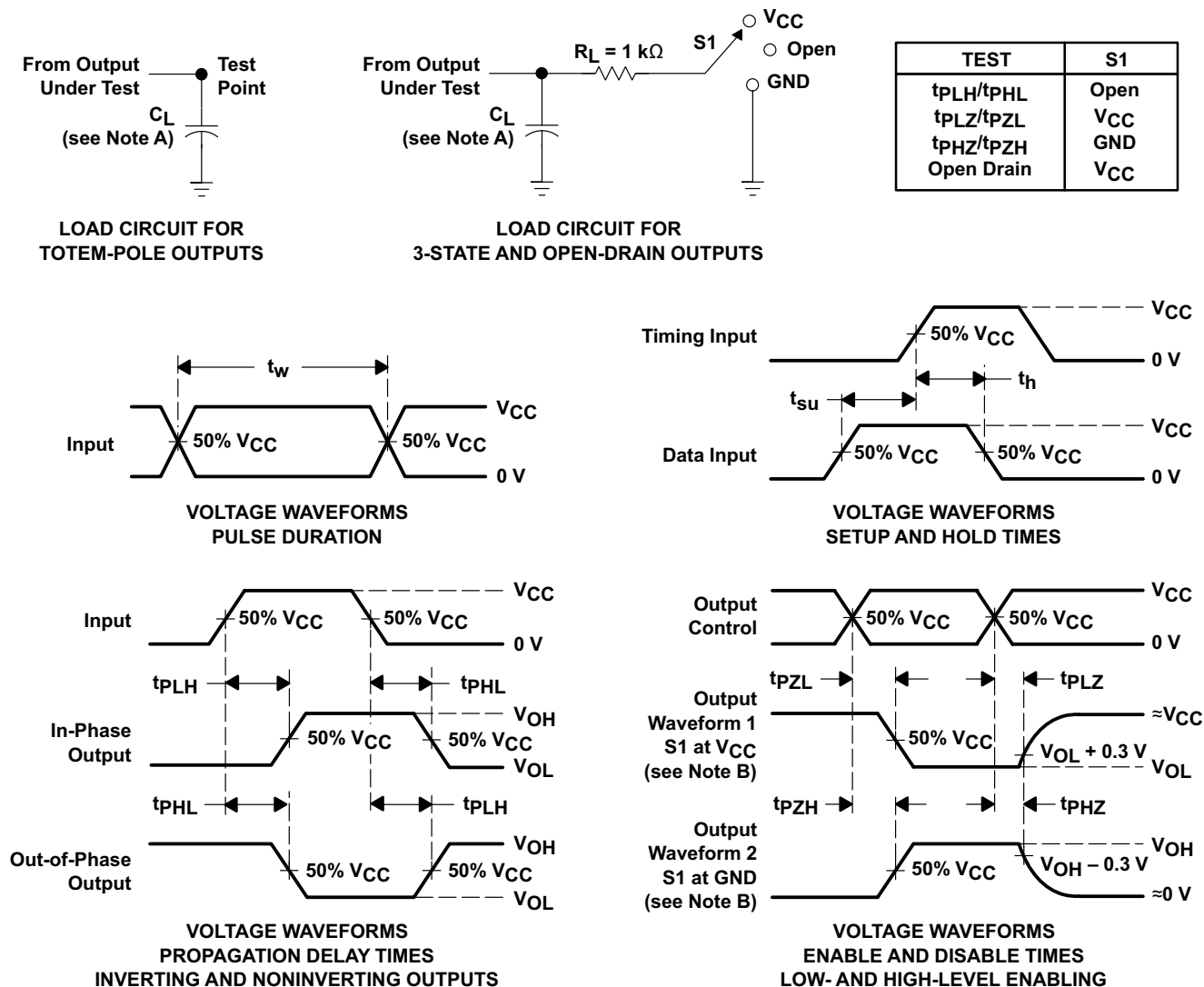

Figure 1. V_{IN} vs I_{CC}

D001

7 Parameter Measurement Information



- A. C_L includes probe and jig capacitance.
- B. Waveform 1 is for an output with internal conditions such that the output is low except when disabled by the output control. Waveform 2 is for an output with internal conditions such that the output is high except when disabled by the output control.
- C. All input pulses are supplied by generators having the following characteristics: $PRR \leq 1\text{ MHz}$, $Z_O = 50\ \Omega$, $t_r \leq 3\text{ ns}$, $t_f \leq 3\text{ ns}$.
- D. The outputs are measured one at a time with one input transition per measurement.
- E. All parameters and waveforms are not applicable to all devices.

Figure 2. Load Circuit and Voltage Waveforms

8 Detailed Description

8.1 Overview

The SNx4AHC125 devices have four integrated bus buffer gates. Each gate can be individually controlled from their respective output enable pins or tied together and controlled simultaneously. This allows for control of up to four different lines from one device. Often times a microcontroller have multiple function options for a single pin. By using GPIO pins to enable specific buffers, the SNx4AHC125 can act as a multiplexer to select a specific data line depending on what pin function is selected on the microcontroller. At the same time, the lines that are not selected are isolated from the pin.

8.2 Functional Block Diagram

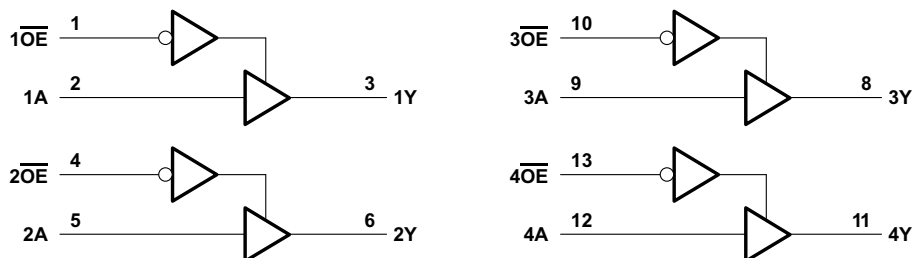

Pin numbers shown are for the D, DB, DGV, J, N, NS, PW, RGY, and W packages.

8.3 Feature Description

Each buffer has its own output enable. This allows for control of each buffer individually. When the output enable is LOW, the input is passed to the output. When the output enable is HIGH, the output is high impedance. This feature is useful in applications that might require isolation.

8.4 Device Functional Modes

Table 1 lists the functional modes of the SNx4AHC125.

**Table 1. Function Table
(Each Buffer)**

| INPUTS | | OUTPUT |
|-----------------|---|--------|
| \overline{OE} | A | Y |
| L | H | H |
| L | L | L |
| H | X | Z |

Typical Application (continued)

9.2.2 Detailed Design Procedure

1. Recommended Input Conditions:

- For V_{IH} and V_{IL} levels at varying V_{CC} , see [Recommended Operating Conditions](#).
- Be mindful of rise time and fall time specifications for the output enable pins to ensure that the right buffers are enabled and the others are disabled in time. This minimizes interference on the microcontroller pin and to exterior circuitry. See [Switching Characteristics: \$V_{CC} = 3.3\text{ V} \pm 0.3\text{ V}\$](#) and [Switching Characteristics: \$V_{CC} = 5\text{ V} \pm 0.5\text{ V}\$](#) table for more details.

2. Recommended Output Conditions:

- Load currents must not exceed I_O maximum per output and must not exceed continuous current through V_{CC} or GND total current for the part. These limits are located in the [Absolute Maximum Ratings](#).
- Outputs must not be pulled above V_{CC} .

9.2.3 Application Curves

Typical device at 25°C

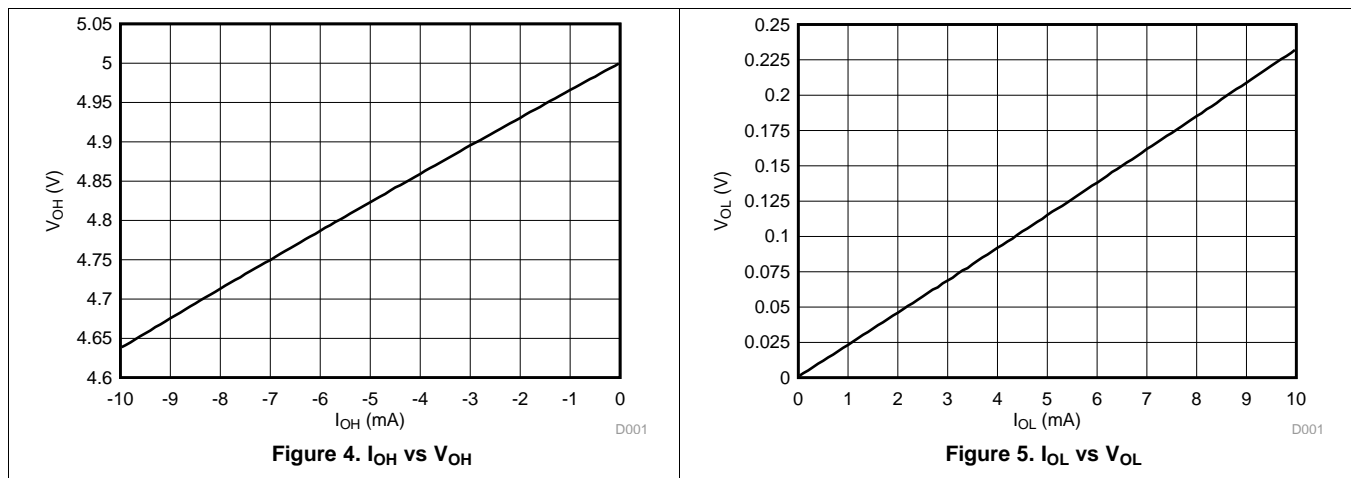

10 Power Supply Recommendations

The power supply can be any voltage between the minimum and maximum supply voltage rating located in the [Recommended Operating Conditions](#).

Each V_{CC} pin must have a good bypass capacitor to prevent power disturbance. For devices with a single supply, a 0.1- μF capacitor is recommended and if there are multiple V_{CC} pins then a 0.01- μF or 0.022- μF capacitor is recommended for each power pin. It is ok to parallel multiple bypass capacitors to reject different frequencies of noise. 0.1- μF and 1- μF capacitors are commonly used in parallel. The bypass capacitor must be installed as close to the power pin as possible for best results.

11 Layout

11.1 Layout Guidelines

When using multiple bit logic devices, inputs must not ever float. In many cases, functions or parts of functions of digital logic devices are unused; for example, when only two inputs of a triple-input AND gate are used or only 3 of the 4 buffer gates are used. Such input pins must not be left unconnected because the undefined voltages at the outside connections result in undefined operational states. Specified below are the rules that must be observed under all circumstances. All unused inputs of digital logic devices must be connected to a high or low bias to prevent them from floating. The logic level that must be applied to any particular unused input depends on the function of the device. Generally, they are tied to GND or V_{CC} (whichever make more sense or is more convenient).

11.2 Layout Example

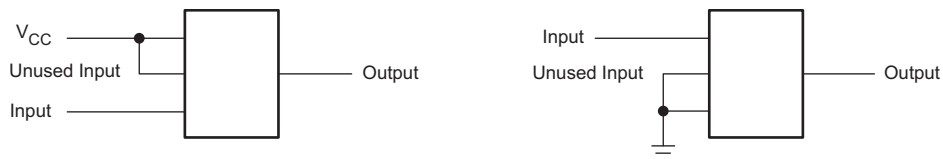

Figure 6. Layout Diagram

12 Device and Documentation Support

12.1 Documentation Support

12.1.1 Related Documentation

For related documentation see the following:

[Implications of Slow or Floating CMOS Inputs](#) (SCBA004)

12.2 Related Links

The table below lists quick access links. Categories include technical documents, support and community resources, tools and software, and quick access to sample or buy.

Table 2. Related Links

| PARTS | PRODUCT FOLDER | SAMPLE & BUY | TECHNICAL DOCUMENTS | TOOLS & SOFTWARE | SUPPORT & COMMUNITY |
|------------|----------------------------|----------------------------|----------------------------|----------------------------|----------------------------|
| SN54AHC125 | Click here | Click here | Click here | Click here | Click here |
| SN74AHC125 | Click here | Click here | Click here | Click here | Click here |

12.3 Receiving Notification of Documentation Updates

To receive notification of documentation updates, navigate to the device product folder on ti.com. In the upper right corner, click on *Alert me* to register and receive a weekly digest of any product information that has changed. For change details, review the revision history included in any revised document.

12.4 Community Resources

The following links connect to TI community resources. Linked contents are provided "AS IS" by the respective contributors. They do not constitute TI specifications and do not necessarily reflect TI's views; see TI's [Terms of Use](#).

TI E2E™ Online Community *TI's Engineer-to-Engineer (E2E) Community*. Created to foster collaboration among engineers. At e2e.ti.com, you can ask questions, share knowledge, explore ideas and help solve problems with fellow engineers.

Design Support *TI's Design Support* Quickly find helpful E2E forums along with design support tools and contact information for technical support.

12.5 Trademarks

E2E is a trademark of Texas Instruments.

All other trademarks are the property of their respective owners.

12.6 Electrostatic Discharge Caution



These devices have limited built-in ESD protection. The leads should be shorted together or the device placed in conductive foam during storage or handling to prevent electrostatic damage to the MOS gates.

12.7 Glossary

[SLYZ022](#) — *TI Glossary*.

This glossary lists and explains terms, acronyms, and definitions.

13 Mechanical, Packaging, and Orderable Information

The following pages include mechanical, packaging, and orderable information. This information is the most current data available for the designated devices. This data is subject to change without notice and revision of this document. For browser-based versions of this data sheet, refer to the left-hand navigation.

PACKAGING INFORMATION

| Orderable Device | Status (1) | Package Type | Package Drawing | Pins | Package Qty | Eco Plan (2) | Lead finish/ Ball material (6) | MSL Peak Temp (3) | Op Temp (°C) | Device Marking (4/5) | Samples |
|------------------|---------------|--------------|-----------------|------|-------------|---------------------|--------------------------------------|----------------------|--------------|--|-------------------------|
| 5962-9686801Q2A | ACTIVE | LCCC | FK | 20 | 1 | Non-RoHS & Green | SNPB | N / A for Pkg Type | -55 to 125 | 5962- 9686801Q2A SNJ54AHC 125FK | Samples |
| 5962-9686801QCA | ACTIVE | CDIP | J | 14 | 1 | Non-RoHS & Green | SNPB | N / A for Pkg Type | -55 to 125 | 5962-9686801QC A SNJ54AHC125J | Samples |
| 5962-9686801QDA | ACTIVE | CFP | W | 14 | 1 | Non-RoHS & Green | SNPB | N / A for Pkg Type | -55 to 125 | 5962-9686801QD A SNJ54AHC125W | Samples |
| SN74AHC125DBR | ACTIVE | SSOP | DB | 14 | 2000 | RoHS & Green | NIPDAU | Level-1-260C-UNLIM | -40 to 125 | HA125 | Samples |
| SN74AHC125DGVR | ACTIVE | TVSOP | DGV | 14 | 2000 | RoHS & Green | NIPDAU | Level-1-260C-UNLIM | -40 to 125 | HA125 | Samples |
| SN74AHC125DR | ACTIVE | SOIC | D | 14 | 2500 | RoHS & Green | NIPDAU | Level-1-260C-UNLIM | -40 to 125 | AHC125 | Samples |
| SN74AHC125DRG4 | ACTIVE | SOIC | D | 14 | 2500 | RoHS & Green | NIPDAU | Level-1-260C-UNLIM | -40 to 125 | AHC125 | Samples |
| SN74AHC125N | ACTIVE | PDIP | N | 14 | 25 | RoHS & Green | NIPDAU | N / A for Pkg Type | -40 to 125 | SN74AHC125N | Samples |
| SN74AHC125NE4 | ACTIVE | PDIP | N | 14 | 25 | RoHS & Green | NIPDAU | N / A for Pkg Type | -40 to 125 | SN74AHC125N | Samples |
| SN74AHC125NSR | ACTIVE | SO | NS | 14 | 2000 | RoHS & Green | NIPDAU | Level-1-260C-UNLIM | -40 to 125 | AHC125 | Samples |
| SN74AHC125PWR | ACTIVE | TSSOP | PW | 14 | 2000 | RoHS & Green | NIPDAU | Level-1-260C-UNLIM | -40 to 125 | HA125 | Samples |
| SN74AHC125PWRE4 | ACTIVE | TSSOP | PW | 14 | 2000 | RoHS & Green | NIPDAU | Level-1-260C-UNLIM | -40 to 125 | HA125 | Samples |
| SN74AHC125PWRG4 | ACTIVE | TSSOP | PW | 14 | 2000 | RoHS & Green | NIPDAU | Level-1-260C-UNLIM | -40 to 125 | HA125 | Samples |
| SN74AHC125RGYR | ACTIVE | VQFN | RGY | 14 | 3000 | RoHS & Green | NIPDAU | Level-2-260C-1 YEAR | -40 to 125 | HA125 | Samples |
| SNJ54AHC125FK | ACTIVE | LCCC | FK | 20 | 1 | Non-RoHS & Green | SNPB | N / A for Pkg Type | -55 to 125 | 5962- 9686801Q2A SNJ54AHC 125FK | Samples |
| SNJ54AHC125J | ACTIVE | CDIP | J | 14 | 1 | Non-RoHS & Green | SNPB | N / A for Pkg Type | -55 to 125 | 5962-9686801QC A | Samples |

| Orderable Device | Status (1) | Package Type | Package Drawing | Pins | Package Qty | Eco Plan (2) | Lead finish/ Ball material (6) | MSL Peak Temp (3) | Op Temp (°C) | Device Marking (4/5) | Samples |
|------------------|---------------|--------------|-----------------|------|-------------|------------------|--------------------------------------|----------------------|--------------|---|-------------------------|
| SNJ54AHC125W | ACTIVE | CFP | W | 14 | 1 | Non-RoHS & Green | SNPB | N / A for Pkg Type | -55 to 125 | SNJ54AHC125J 5962-9686801QD A SNJ54AHC125W | Samples |

(1) The marketing status values are defined as follows:

ACTIVE: Product device recommended for new designs.

LIFEBUY: TI has announced that the device will be discontinued, and a lifetime-buy period is in effect.

NRND: Not recommended for new designs. Device is in production to support existing customers, but TI does not recommend using this part in a new design.

PREVIEW: Device has been announced but is not in production. Samples may or may not be available.

OBSELETE: TI has discontinued the production of the device.

(2) **RoHS:** TI defines "RoHS" to mean semiconductor products that are compliant with the current EU RoHS requirements for all 10 RoHS substances, including the requirement that RoHS substance do not exceed 0.1% by weight in homogeneous materials. Where designed to be soldered at high temperatures, "RoHS" products are suitable for use in specified lead-free processes. TI may reference these types of products as "Pb-Free".

RoHS Exempt: TI defines "RoHS Exempt" to mean products that contain lead but are compliant with EU RoHS pursuant to a specific EU RoHS exemption.

Green: TI defines "Green" to mean the content of Chlorine (Cl) and Bromine (Br) based flame retardants meet JS709B low halogen requirements of <=1000ppm threshold. Antimony trioxide based flame retardants must also meet the <=1000ppm threshold requirement.

(3) MSL, Peak Temp. - The Moisture Sensitivity Level rating according to the JEDEC industry standard classifications, and peak solder temperature.

(4) There may be additional marking, which relates to the logo, the lot trace code information, or the environmental category on the device.

(5) Multiple Device Markings will be inside parentheses. Only one Device Marking contained in parentheses and separated by a "-" will appear on a device. If a line is indented then it is a continuation of the previous line and the two combined represent the entire Device Marking for that device.

(6) Lead finish/Ball material - Orderable Devices may have multiple material finish options. Finish options are separated by a vertical ruled line. Lead finish/Ball material values may wrap to two lines if the finish value exceeds the maximum column width.

Important Information and Disclaimer:The information provided on this page represents TI's knowledge and belief as of the date that it is provided. TI bases its knowledge and belief on information provided by third parties, and makes no representation or warranty as to the accuracy of such information. Efforts are underway to better integrate information from third parties. TI has taken and continues to take reasonable steps to provide representative and accurate information but may not have conducted destructive testing or chemical analysis on incoming materials and chemicals. TI and TI suppliers consider certain information to be proprietary, and thus CAS numbers and other limited information may not be available for release.

In no event shall TI's liability arising out of such information exceed the total purchase price of the TI part(s) at issue in this document sold by TI to Customer on an annual basis.

OTHER QUALIFIED VERSIONS OF SN54AHC125, SN74AHC125 :

- Catalog : [SN74AHC125](#)
- Automotive : [SN74AHC125-Q1](#), [SN74AHC125-Q1](#)
- Enhanced Product : [SN74AHC125-EP](#), [SN74AHC125-EP](#)
- Military : [SN54AHC125](#)

NOTE: Qualified Version Definitions:

- Catalog - TI's standard catalog product
- Automotive - Q100 devices qualified for high-reliability automotive applications targeting zero defects
- Enhanced Product - Supports Defense, Aerospace and Medical Applications
- Military - QML certified for Military and Defense Applications

TAPE AND REEL INFORMATION

QUADRANT ASSIGNMENTS FOR PIN 1 ORIENTATION IN TAPE

*All dimensions are nominal

| Device | Package Type | Package Drawing | Pins | SPQ | Reel Diameter (mm) | Reel Width W1 (mm) | A0 (mm) | B0 (mm) | K0 (mm) | P1 (mm) | W (mm) | Pin1 Quadrant |
|----------------|--------------|-----------------|------|------|--------------------|--------------------|---------|---------|---------|---------|--------|---------------|
| SN74AHC125DBR | SSOP | DB | 14 | 2000 | 330.0 | 16.4 | 8.35 | 6.6 | 2.4 | 12.0 | 16.0 | Q1 |
| SN74AHC125DGVR | TVSOP | DGV | 14 | 2000 | 330.0 | 12.4 | 6.8 | 4.0 | 1.6 | 8.0 | 12.0 | Q1 |
| SN74AHC125DR | SOIC | D | 14 | 2500 | 330.0 | 16.4 | 6.5 | 9.0 | 2.1 | 8.0 | 16.0 | Q1 |
| SN74AHC125NSR | SO | NS | 14 | 2000 | 330.0 | 16.4 | 8.2 | 10.5 | 2.5 | 12.0 | 16.0 | Q1 |
| SN74AHC125PWR | TSSOP | PW | 14 | 2000 | 330.0 | 12.4 | 6.9 | 5.6 | 1.6 | 8.0 | 12.0 | Q1 |
| SN74AHC125RGYR | VQFN | RGY | 14 | 3000 | 330.0 | 12.4 | 3.75 | 3.75 | 1.15 | 8.0 | 12.0 | Q1 |

TAPE AND REEL BOX DIMENSIONS

*All dimensions are nominal

| Device | Package Type | Package Drawing | Pins | SPQ | Length (mm) | Width (mm) | Height (mm) |
|----------------|--------------|-----------------|------|------|-------------|------------|-------------|
| SN74AHC125DBR | SSOP | DB | 14 | 2000 | 356.0 | 356.0 | 35.0 |
| SN74AHC125DGVR | TVSOP | DGV | 14 | 2000 | 356.0 | 356.0 | 35.0 |
| SN74AHC125DR | SOIC | D | 14 | 2500 | 340.5 | 336.1 | 32.0 |
| SN74AHC125NSR | SO | NS | 14 | 2000 | 356.0 | 356.0 | 35.0 |
| SN74AHC125PWR | TSSOP | PW | 14 | 2000 | 356.0 | 356.0 | 35.0 |
| SN74AHC125RGYR | VQFN | RGY | 14 | 3000 | 356.0 | 356.0 | 35.0 |

TUBE

*All dimensions are nominal

| Device | Package Name | Package Type | Pins | SPQ | L (mm) | W (mm) | T (μm) | B (mm) |
|-----------------|--------------|--------------|------|-----|--------|--------|--------|--------|
| 5962-9686801Q2A | FK | LCCC | 20 | 1 | 506.98 | 12.06 | 2030 | NA |
| 5962-9686801QDA | W | CFP | 14 | 1 | 506.98 | 26.16 | 6220 | NA |
| SN74AHC125N | N | PDIP | 14 | 25 | 506 | 13.97 | 11230 | 4.32 |
| SN74AHC125N | N | PDIP | 14 | 25 | 506 | 13.97 | 11230 | 4.32 |
| SN74AHC125NE4 | N | PDIP | 14 | 25 | 506 | 13.97 | 11230 | 4.32 |
| SN74AHC125NE4 | N | PDIP | 14 | 25 | 506 | 13.97 | 11230 | 4.32 |
| SNJ54AHC125FK | FK | LCCC | 20 | 1 | 506.98 | 12.06 | 2030 | NA |
| SNJ54AHC125W | W | CFP | 14 | 1 | 506.98 | 26.16 | 6220 | NA |

RGY (S-PVQFN-N14)

PLASTIC QUAD FLATPACK NO-LEAD



- NOTES:
- A. All linear dimensions are in millimeters. Dimensioning and tolerancing per ASME Y14.5M-1994.
 - B. This drawing is subject to change without notice.
 - C. QFN (Quad Flatpack No-Lead) package configuration.
 - D. The package thermal pad must be soldered to the board for thermal and mechanical performance.
 - E. See the additional figure in the Product Data Sheet for details regarding the exposed thermal pad features and dimensions.
 -  Pin 1 identifiers are located on both top and bottom of the package and within the zone indicated. The Pin 1 identifiers are either a molded, marked, or metal feature.
 - G. Package complies to JEDEC MO-241 variation BA.

RGY (S-PVQFN-N14)

PLASTIC QUAD FLATPACK NO-LEAD

THERMAL INFORMATION

This package incorporates an exposed thermal pad that is designed to be attached directly to an external heatsink. The thermal pad must be soldered directly to the printed circuit board (PCB). After soldering, the PCB can be used as a heatsink. In addition, through the use of thermal vias, the thermal pad can be attached directly to the appropriate copper plane shown in the electrical schematic for the device, or alternatively, can be attached to a special heatsink structure designed into the PCB. This design optimizes the heat transfer from the integrated circuit (IC).

For information on the Quad Flatpack No-Lead (QFN) package and its advantages, refer to Application Report, QFN/SON PCB Attachment, Texas Instruments Literature No. SLUA271. This document is available at www.ti.com.

The exposed thermal pad dimensions for this package are shown in the following illustration.



Bottom View

Exposed Thermal Pad Dimensions

4206353-2/P 03/14

NOTE: All linear dimensions are in millimeters

RGY (S-PVQFN-N14)

PLASTIC QUAD FLATPACK NO-LEAD



4208122-2/P 03/14

- NOTES:
- All linear dimensions are in millimeters.
 - This drawing is subject to change without notice.
 - Publication IPC-7351 is recommended for alternate designs.
 - This package is designed to be soldered to a thermal pad on the board. Refer to Application Note, Quad Flat-Pack QFN/SON PCB Attachment, Texas Instruments Literature No. SLUA271, and also the Product Data Sheets for specific thermal information, via requirements, and recommended board layout. These documents are available at www.ti.com <<http://www.ti.com>>.
 - Laser cutting apertures with trapezoidal walls and also rounding corners will offer better paste release. Customers should contact their board assembly site for stencil design recommendations. Refer to IPC 7525 for stencil design considerations.
 - Customers should contact their board fabrication site for minimum solder mask web tolerances between signal pads.

MECHANICAL DATA

NS (R-PDSO-G**)

PLASTIC SMALL-OUTLINE PACKAGE

14-PINS SHOWN



- NOTES:
- A. All linear dimensions are in millimeters.
 - B. This drawing is subject to change without notice.
 - C. Body dimensions do not include mold flash or protrusion, not to exceed 0,15.

W (R-GDFP-F14)

CERAMIC DUAL FLATPACK



- NOTES:
- A. All linear dimensions are in inches (millimeters).
 - B. This drawing is subject to change without notice.
 - C. This package can be hermetically sealed with a ceramic lid using glass frit.
 - D. Index point is provided on cap for terminal identification only.
 - E. Falls within MIL STD 1835 GDFP1-F14

DGV (R-PDSO-G**)

PLASTIC SMALL-OUTLINE

24 PINS SHOWN



- NOTES: A. All linear dimensions are in millimeters.
 B. This drawing is subject to change without notice.
 C. Body dimensions do not include mold flash or protrusion, not to exceed 0,15 per side.
 D. Falls within JEDEC: 24/48 Pins – MO-153
 14/16/20/56 Pins – MO-194

GENERIC PACKAGE VIEW

FK 20

LCCC - 2.03 mm max height

8.89 x 8.89, 1.27 mm pitch

LEADLESS CERAMIC CHIP CARRIER

This image is a representation of the package family, actual package may vary.
Refer to the product data sheet for package details.



4229370VA\

J 14

GENERIC PACKAGE VIEW
CDIP - 5.08 mm max height
CERAMIC DUAL IN LINE PACKAGE



Images above are just a representation of the package family, actual package may vary.
Refer to the product data sheet for package details.

4040083-5/G

J0014A



PACKAGE OUTLINE

CDIP - 5.08 mm max height

CERAMIC DUAL IN LINE PACKAGE



4214771/A 05/2017

NOTES:

1. All controlling linear dimensions are in inches. Dimensions in brackets are in millimeters. Any dimension in brackets or parenthesis are for reference only. Dimensioning and tolerancing per ASME Y14.5M.
2. This drawing is subject to change without notice.
3. This package is hermetically sealed with a ceramic lid using glass frit.
4. Index point is provided on cap for terminal identification only and on press ceramic glass frit seal only.
5. Falls within MIL-STD-1835 and GDIP1-T14.

EXAMPLE BOARD LAYOUT

J0014A

CDIP - 5.08 mm max height

CERAMIC DUAL IN LINE PACKAGE



LAND PATTERN EXAMPLE
NON-SOLDER MASK DEFINED
SCALE: 5X



4214771/A 05/2017

D (R-PDSO-G14)

PLASTIC SMALL OUTLINE



- NOTES:
- A. All linear dimensions are in inches (millimeters).
 - B. This drawing is subject to change without notice.
 - Body length does not include mold flash, protrusions, or gate burrs. Mold flash, protrusions, or gate burrs shall not exceed 0.006 (0,15) each side.
 - Body width does not include interlead flash. Interlead flash shall not exceed 0.017 (0,43) each side.
 - E. Reference JEDEC MS-012 variation AB.

D (R-PDSO-G14)

PLASTIC SMALL OUTLINE



- NOTES:
- A. All linear dimensions are in millimeters.
 - B. This drawing is subject to change without notice.
 - C. Publication IPC-7351 is recommended for alternate designs.
 - D. Laser cutting apertures with trapezoidal walls and also rounding corners will offer better paste release. Customers should contact their board assembly site for stencil design recommendations. Refer to IPC-7525 for other stencil recommendations.
 - E. Customers should contact their board fabrication site for solder mask tolerances between and around signal pads.

MECHANICAL DATA

PW (R-PDSO-G14)

PLASTIC SMALL OUTLINE



4040064-3/G 02/11

- NOTES:
- A. All linear dimensions are in millimeters. Dimensioning and tolerancing per ASME Y14.5M-1994.
 - B. This drawing is subject to change without notice.
 -  Body length does not include mold flash, protrusions, or gate burrs. Mold flash, protrusions, or gate burrs shall not exceed 0,15 each side.
 -  Body width does not include interlead flash. Interlead flash shall not exceed 0,25 each side.
 - E. Falls within JEDEC MO-153

N (R-PDIP-T**)

PLASTIC DUAL-IN-LINE PACKAGE

16 PINS SHOWN



- NOTES:
- A. All linear dimensions are in inches (millimeters).
 - B. This drawing is subject to change without notice.
 - Falls within JEDEC MS-001, except 18 and 20 pin minimum body length (Dim A).
 - The 20 pin end lead shoulder width is a vendor option, either half or full width.

DB (R-PDSO-G**)

PLASTIC SMALL-OUTLINE

28 PINS SHOWN



- NOTES: A. All linear dimensions are in millimeters.
 B. This drawing is subject to change without notice.
 C. Body dimensions do not include mold flash or protrusion not to exceed 0,15.
 D. Falls within JEDEC MO-150

IMPORTANT NOTICE AND DISCLAIMER

TI PROVIDES TECHNICAL AND RELIABILITY DATA (INCLUDING DATA SHEETS), DESIGN RESOURCES (INCLUDING REFERENCE DESIGNS), APPLICATION OR OTHER DESIGN ADVICE, WEB TOOLS, SAFETY INFORMATION, AND OTHER RESOURCES "AS IS" AND WITH ALL FAULTS, AND DISCLAIMS ALL WARRANTIES, EXPRESS AND IMPLIED, INCLUDING WITHOUT LIMITATION ANY IMPLIED WARRANTIES OF MERCHANTABILITY, FITNESS FOR A PARTICULAR PURPOSE OR NON-INFRINGEMENT OF THIRD PARTY INTELLECTUAL PROPERTY RIGHTS.

These resources are intended for skilled developers designing with TI products. You are solely responsible for (1) selecting the appropriate TI products for your application, (2) designing, validating and testing your application, and (3) ensuring your application meets applicable standards, and any other safety, security, regulatory or other requirements.

These resources are subject to change without notice. TI grants you permission to use these resources only for development of an application that uses the TI products described in the resource. Other reproduction and display of these resources is prohibited. No license is granted to any other TI intellectual property right or to any third party intellectual property right. TI disclaims responsibility for, and you will fully indemnify TI and its representatives against, any claims, damages, costs, losses, and liabilities arising out of your use of these resources.

TI's products are provided subject to [TI's Terms of Sale](#) or other applicable terms available either on [ti.com](https://www.ti.com) or provided in conjunction with such TI products. TI's provision of these resources does not expand or otherwise alter TI's applicable warranties or warranty disclaimers for TI products.

TI objects to and rejects any additional or different terms you may have proposed.

Mailing Address: Texas Instruments, Post Office Box 655303, Dallas, Texas 75265
Copyright © 2023, Texas Instruments Incorporated