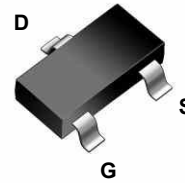
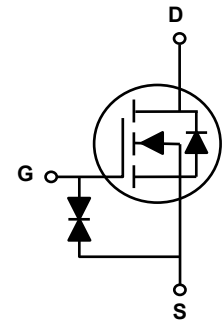


### Main Product Characteristics

$V_{(BR)DSS}$	20V
$R_{DS(ON)}$	300mΩ
$I_D$	800mA



SOT-523



Schematic Diagram

### Features and Benefits

- Advanced MOSFET process technology
- Ideal for high efficiency switched mode power supplies
- Low on-resistance with low gate charge
- Fast switching and reverse body recovery
- ESD level: 2KV



### Description

The SSF2320Y utilizes the latest techniques to achieve high cell density and low on-resistance. These features make this device extremely efficient and reliable for use in high efficiency switch mode power supplies and a wide variety of other applications.

### Absolute Maximum Ratings ( $T_C=25^{\circ}C$ unless otherwise specified)

Parameter	Symbol	Max.	Unit
Drain-Source Voltage	$V_{DS}$	20	V
Gate-Source Voltage	$V_{GS}$	±8	V
Drain Current-Continuous ( $T_C=25^{\circ}C$ )	$I_D$	800	mA
Drain Current-Continuous ( $T_C=100^{\circ}C$ )		510	
Drain Current-Pulsed <sup>1</sup>	$I_{DM}$	3.2	A
Power Dissipation ( $T_C=25^{\circ}C$ )	$P_D$	312	mW
Power Dissipation - Derate above 25°C		2.5	mW/°C
Thermal Resistance, Junction-to-Ambient	$R_{\theta JA}$	400	°C/W
Operating Junction Temperature Range	$T_J$	-55 To +150	°C
Storage Temperature Range	$T_{STG}$	-55 To +150	°C

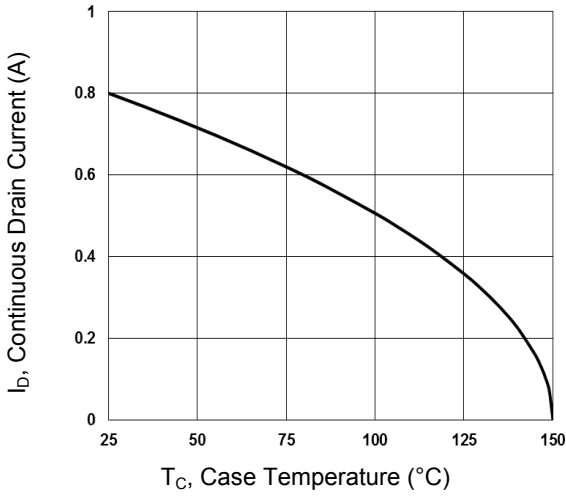
**Electrical Characteristics** ( $T_J=25^\circ\text{C}$  unless otherwise specified)

Parameter	Symbol	Conditions	Min.	Typ.	Max.	Unit
<b>On / Off Characteristics</b>						
Drain-Source Breakdown Voltage	$BV_{DSS}$	$V_{GS}=0V, I_D=250\mu A$	20	-	-	V
$BV_{DSS}$ Temperature Coefficient	$\frac{\Delta BV_{DSS}}{\Delta T_J}$	Reference to $25^\circ\text{C}$ , $I_D=1\text{mA}$	-	-0.01	-	$V/^\circ\text{C}$
Drain-Source Leakage Current	$I_{DSS}$	$V_{DS}=20V, V_{GS}=0V,$ $T_J=25^\circ\text{C}$	-	-	1	$\mu A$
		$V_{DS}=16V, V_{GS}=0V,$ $T_J=125^\circ\text{C}$	-	-	10	$\mu A$
Gate-Source Leakage Current	$I_{GSS}$	$V_{GS}=\pm 6V, V_{DS}=0V$	-	-	$\pm 20$	$\mu A$
Static Drain-Source On-Resistance	$R_{DS(ON)}$	$V_{GS}=4.5V, I_D=0.5A$	-	200	300	m $\Omega$
		$V_{GS}=2.5V, I_D=0.4A$	-	235	400	
		$V_{GS}=1.8V, I_D=0.2A$	-	295	550	
		$V_{GS}=1.5V, I_D=0.1A$	-	365	800	
		$V_{GS}=1.2V, I_D=0.1A$	-	600	1500	
Gate Threshold Voltage	$V_{GS(th)}$	$V_{GS}=V_{DS}, I_D=250\mu A$	0.3	0.6	1	V
$V_{GS(th)}$ Temperature Coefficient	$\Delta V_{GS(th)}$		-	3	-	$\text{mV}/^\circ\text{C}$
<b>Dynamic and Switching Characteristics</b>						
Total Gate Charge <sup>2,3</sup>	$Q_g$	$V_{DS}=10V, I_D=0.5A$ $V_{GS}=4.5V$	-	1	2	nC
Gate-Source Charge <sup>2,3</sup>	$Q_{gs}$		-	0.26	0.5	
Gate-Drain Charge <sup>2,3</sup>	$Q_{gd}$		-	0.2	0.4	
Turn-On Delay Time <sup>2,3</sup>	$t_{d(on)}$	$V_{DD}=10V, R_G=10\Omega$ $V_{GS}=4.5V, I_D=0.5A$	-	5	10	nS
Rise Time <sup>2,3</sup>	$t_r$		-	3.5	7	
Turn-Off Delay Time <sup>2,3</sup>	$t_{d(off)}$		-	14	28	
Fall Time <sup>2,3</sup>	$t_f$		-	6	12	
Input Capacitance	$C_{iss}$	$V_{DS}=10V, V_{GS}=0V,$ $F=1\text{MHz}$	-	38.2	75	pF
Output Capacitance	$C_{oss}$		-	14.4	28	
Reverse Transfer Capacitance	$C_{rss}$		-	6	12	
<b>Drain-Source Diode Characteristics and Maximum Ratings</b>						
Continuous Source Current	$I_S$	$V_G=V_D=0V, \text{Force Current}$	-	-	0.8	A
Pulsed Source Current	$I_{SM}$		-	-	1.6	A
Diode Forward Voltage	$V_{SD}$	$V_{GS}=0V, I_S=0.2A,$ $T_J=25^\circ\text{C}$	-	-	1	V

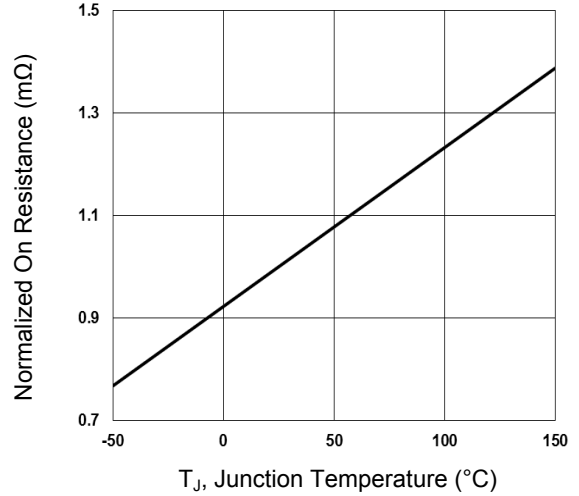
Note:

1. Repetitive Rating: Pulsed width limited by maximum junction temperature.
2. The data tested by pulsed, pulse width  $\leq 300\mu\text{s}$ , duty cycle  $\leq 2\%$ .
3. Essentially independent of operating temperature.

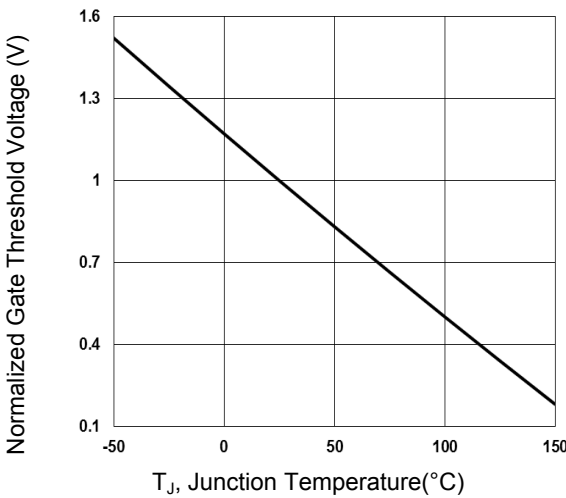
**Typical Electrical and Thermal Characteristic Curves**



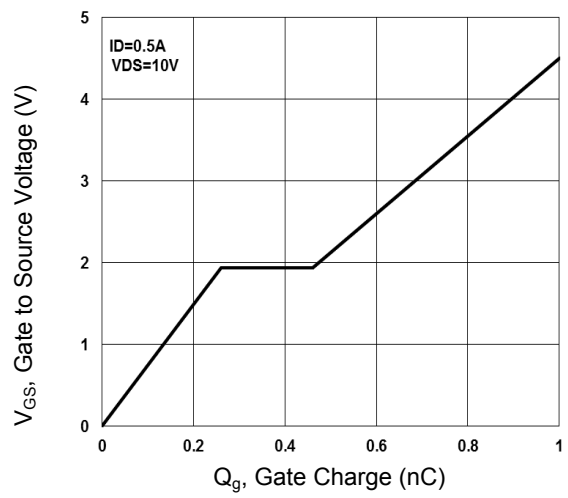
**Figure 1. Continuous Drain Current vs.  $T_C$**



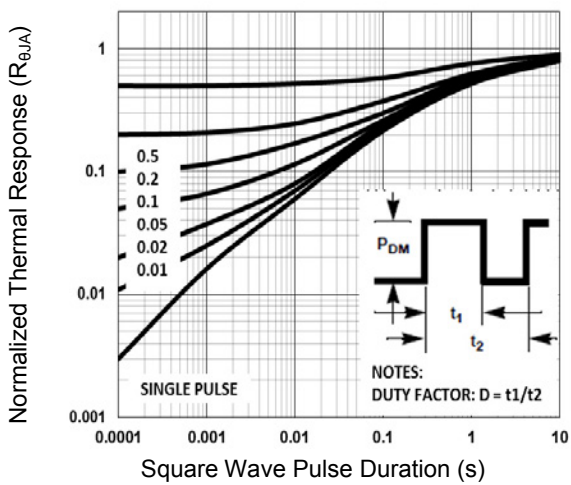
**Figure 2. Normalized  $R_{DS(ON)}$  vs.  $T_J$**



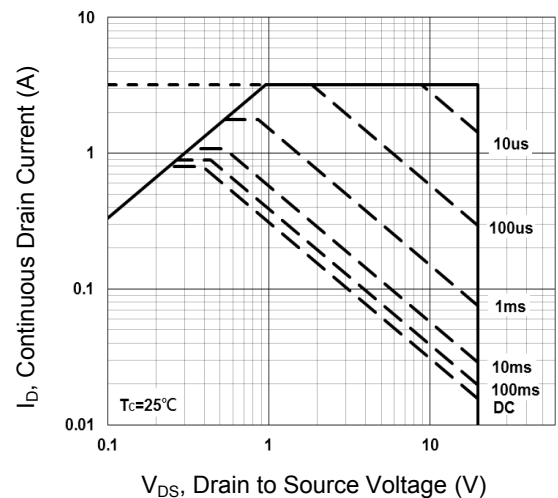
**Figure 3. Normalized  $V_{th}$  vs  $T_J$**



**Figure 4. Gate Charge Waveform**

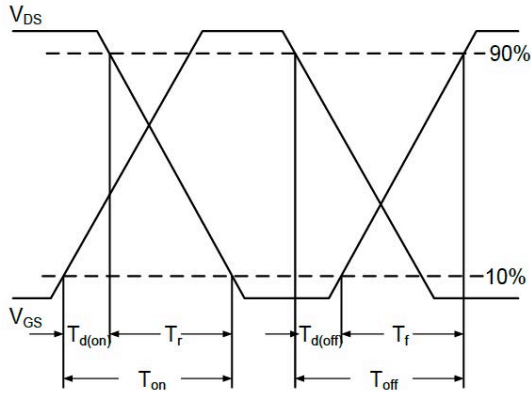


**Figure 5. Normalized Transient Impedance**

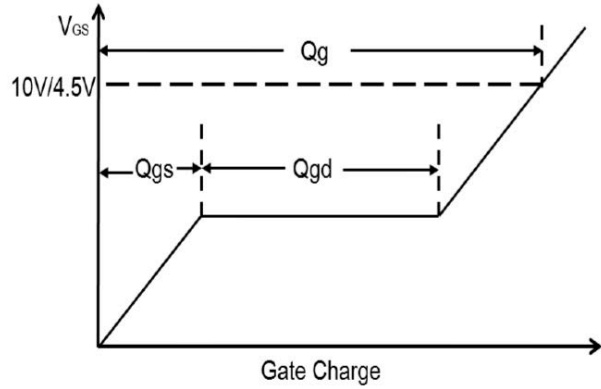


**Figure 6. Maximum Safe Operation Area**

**Typical Electrical and Thermal Characteristic Curves**

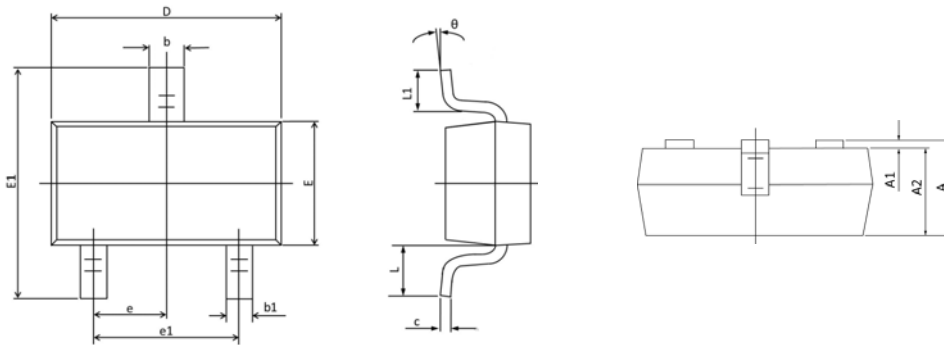


**Figure 7. Switching Time Waveform**



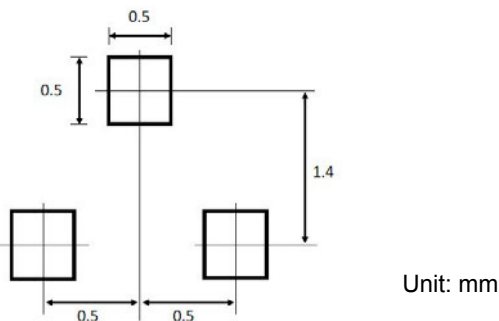
**Figure 8. Gate Charge Waveform**

**Package Outline Dimensions (SOT-523)**



Symbol	Dimensions in Millimeters		Dimensions in Inches	
	Min	Max	Min	Max
A	0.700	0.900	0.028	0.035
A1	0.000	0.100	0.000	0.004
A2	0.700	0.800	0.028	0.031
b	0.250	0.350	0.010	0.014
b1	0.150	0.250	0.006	0.010
c	0.100	0.200	0.004	0.008
D	1.500	1.750	0.059	0.069
E	0.700	0.900	0.028	0.035
E1	1.400	1.750	0.055	0.069
e	0.500 TYP		0.020 TYP	
e1	0.900	1.100	0.035	0.043
L	0.300	0.460	0.012	0.018
L1	0.260	0.460	0.010	0.018
θ	0°	8°	0°	8°

**Recommended Pad Layout**



**Order Information**

Device	Package	Marking	Carrier	Quantity
SSF2320Y	SOT-523	B	Tape & Reel	3,000 pcs / Reel