

# BQ25616/616J Standalone 1-Cell 3.0-A Buck Battery Charger with Power Path and 1.2-A Boost Operation

## 1 Features

- High-efficiency, 1.5-MHz, synchronous switch-mode buck charger
  - 92% charge efficiency at 2-A from 5-V input
  - $\pm 0.5\%$  charge voltage regulation
  - Adjustable charge voltage from VSET pin supports 4.1-V, 4.2-V, and 4.35-V with  $\pm 0.4\%$  regulation accuracy
  - $\pm 6\%$  charge current regulation
  - $\pm 7.5\%$  input current regulation
  - Supports JEITA (BQ25616J) or Hot/Cold (BQ25616) temperature sensing profile
  - 20-hr charging safety timer
- Support USB On-The-Go (OTG)
  - 5-V boost converter with up to 1.2-A output
  - 92% boost efficiency at 1-A output
  - Accurate constant current (CC) limit
  - Soft-start up to 500- $\mu$ F capacitive load
  - PFM mode for light load operation
- Single input supporting USB input, high-voltage adapter, or wireless power
  - Support 4-V to 13.5-V input voltage range with 22-V absolute max input rating
  - 130-ns fast turn-off with optional external OVPFET standing input voltage up to 30 V
  - Programmable input current limit (IINDPM) with ILIM pin
  - VINDPM threshold automatically tracks battery voltage for maximum power
  - Auto detect USB SDP, CDP, DCP and non-standard adaptors
- Narrow VDC (NVDC) power path management
  - System instant-on with no battery or deeply discharged battery
- Low  $R_{DS(ON)}$  19.5-m $\Omega$  BATFET to minimize charging loss and extend battery run time
- 9.5- $\mu$ A low battery leakage current with system standby
- High integration includes all MOSFETs, current sensing and loop compensation

## 2 Applications

- [Electronic Point of Sale \(EPOS\)](#)
- [Wireless speaker](#)
- [Industrial, medical, portable electronics](#)

## 3 Description

The BQ25616/616J is a highly integrated 3-A switch-mode battery charge management and system power path management device for single cell Li-Ion and Li-polymer batteries. The solution is highly integrated with input reverse-blocking FET (RBFET, Q1), high-side switching FET (HSFET, Q2), low-side switching FET (LSFET, Q3), and battery FET (BATFET, Q4) between system and battery. The low impedance power path optimizes switch-mode operation efficiency, reduces battery charging time and extends battery run time during discharging phase.

The BQ25616/616J is a highly integrated 3-A switch-mode battery charge management and system Power Path management device for Li-ion and Li-polymer batteries. It features fast charging with high input voltage support for a wide range of applications including speakers, industrial, and medical portable devices. Its low impedance power path optimizes switch-mode operation efficiency, reduces battery charging time, and extends battery run time during discharging phase. Its input voltage and current regulation deliver maximum charging power to the battery.

### Device Information<sup>(1)</sup>

PART NUMBER	PACKAGE	BODY SIZE (NOM)
BQ25616/616J	WQFN (24)	4.00 mm x 4.00 mm

(1) For all available packages, see the orderable addendum at the end of the data sheet.

### Simplified Application

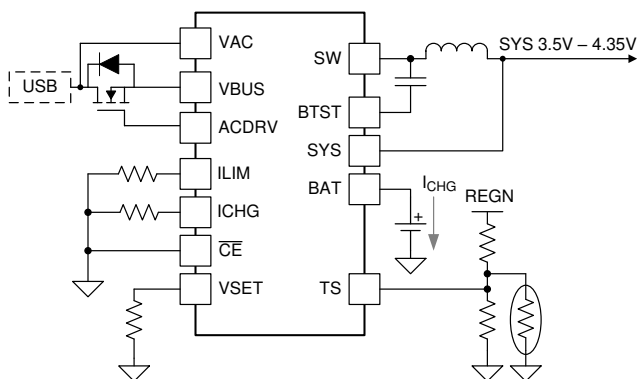

## Table of Contents

<b>1 Features</b> .....	<b>1</b>	9.3 Feature Description .....	<b>16</b>
<b>2 Applications</b> .....	<b>1</b>	9.4 Device Functional Modes .....	<b>27</b>
<b>3 Description</b> .....	<b>1</b>	<b>10 Application and Implementation</b> .....	<b>28</b>
<b>4 Revision History</b> .....	<b>2</b>	10.1 Application Information .....	<b>28</b>
<b>5 Description (continued)</b> .....	<b>3</b>	10.2 Typical Applications .....	<b>28</b>
<b>6 Device Comparison Table</b> .....	<b>4</b>	<b>11 Power Supply Recommendations</b> .....	<b>37</b>
<b>7 Pin Configuration and Functions</b> .....	<b>5</b>	<b>12 Layout</b> .....	<b>37</b>
<b>8 Specifications</b> .....	<b>7</b>	12.1 Layout Guidelines .....	<b>37</b>
8.1 Absolute Maximum Ratings .....	<b>7</b>	12.2 Layout Example .....	<b>37</b>
8.2 ESD Ratings .....	<b>7</b>	<b>13 Device and Documentation Support</b> .....	<b>39</b>
8.3 Recommended Operating Conditions .....	<b>7</b>	13.1 Device Support .....	<b>39</b>
8.4 Thermal Information .....	<b>7</b>	13.2 Documentation Support .....	<b>39</b>
8.5 Electrical Characteristics .....	<b>8</b>	13.3 Receiving Notification of Documentation Updates .....	<b>39</b>
8.6 Timing Requirements .....	<b>12</b>	13.4 Support Resources .....	<b>39</b>
8.7 Typical Characteristics .....	<b>13</b>	13.5 Trademarks .....	<b>39</b>
<b>9 Detailed Description</b> .....	<b>15</b>	13.6 Electrostatic Discharge Caution .....	<b>39</b>
9.1 Overview .....	<b>15</b>	13.7 Glossary .....	<b>39</b>
9.2 Functional Block Diagram .....	<b>15</b>	<b>14 Mechanical, Packaging, and Orderable Information</b> .....	<b>40</b>

## 4 Revision History

DATE	REVISION	NOTES
January 2020	*	Initial release.

## 5 Description (continued)

The solution is highly integrated with input reverse-blocking FET (RBFET, Q1), high-side switching FET (HSFET, Q2), low-side switching FET (LSFET, Q3), and battery FET (BATFET, Q4) between system and battery. It also integrates the bootstrap diode for the high-side gate drive for simplified system design. The hardware setting and status report provides easy configuration to set up the charging solution.

The device supports a wide range of input sources, including standard USB host port, USB charging port, USB compliant high voltage adapter and wireless power. It is compliant with USB 2.0 and USB 3.0 power spec with input current and voltage regulation. The device sets default input current limit based on the built-in USB detection through D+/D- pins. When the device built-in USB interface identifies the input adaptor is unknown, the device's input current limit is determined by the ILIM pin setting resistor value.

The device integrates the buck charger and boost regulator into one solution with single inductor. It meets USB On-The-Go (OTG) operation power rating specification by supplying 5-V with constant current limit up to 1.2-A.

The Power Path management regulates the system slightly above battery voltage but does not drop below 3.5-V minimum system voltage with adapter applied. With this feature, the system maintains operation even when the battery is completely depleted or removed. When the input current limit or voltage limit is reached, the Power Path management automatically reduces the charge current. As the system load continues to increase, the battery starts to discharge the battery until the system power requirement is met. This supplement mode prevents overloading the input source.

The device initiates and completes a charging cycle without software control. It senses the battery voltage and charges the battery in three phases: pre-conditioning, constant current and constant voltage. At the end of the charging cycle, the charger automatically terminates when the charge current is below a preset limit and the battery voltage is higher than the recharge threshold. If the fully charged battery falls below the recharge threshold, the charger automatically starts another charging cycle.

The charger provides various safety features for battery charging and system operations, including battery negative temperature coefficient thermistor monitoring, charging safety timer and overvoltage and over-current protections. Thermal regulation reduces charge current when the junction temperature exceeds 110°C. The STAT output reports the charging status and any fault conditions.

## 6 Device Comparison Table

	<b>BQ25606</b>	<b>BQ25616</b>	<b>BQ25616J</b>
Quiescent battery current (BAT, SYS, SW)	58 $\mu$ A	9.5 $\mu$ A	9.5 $\mu$ A
VBUS OVP Reaction-time	200 ns	130 ns	130 ns
Input voltage regulation accuracy	$\pm$ 3%	$\pm$ 2%	$\pm$ 2%
TS profile	JEITA	Hot/Cold	JEITA
Charge safety timer accuracy	10 hr	20 hr	20 hr
Deglintch time for charge termination	250 ms	50 ms	50 ms
Battery voltage regulation	$\pm$ 0.5%	$\pm$ 0.4%	$\pm$ 0.4%
ACDRV	No	Yes	Yes

## 7 Pin Configuration and Functions

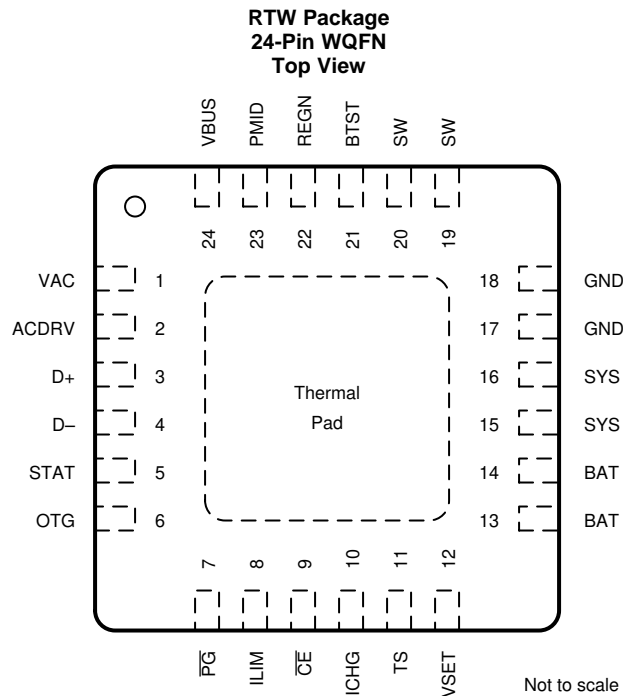

### Pin Functions

PIN		TYPE <sup>(1)</sup>	DESCRIPTION
NAME	NO.		
ACDRV	2	AO	Charge pump output to drive external N-channel MOSFET (ACFET). It provides 6V voltage above VBUS as gate drive to turn on ACFET when VAC voltage is below ACOV threshold (14.2-V) and above UVLO. Leave ACDRV floating if external OVP is not being used.
BAT	13	P	Battery connection point to the positive terminal of the battery pack. The internal current sensing resistor is connected between SYS and BAT. Connect a 10 $\mu\text{F}$ <sup>(2)</sup> closely to the BAT pin.
	14		
BTST	21	P	PWM high side driver positive supply. Internally, the BTST is connected to the cathode of the boot-strap diode. Connect the 0.047- $\mu\text{F}$ bootstrap capacitor <sup>(2)</sup> from SW to BTST.
$\overline{\text{CE}}$	9	DI	Charge enable pin. When this pin is driven LOW, battery charging is enabled.
D+	3	AIO	Positive line of the USB data line pair. D+/D– based USB host/charging port detection. The detection includes data contact detection (DCD), primary and secondary detection in BC1.2 and nonstandard adaptors
D–	4	AIO	Negative line of the USB data line pair. D+/D– based USB host/charging port detection. The detection includes data contact detection (DCD), primary and secondary detection in BC1.2 and nonstandard adaptors
GND	17	P	Power ground and signal ground
	18		
ICHG	10	AI	ICHG pin sets the charge current limit. A resistor is connected from ICHG pin to ground to set charge current limit as $\text{ICHG} = K_{\text{ICHG}}/R_{\text{ICHG}}$ . The acceptable range for charge current is 300 mA – 3000 mA.
ILIM	8	AI	ILIM sets the input current limit when the input adapter is detected as unknown. Otherwise, the input current limit is set by D+/D– detection outcome. A resistor is connected from ILIM pin to ground to set the input current limit as $\text{IINDPM} = K_{\text{ILIM}}/R_{\text{ILIM}}$ . The acceptable range for ILIM current is 500 mA - 3200 mA.
OTG	6	DI	Boost mode enable pin. When this pin is pulled HIGH, boost mode is enabled. OTG pin cannot be floating.

(1) AI = Analog input, AO = Analog Output, AIO = Analog input Output, DI = Digital input, DO = Digital Output, DIO = Digital input Output, P = Power

(2) All capacitors are ceramic unless otherwise specified

**Pin Functions (continued)**

PIN		TYPE <sup>(1)</sup>	DESCRIPTION
NAME	NO.		
$\overline{PG}$	7	DO	Open drain active low power good indicator. Connect to the pull up rail through 10 k $\Omega$ resistor. LOW indicates a good input if the input voltage is between UVLO and ACOV, above SLEEP mode threshold, and input current limit is above 30 mA.
PMID	23	P	Connected to the drain of the reverse blocking MOSFET (RBFET) and the drain of HSFET. Place a 10- $\mu$ F capacitor <sup>(2)</sup> on PMID to GND.
REGN	22	P	PWM low side driver positive supply output. Internally, REGN is connected to the anode of the boot-strap diode. Connect a 4.7- $\mu$ F (10-V rating) ceramic capacitor <sup>(2)</sup> from REGN to analog GND. The capacitor should be placed close to the IC.
STAT	5	DO	Open-drain interrupt output. Connect the STAT pin to a logic rail via 10-k $\Omega$ resistor. The STAT pin indicates charger status. Charge in progress: LOW Charge complete or charger in SLEEP mode: HIGH Charge suspend (fault response): Blink at 1Hz
SW	19	P	Switching node connecting to output inductor. Internally SW is connected to the source of the n-channel HSFET and the drain of the n-channel LSFET. Connect the 0.047- $\mu$ F bootstrap capacitor from SW to BTST.
	20		
SYS	15	P	System output connection point. The internal current sensing resistor is connected between SYS and BAT. Connect a 10 $\mu$ F (min) capacitor <sup>(2)</sup> close to the SYS pin.
	16		
TS	11	AI	Battery temperature qualification voltage input. Connect a negative temperature coefficient thermistor (NTC). Program temperature window with a resistor divider from REGN to TS to GND. Charge and boost mode suspend when TS pin voltage is out of range. When TS pin is not used, connect a 10-k $\Omega$ resistor from REGN to TS and a 10-k $\Omega$ resistor from TS to GND or set TS_IGNORE to HIGH to ignore TS pin. It is recommended to use a 103AT-2 thermistor. BQ25616 supports hot/cold profile and BQ25616J supports JEITA profile.
VAC	1	P	Charger input voltage sensing. Optional external n-channel ACFET is placed between VAC and VBUS. When VAC voltage is below ACOV threshold (14.2-V) and above UVLO, ACFET turns on to connect VAC to VBUS, and power up the charger IC. Short VAC and VBUS if ACFET is not to be used.
VBUS	24	P	Charger input voltage. The internal n-channel reverse block MOSFET (RBFET) is connected between VBUS and PMID with VBUS on source. Place a 1- $\mu$ F ceramic capacitor <sup>(2)</sup> from VBUS to GND and place it as close as possible to the device.
VSET	12	AI	VSET pin sets default battery charge voltage. Program battery regulation voltage with a resistor pull-down from VSET to GND. $R_{VSET} > 50k\Omega$ (float pin) = 4.208 V $R_{VSET} < 500\Omega$ (short to GND) = 4.352 V $5k\Omega < R_{VSET} < 25k\Omega$ = 4.100 V
Thermal Pad	—	P	Ground reference for the device that is also the thermal pad used to conduct heat from the device. This connection serves two purposes. The first purpose is to provide an electrical ground connection for the device. The second purpose is to provide a low thermal-impedance path from the device die to the PCB. This pad should be tied externally to a ground plane.

## 8 Specifications

### 8.1 Absolute Maximum Ratings

over operating free-air temperature range (unless otherwise noted)<sup>(1)</sup>

		MIN	MAX	UNIT
Voltage	VAC (converter not switching)	-2	30	V
Voltage	VBUS (converter not switching)	-2	22	V
Voltage	PMID (converter not switching)	-0.3	22	V
Voltage	SW	-0.3	16	V
Voltage	BAT, SYS (converter not switching)	-0.3	17	V
Voltage	BTST	-0.3	22	V
Voltage	ACDRV	-0.3	40	V
Voltage	D+, D-, STAT, OTG, $\overline{\text{PG}}$ , ILIM, $\overline{\text{CE}}$ , ICHG, TS, VSET	-0.3	7	V
Output Sink Current	STAT, $\overline{\text{PG}}$		6	mA
T <sub>J</sub>	Junction temperature	-40	150	°C
T <sub>stg</sub>	Storage temperature	-55	150	°C

- (1) Stresses beyond those listed under *Absolute Maximum Rating* may cause permanent damage to the device. These are stress ratings only, which do not imply functional operation of the device at these or any other conditions beyond those indicated under *Recommended Operating Condition*. Exposure to absolute-maximum-rated conditions for extended periods may affect device reliability.

### 8.2 ESD Ratings

			VALUE	UNIT
V <sub>(ESD)</sub>	Electrostatic discharge	Human body model (HBM), per ANSI/ESDA/JEDEC JS-001, all pins <sup>(1)</sup>	±2000	V
		Charged device model (CDM), per JEDEC specification JESD22-C101, all pins <sup>(2)</sup>	±250	

- (1) JEDEC document JEP155 states that 500-V HBM allows safe manufacturing with a standard ESD control process.  
(2) JEDEC document JEP157 states that 250-V CDM allows safe manufacturing with a standard ESD control process.

### 8.3 Recommended Operating Conditions

over operating free-air temperature range (unless otherwise noted)

		MIN	NOM	MAX	UNIT
V <sub>VBUS</sub>	Input voltage	4		13.5	V
V <sub>BAT</sub>	Battery voltage			4.35	V
I <sub>VBUS</sub>	Input current			3.2	A
I <sub>SW</sub>	Output current (SW)			3.2	A
I <sub>BAT</sub>	Fast charging current			3	A
	RMS discharge current			6	A
T <sub>A</sub>	Ambient temperature	-40		85	°C

### 8.4 Thermal Information

THERMAL METRIC <sup>(1)</sup>		BQ25616/BQ25616J	
		RTW (WQFN)	
		24 Pins	
		UNIT	
R <sub>θJA</sub>	Junction-to-ambient thermal resistance (JEDEC <sup>(1)</sup> )	31.9	°C/W
R <sub>θJC(top)</sub>	Junction-to-case (top) thermal resistance	27	°C/W
R <sub>θJB</sub>	Junction-to-board thermal resistance	9.2	°C/W
Ψ <sub>JT</sub>	Junction-to-top characterization parameter	0.4	°C/W
Ψ <sub>JB</sub>	Junction-to-board characterization parameter	9.2	°C/W

- (1) For more information about traditional and new thermal metrics, see the [Semiconductor and IC Package Thermal Metrics](#) application report.

**Thermal Information (continued)**

THERMAL METRIC <sup>(1)</sup>		BQ25616/BQ25616J	
		RTW (WQFN)	
		24 Pins	
R <sub>θJC(bot)</sub>	Junction-to-case (bottom) thermal resistance	2.8	°C/W

**8.5 Electrical Characteristics**

$V_{VBUS\_UVLOZ} < V_{VBUS} < V_{VBUS\_OV}$  and  $V_{VBUS} > V_{BAT} + V_{SLEEP}$ ,  $T_J = -40^{\circ}\text{C}$  to  $+125^{\circ}\text{C}$ , and  $T_J = 25^{\circ}\text{C}$  for typical values (unless otherwise noted)

PARAMETER		TEST CONDITIONS	MIN	TYP	MAX	UNIT
<b>QUIESCENT CURRENTS</b>						
I <sub>Q_BAT</sub>	Quiescent battery current (BAT, SYS, SW)	VBAT = 4.5V, VBUS floating or VBUS = 0V - 5V, SCL, SDA = 0V or 1.8V, T <sub>J</sub> < 85 °C, BATFET on.		9.5	15	μA
I <sub>VBUS</sub>	Input current (VBUS) in buck mode when converter is switching	VBUS=5V, charge disabled, converter switching, ISYS = 0A		2.3		mA
I <sub>BST</sub>	Quiescent battery current (BAT, SYS, SW) in boost mode when converter is switching	VBAT = 4.5V, VBUS = 4.9V, boost mode enabled, converter switching, I <sub>VBUS</sub> = 0A		2.4		mA
<b>VBUS / VBAT SUPPLY</b>						
V <sub>VBUS\_OP</sub>	VBUS operating range		4		13.5	V
V <sub>VAC\_UVLOZ</sub>	VAC rising for ACFET turnon, no battery	VAC rising		3.55	3.85	V
V <sub>VAC\_UVLO</sub>	VAC falling for ACFET turnoff, no battery	VAC falling		3.25	3.55	V
V <sub>ACDRV</sub>	External ACFET gate drive voltage with minimum 8nF CGS			10		V
V <sub>VBUS\_UVLOZ</sub>	VBUS rising for active bias, no battery	VBUS rising		3.3	3.7	V
V <sub>VBUS\_UVLO</sub>	VBUS falling to turnoff bias, no battery	VBUS falling		3	3.3	V
V <sub>VBUS\_PRESENT</sub>	VBUS to enable REGN	VBUS rising		3.65	3.9	V
V <sub>VBUS\_PRESENTZ</sub>	VBUS to disable REGN	VBUS falling		3.15	3.4	V
V <sub>SLEEP</sub>	Enter Sleep mode threshold	VBUS falling, VBUS - VBAT, VBAT = 4V	15	60	110	mV
V <sub>SLEEPZ</sub>	Exit Sleep mode threshold	VBUS rising, VBUS - VBAT, VBAT = 4V	115	220	340	mV
V <sub>ACOV</sub>	VAC overvoltage rising threshold to turnoff ACFET and switching	VAC rising	13.5	14.2	14.85	V
	VAC overvoltage falling threshold to turnon ACFET and switching	VAC falling,	13	13.9	14.5	V
V <sub>BAT\_UVLOZ</sub>	BAT voltage for active bias, no VBUS	VBAT rising	2.5			V
V <sub>BAT\_DPLZ</sub>	BAT depletion rising threshold to turn on BATFET	VBAT rising	2.35		2.8	V
V <sub>BAT\_DPL</sub>	BAT depletion falling threshold to turn off BATFET	VBAT falling	2.18		2.62	V
V <sub>POORSRC</sub>	Bad adapter detection threshold	VBUS falling	3.75	3.9	4.0	V
<b>POWER-PATH MANAGEMENT</b>						
V <sub>SYS\_MIN</sub>	Typical minimum system regulation voltage	VBAT=3.2V < SYS_MIN = 3.5V, ISYS = 0A	3.5	3.65		V
V <sub>SYS\_OVP</sub>	System overvoltage threshold	VREG = 4.35V, Charge disabled, ISYS = 0A		4.7		V
R <sub>ON\_RBFET</sub>	Blocking FET on-resistance			45		mΩ
R <sub>ON\_HSFET</sub>	High-side switching FET on-resistance			62		mΩ
R <sub>ON\_LSFET</sub>	Low-side switching FET on-resistance			71		mΩ
V <sub>BATFET\_FWD</sub>	BATFET forward voltage in supplement mode	BAT discharge current 10mA, converter running		30		mV



**Electrical Characteristics (continued)**
 $V_{VBUS\_UVLOZ} < V_{VBUS} < V_{VBUS\_OV}$  and  $V_{VBUS} > V_{BAT} + V_{SLEEP}$ ,  $T_J = -40^{\circ}\text{C}$  to  $+125^{\circ}\text{C}$ , and  $T_J = 25^{\circ}\text{C}$  for typical values (unless otherwise noted)

PARAMETER		TEST CONDITIONS	MIN	TYP	MAX	UNIT
<b>BATTERY CHARGER</b>						
$V_{REG\_ACC}$	Charge voltage accuracy	$V_{REG} = 4.1\text{V}$ , $R_{VSET}=10\text{k}\Omega$ , $T_J = 0^{\circ}\text{C} - 85^{\circ}\text{C}$	4.0836	4.1	4.1164	V
		$V_{REG} = 4.2\text{V}$ , $R_{VSET}>50\text{k}\Omega$ , $T_J = 0^{\circ}\text{C} - 85^{\circ}\text{C}$	4.1832	4.2	4.2168	V
		$V_{REG} = 4.35\text{V}$ , $R_{VSET}<500\Omega$ , $T_J = 0^{\circ}\text{C} - 85^{\circ}\text{C}$	4.3326	4.35	4.3674	V
$I_{CHG\_RANGE}$	Typical charge current regulation range		0		3	A
$K_{ICHG}$	ICHG pin setting ratio	$ICHG=K_{ICHG}/R_{ICHG}$ , $V_{BAT} = 3.1\text{V}$ , $T_J = -40^{\circ}\text{C} - 85^{\circ}\text{C}$	639	677	715	$Ax\Omega$
		$ICHG=K_{ICHG}/R_{ICHG}$ , $V_{BAT} = 3.8\text{V}$ , $T_J = -40^{\circ}\text{C} - 85^{\circ}\text{C}$	639	677	715	$Ax\Omega$
$I_{CHG\_ACC}$	Fast charge current regulation accuracy	$R_{ICHG} = 1100\ \Omega$ , $V_{BAT} = 3.1\text{V}$ or $3.8\text{V}$ , $T_J = -40^{\circ}\text{C} - 85^{\circ}\text{C}$	0.516	0.615	0.715	A
		$R_{ICHG} = 562\ \Omega$ , $V_{BAT} = 3.1\text{V}$ or $3.8\text{V}$ , $T_J = -40^{\circ}\text{C} - 85^{\circ}\text{C}$	1.14	1.205	1.28	A
		$R_{ICHG} = 372\ \Omega$ , $V_{BAT} = 3.1\text{V}$ or $3.8\text{V}$ , $T_J = -40^{\circ}\text{C} - 85^{\circ}\text{C}$	1.715	1.82	1.89	A
$I_{PRECHG\_RATIO}$	Precharge current accuracy	As percentage of ICHG, $V_{BAT} = 2.6\text{V}$		5		%
$I_{PRECHG\_ACC}$	Precharge current accuracy	$R_{ICHG} = 1100\ \Omega$ , $V_{BAT} = 2.6\text{V}$ , $T_J = -40^{\circ}\text{C} - 85^{\circ}\text{C}$	21	30	38	mA
		$R_{ICHG} = 562\ \Omega$ , $V_{BAT} = 2.6\text{V}$ , $T_J = -40^{\circ}\text{C} - 85^{\circ}\text{C}$	48	60	67	mA
		$R_{ICHG} = 372\ \Omega$ , $V_{BAT} = 2.6\text{V}$ , $T_J = -40^{\circ}\text{C} - 85^{\circ}\text{C}$	76	90	97	mA
$I_{TERM\_RATIO}$	Termination current accuracy	As percentage of ICHG, $V_{BAT} = 4.35\text{V}$ , (char, all codes)		5		%
$I_{TERM\_ACC}$	Termination current accuracy	$R_{ICHG} = 1100\ \Omega$ , $V_{BAT} = 4.35\text{V}$ , $T_J = 0^{\circ}\text{C} - 85^{\circ}\text{C}$	9	31	57	mA
		$R_{ICHG} = 562\ \Omega$ , $V_{BAT} = 4.35\text{V}$ , $T_J = 0^{\circ}\text{C} - 85^{\circ}\text{C}$	36	60	85	mA
		$R_{ICHG} = 372\ \Omega$ , $V_{BAT} = 4.35\text{V}$ , $T_J = 0^{\circ}\text{C} - 85^{\circ}\text{C}$	56	91	126	mA
$V_{BAT\_SHORTZ}$	Battery short voltage rising threshold to start pre-charge	VBAT rising	2.13	2.25	2.35	V
$V_{BAT\_SHORT}$	Battery short voltage falling threshold to stop pre-charge	VBAT falling	1.85	2	2.15	V
$I_{BAT\_SHORT}$	Battery short trickle charging current	$V_{BAT} < V_{BAT\_SHORTZ}$	70	90	110	mA
$V_{BATLOWV}$	Battery LOWV rising threshold to start fast-charge	VBAT rising	3	3.12	3.24	V
	Battery LOWV falling threshold to stop fast-charge	VBAT falling	2.7	2.8	2.9	V
$V_{RECHG}$	Battery recharge threshold	VBAT falling	90	100	150	mV
$I_{SYS\_LOAD}$	System discharge load current during SYSOVP			30		mA
$R_{ON\_BATFET}$	Battery FET on-resistance	$T_J = -40^{\circ}\text{C} - 85^{\circ}\text{C}$		19.5	26	$\text{m}\Omega$
		$T_J = -40^{\circ}\text{C} - 125^{\circ}\text{C}$		19.5	30	$\text{m}\Omega$
<b>BATTERY OVER-VOLTAGE PROTECTION</b>						
$V_{BAT\_OVP}$	Battery overvoltage rising threshold	VBAT rising, as percentage of VREG	103	104	105	%
	Battery overvoltage falling threshold	VBAT falling, as percentage of VREG	101	102	103	%
<b>INPUT VOLTAGE / CURRENT REGULATION</b>						

## Electrical Characteristics (continued)

$V_{VBUS\_UVLOZ} < V_{VBUS} < V_{VBUS\_OV}$  and  $V_{VBUS} > V_{BAT} + V_{SLEEP}$ ,  $T_J = -40^{\circ}\text{C}$  to  $+125^{\circ}\text{C}$ , and  $T_J = 25^{\circ}\text{C}$  for typical values (unless otherwise noted)

PARAMETER		TEST CONDITIONS	MIN	TYP	MAX	UNIT
$V_{INDPM\_ACC}$	Typical input voltage regulation accuracy		4.171	4.3	4.429	V
$V_{INDPM\_TRACK}$	VINDPM threshold to track battery voltage	$V_{BAT} = 4.35\text{V}$	4.45	4.55	4.74	V
$I_{INDPM\_ACC}$	Input current regulation accuracy	$I_{INDPM} = 500\text{mA}$ ( $T_J = -40^{\circ}\text{C} - 85^{\circ}\text{C}$ )	450	465	500	mA
$I_{INDPM\_ACC}$	Input current regulation accuracy	$I_{INDPM} = 900\text{mA}$ ( $T_J = -40^{\circ}\text{C} - 85^{\circ}\text{C}$ )	750	835	900	mA
$I_{INDPM\_ACC}$	Input current regulation accuracy	$I_{INDPM} = 1500\text{mA}$ ( $T_J = -40^{\circ}\text{C} - 85^{\circ}\text{C}$ )	1300	1390	1500	mA
$K_{ILIM}$	ILIM pin setting ratio		459	478	500	A x $\Omega$
<b>D+ / D- Detection</b>						
$V_{DP\_SRC}$	D+ line source voltage		500	600	700	mV
$I_{DP\_SRC}$	D+ line data contact detect current source	$V_{D+} = 200\text{ mV}$ ,	7	10	14	$\mu\text{A}$
$I_{DP\_SINK}$	D+ line sink current	$V_{D+} = 500\text{ mV}$ ,	50	100	150	$\mu\text{A}$
$V_{DP\_DAT\_REF}$	D+ line data detect voltage	D+ pin Rising, DPDM_NSCOMP2	250		400	mV
$V_{DP\_LGC\_LOW}$	D+ line logic low.	D+ pin Rising, DPDM_NSCOMP2			800	mV
$R_{DP\_DWN}$	D+ line pull-down resistance	$V_{D+} = 500\text{mV}$	14.25		24.8	k $\Omega$
$I_{D+\_LKG}$	Leakage current into D+ line	Pull up to 1.8V	-1		1	$\mu\text{A}$
$V_{DM\_SRC}$	D- line source voltage		500	600	700	mV
$I_{DM\_SINK}$	D- line sink current	$V_{D-} = 500\text{ mV}$ ,	50	100	150	$\mu\text{A}$
$V_{DM\_DAT\_REF}$	D- line data detect voltage	D- pin Rising, DPDM_NSCOMP2	250		400	mV
$R_{DM\_DWN}$	D- line pull-down resistance	$V_{D-} = 500\text{mV}$	14.25		24.8	k $\Omega$
$I_{D-\_LKG}$	Leakage current into D- line	Pull up to 1.8V	-1		1	$\mu\text{A}$
$V_{D+\_2p8\_hi}$	D+ High comparator threshold for 2.8V detection	D+ pin rising, DPDM_NSCOMP2	2.85	3	3.1	V
$V_{D+\_2p8\_lo}$	D+ Low comparator threshold for 2.8V detection	D+ pin rising, NSCMP1Z	2.35	2.45	2.55	V
$V_{D+\_2p8}$	D+ comparator threshold for non-standard adapter	(combined $V_{D+\_2p8\_hi}$ and $V_{D+\_2p8\_lo}$ )	2.55		2.85	V
$V_{D-\_2p8\_hi}$	D- High comparator threshold for 2.8V detection	D- pin rising, DPDM_NSCOMP2	2.85	3	3.1	V
$V_{D-\_2p8\_lo}$	D- Low comparator threshold for 2.8V detection	D- pin rising, NSCMP1Z	2.35	2.45	2.55	V
$V_{D-\_2p8}$	D- comparator threshold for non-standard adapter	(combined $V_{D-\_2p8\_hi}$ and $V_{D-\_2p8\_lo}$ )	2.55		2.85	V
$V_{D+\_2p0\_hi}$	D+ High comparator threshold for 2.0V detection	D+ pin rising, DPDM_NSCOMP2	2.15	2.25	2.35	V
$V_{D+\_2p0\_lo}$	D+ Low comparator threshold for 2.0V detection	D+ pin rising, NSCMP1Z	1.6	1.7	1.85	V
$V_{D+\_2p0}$	D+ comparator threshold for non-standard adapter	(combined $V_{D+\_2p0\_hi}$ and $V_{D+\_2p0\_lo}$ )	1.85		2.15	V
$V_{D-\_2p0\_hi}$	D- High comparator threshold for 2.0V detection	D- pin rising, DPDM_NSCOMP2	2.15	2.25	2.35	V
$V_{D-\_2p0\_lo}$	D- Low comparator threshold for 2.0V detection	D- pin rising, NSCMP1Z	1.6	1.7	1.85	V
$V_{D-\_2p0}$	D- comparator threshold for non-standard adapter	(combined $V_{D-\_2p0\_hi}$ and $V_{D-\_2p0\_lo}$ )	1.85		2.15	V
$V_{D+\_1p2\_hi}$	D+ High comparator threshold for 1.2V detection	D+ pin rising, DPDM_NSCOMP2	1.35	1.5	1.6	V
$V_{D+\_1p2\_lo}$	D+ Low comparator threshold for 1.2V detection	D+ pin rising, NSCPM1Z	0.85	0.95	1.05	V

**Electrical Characteristics (continued)**

$V_{VBUS\_UVLOZ} < V_{VBUS} < V_{VBUS\_OV}$  and  $V_{VBUS} > V_{BAT} + V_{SLEEP}$ ,  $T_J = -40^{\circ}\text{C}$  to  $+125^{\circ}\text{C}$ , and  $T_J = 25^{\circ}\text{C}$  for typical values (unless otherwise noted)

PARAMETER		TEST CONDITIONS	MIN	TYP	MAX	UNIT
$V_{D+\_1p2}$	D+ comparator threshold for non-standard adapter	(combined $V_{D+\_1p2\_hi}$ and $V_{D+\_1p2\_lo}$ )	1.05		1.35	V
$V_{D-\_1p2\_hi}$	D- High comparator threshold for 1.2V detection	D- pin rising, DPDM_NSCOMP2	1.35	1.5	1.6	V
$V_{D-\_1p2\_lo}$	D- Low comparator threshold for 1.2V detection	D- pin rising, NSCMP1Z	0.85	0.95	1.05	V
$V_{D-\_1p2}$	D- comparator threshold for non-standard adapter	(combined $V_{D-\_1p2\_hi}$ and $V_{D-\_1p2\_lo}$ )	1.05		1.35	V
$V_{D+/D-\_2p8}$	D+/D- comparator threshold for non-standard adapter		2.55		2.85	V
$V_{D+/D-\_2p0}$	D+/D- comparator threshold for non-standard adapter		1.85		2.15	V
$V_{D+/D-\_1p2}$	D+/D- comparator threshold for non-standard adapter		1.05		1.35	V
<b>THERMAL REGULATION AND THERMAL SHUTDOWN</b>						
$T_{REG}$	Junction temperature regulation accuracy			110		$^{\circ}\text{C}$
$T_{SHUT}$	Thermal Shutdown Rising threshold	Temperature Increasing		150		$^{\circ}\text{C}$
	Thermal Shutdown Falling threshold	Temperature Decreasing		130		$^{\circ}\text{C}$
<b>CHARGE MODE THERMISTOR COMPARATOR (JEITA 616J or HOT/COLD 616)</b>						
$V_{T1\_RISE\%}$	TS pin voltage rising threshold, Charge suspended above this voltage.	As Percentage to REGN ( $0^{\circ}\text{C}$ w/ 103AT)	72.4	73.3	74.2	%
$V_{T1\_FALL\%}$	TS pin voltage falling threshold. Charge re-enabled to 20% of ICHG and VREG below this voltage.	As Percentage to REGN	71.5	72	72.5	%
$V_{T2\_RISE\%}$	TS pin voltage rising threshold, Charge back to 20% of ICHG and VREG above this voltage (616J).	As Percentage to REGN ( $10^{\circ}\text{C}$ w/ 103AT)	67.75	68.25	68.75	%
$V_{T2\_FALL\%}$	TS pin voltage falling threshold. Charge back to ICHG and VREG below this voltage (616J)	As Percentage to REGN	66.45	66.95	67.45	%
$V_{T3\_FALL\%}$	TS pin voltage falling threshold. Charge back to ICHG and VREG below this voltage (616J)	As Percentage to REGN ( $45^{\circ}\text{C}$ w/ 103AT)	44.25	44.75	45.25	%
$V_{T3\_RISE\%}$	TS pin voltage rising threshold. Charge back to ICHG and VREG above this voltage. (616J)	As Percentage to REGN	45.55	46.05	46.55	%
$V_{T5\_FALL\%}$	TS pin voltage falling threshold, charge suspended below this voltage.	As Percentage to REGN ( $60^{\circ}\text{C}$ w/ 103AT)	33.7	34.2	35.1	%
$V_{T5\_RISE\%}$	TS pin voltage rising threshold. Charge back to ICHG and 4.1V above this voltage.	As Percentage to REGN	35	35.5	36	%
$V_{T1\_RISE\_HC\%}$	TS pin voltage rising threshold. Charge suspended above this voltage. (616)	As Percentage to REGN ( $0^{\circ}\text{C}$ w/ 103AT)	72.4	73.3	74.2	%
$V_{T1\_FALL\_HC\%}$	TS pin voltage falling threshold. Charge back to ICHG and VREG below this voltage. (616)	As Percentage to REGN	71	72	73	%
$V_{T3\_FALL\_HC\%}$	TS pin voltage falling threshold. Charge suspended below this voltage. (616)	As Percentage to REGN ( $45^{\circ}\text{C}$ w/ 103AT)	44.25	44.75	45.25	%
$V_{T3\_RISE\_HC\%}$	TS pin voltage rising threshold. Charge back to ICHG and VREG above this voltage. (616)	As Percentage to REGN	45.55	46.05	46.55	%
<b>BOOST MODE THERMISTOR COMPARATOR (HOT/COLD)</b>						

## Electrical Characteristics (continued)

$V_{VBUS\_UVLOZ} < V_{VBUS} < V_{VBUS\_OV}$  and  $V_{VBUS} > V_{BAT} + V_{SLEEP}$ ,  $T_J = -40^{\circ}\text{C}$  to  $+125^{\circ}\text{C}$ , and  $T_J = 25^{\circ}\text{C}$  for typical values (unless otherwise noted)

PARAMETER		TEST CONDITIONS	MIN	TYP	MAX	UNIT
$V_{BCOLD\_RISE\%}$	TS pin voltage rising threshold, boost mode is suspended above this voltage.	As Percentage to REGN ( $-19.5^{\circ}\text{C}$ w/ 103AT)	79.5	80	80.5	%
$V_{BCOLD\_FALL\%}$	TS pin voltage falling threshold	As Percentage to REGN ( $0^{\circ}\text{C}$ w/ 103AT)		72		%
$V_{BHOT\_FALL\%}$	TS pin voltage threshold. boost mode is suspended below this voltage.	As Percentage to REGN, ( $64^{\circ}\text{C}$ w/ 103AT)	30.2	31.2	32.2	%
$V_{BHOT\_RISE\%}$	TS pin voltage rising threshold	As Percentage to REGN, ( $45^{\circ}\text{C}$ w/ 103AT)		44		%
<b>SWITCHING CONVERTER</b>						
$F_{SW}$	PWM switching frequency	Oscillator frequency	1.32	1.5	1.68	MHz
$D_{MAX}$	Maximum PWM Duty Cycle			97		%
<b>BOOST MODE CONVERTER</b>						
$V_{BST\_BAT}$	Battery voltage exiting boost mode	BAT falling	2.4	2.5	2.6	V
$V_{BST\_ACC}$	Boost mode voltage regulation accuracy	IVBUS = 0A, BOOST_V = 5V	4.85	5	5.15	V
$I_{BST\_ACC}$	Boost mode current regulation accuracy		1.2	1.4	1.6	A
$I_{BST\_OCP\_Q1}$	Boost mode battery discharge current clamp on RBFET Q1	BOOST_LIM = 0.5 A	0.5		0.72	A
$I_{SYS\_OCP\_Q4}$	Boost mode battery discharge current clamp on BATFET Q4		9	10		A
<b>REGN LDO</b>						
$V_{REGN}$	REGN LDO output voltage	$V_{VBUS} = 5\text{V}$ , $I_{REGN} = 20\text{mA}$	4.58	4.7	4.8	V
		$V_{VBUS} = 9\text{V}$ , $I_{REGN} = 20\text{mA}$	5.6	6	6.5	V
$I_{REGN}$	REGN LDO current limit	$V_{VBUS} = 5\text{V}$ , $V_{REGN} = 3.8\text{V}$	50			mA
<b>LOGIC INPUT PIN</b>						
$V_{IH}$	Input high threshold level (/CE)		1.3			V
$V_{IL}$	Input low threshold level (/CE)				0.4	V
$I_{IN\_BIAS}$	High-level leakage current (/CE)	Pull up rail 1.8V			1	$\mu\text{A}$
<b>LOGIC OUTPUT PIN</b>						
$V_{OL}$	Output low threshold level (STAT, /PG)	Sink current = 5mA			0.4	V
$I_{OUT\_BIAS}$	High-level leakage current (STAT, /PG)	Pull up rail 1.8V			1	$\mu\text{A}$

## 8.6 Timing Requirements

		MIN	NOM	MAX	UNIT
<b>VBUS / VBAT POWER UP</b>					
$t_{POORSRC}$	Bad adapter detection duration		30		ms
$t_{POORSRC\_RETRY}$	Bad adapter detection retry wait time		2		s
<b>BATTERY CHARGER</b>					
$t_{TERM\_DGL}$	Deglitch time for charge termination		30		ms
$t_{RECHG\_DGL}$	Deglitch time for recharge threshold		30		ms
$t_{TOP\_OFF}$	Typical top-off timer accuracy		30		min
$t_{SAFETY}$	Charge safety timer accuracy, CHG_TIMER = 20hr	17	20	24	hr

### 8.7 Typical Characteristics

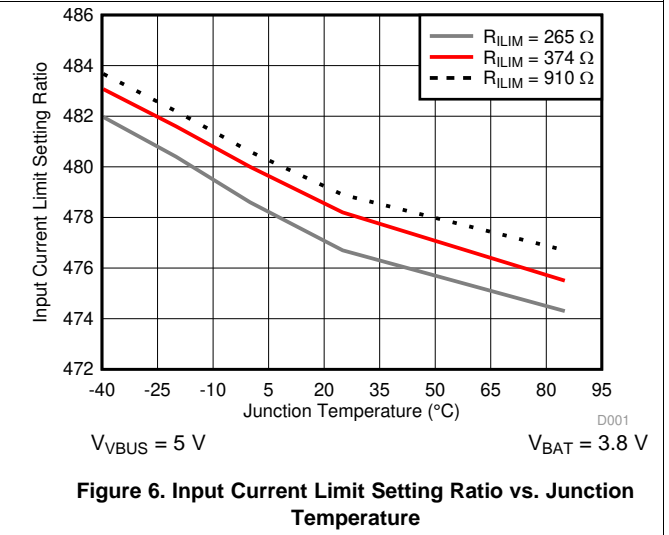
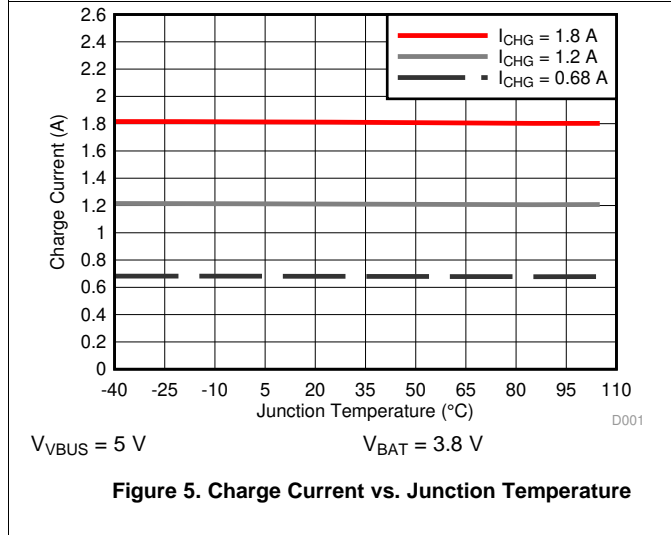
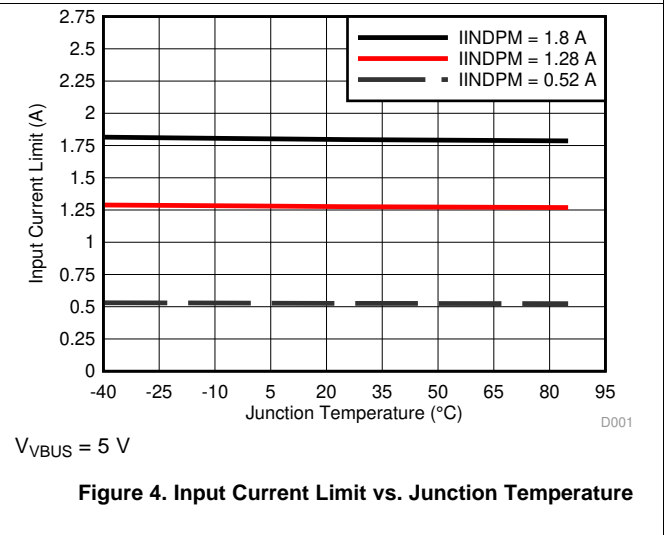
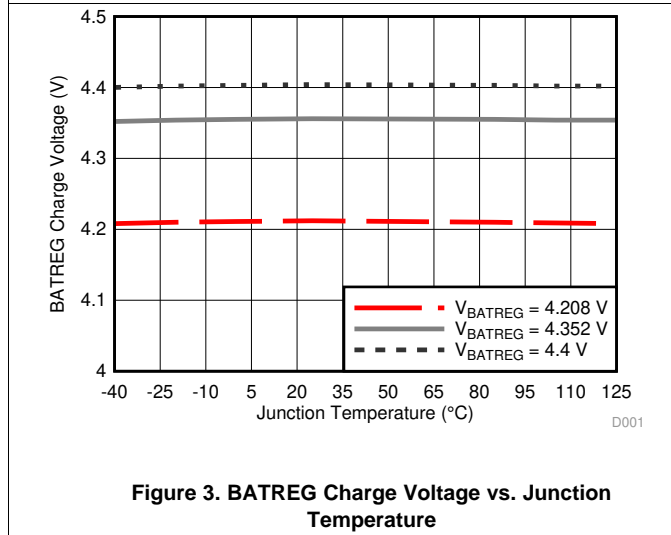
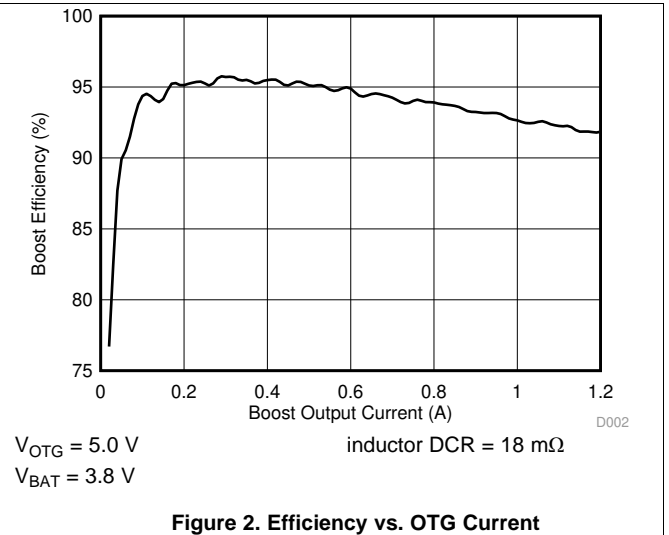
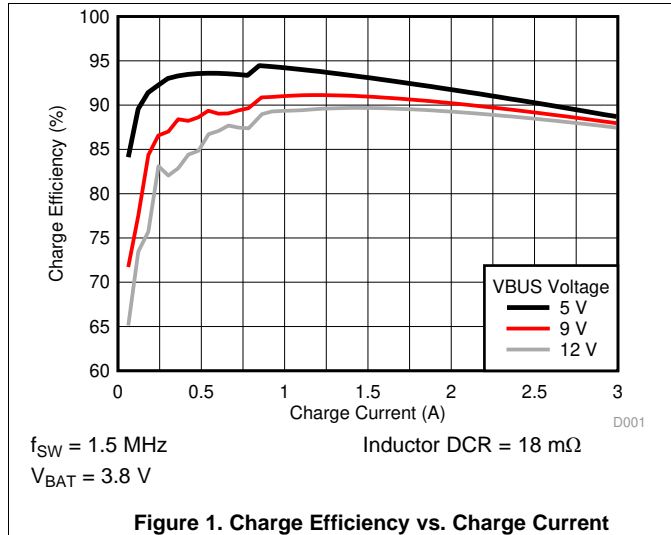

**Typical Characteristics (continued)**

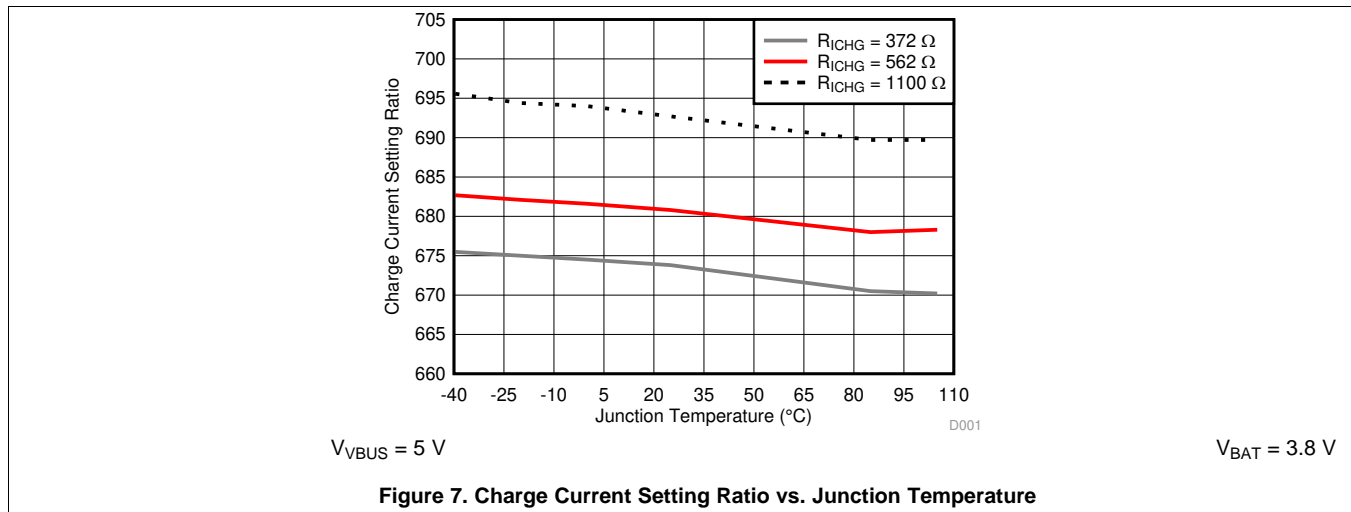

## 9 Detailed Description

### 9.1 Overview

The BQ25616/616J device is a highly integrated 3.0-A switch-mode battery charger for single cell Li-Ion and Li-polymer battery. It includes the input reverse-blocking FET (RBFET, Q1), high-side switching FET (HSFET, Q2), low-side switching FET (LSFET, Q3), and battery FET (BATFET, Q4), and bootstrap diode for the high-side gate drive.

### 9.2 Functional Block Diagram

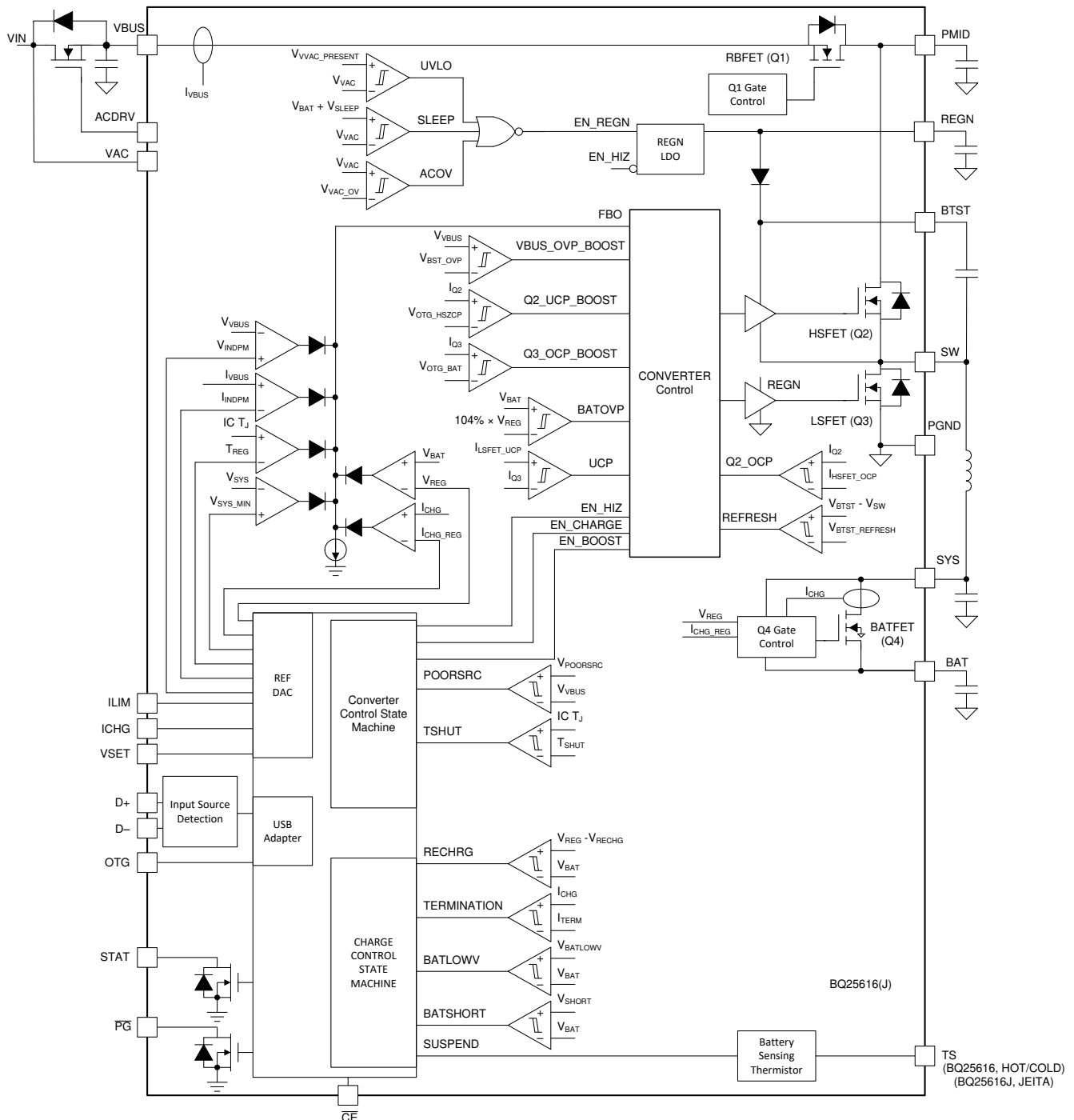

## 9.3 Feature Description

### 9.3.1 Power-On-Reset (POR)

The device powers internal bias circuits from the higher voltage of VBUS and BAT. When  $V_{VBUS}$  rises above  $V_{VBUS\_UVLOZ}$  or  $V_{BAT}$  rises above  $V_{BAT\_UVLOZ}$ , the sleep comparator, battery depletion comparator and BATFET driver are active.

### 9.3.2 Device Power Up from Battery without Input Source

If only the battery is present and the voltage is above depletion threshold ( $V_{BAT\_DPLZ}$ ), the BATFET turns on and connects the battery to the system. The REGN stays off to minimize the quiescent current. The low  $R_{DSON}$  of BATFET and the low quiescent current on BAT minimize the conduction loss and maximize the battery run time.

The device always monitors the discharge current through BATFET. When the system is overloaded or shorted ( $I_{BAT} > I_{SYS\_OCP\_Q4}$ ), the device turns off BATFET immediately until the input source plugs in again.

### 9.3.3 Power Up from Input Source

When an input source is plugged in, the device checks the input source voltage to turn on the REGN LDO and all the bias circuits. It detects and sets the input current limit before the buck converter is started. The power up sequence from input source is as listed:

1. Power Up ACFET, see [Power Up ACFET](#) section (optional)
2. Power Up REGN LDO, see [Power Up REGN LDO](#) section
3. Poor Source Qualification, see [Poor Source Qualification](#) section
4. Input Source Type Detection is based on D+/D– to set default input current limit (IINDPM threshold), see [Input Source Type Detection \(IINDPM Threshold\)](#) section
5. Input Voltage Limit Threshold Setting (VINDPM threshold), see [Input Voltage Limit Threshold Setting \(VINDPM Threshold\)](#) section
6. Power Up Converter, see [Power Up Converter in Buck Mode](#) section

#### 9.3.3.1 Power Up ACFET

The external ACFET provides an additional layer of voltage protection for the device. During input surge up to 30 V, the charger turns off ACFET and converter with 130-ns response time to disconnect VBUS from VAC. If users don't need ACFET, they shall connect VAC to VBUS and keep ACDRV pin floating. The ACFET is enabled when all the below conditions are valid.

The ACFET is enabled when all the below conditions are valid.

- $V_{VAC\_PRESENT} < V_{VAC} < V_{ACOV}$ .
- After  $t_{DEB}$  (15 ms typ) delay is completed

If one of the above conditions is not valid, ACFET keeps off. The battery powers the system if it is present.



## Feature Description (continued)

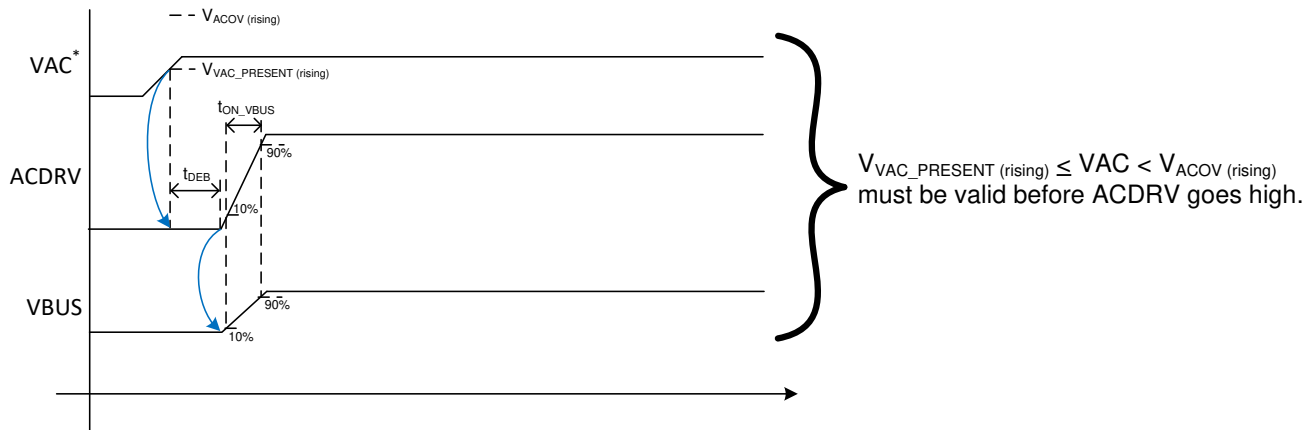

(\*) Stimulus from application  
Note: beginning of blue lines indicate the trigger, and the arrow end of the blue line indicates the action

Figure 8. ACFET Startup Control

### 9.3.3.2 Power Up REGN LDO

The REGN LDO supplies internal bias circuits as well as the HSFET and LSFET gate drive. It also provides the bias rail to TS external resistors. The pull-up rail of STAT can be connected to REGN as well. The REGN LDO is enabled when all the below conditions are valid:

- $V_{VBUS} > V_{VBUS\_UVLOZ}$
- In buck mode, ACFET turns on,  $V_{VBUS} > V_{BAT} + V_{SLEEPZ}$
- In boost mode,  $V_{VBUS} < V_{BAT} + V_{SLEEPZ}$
- After 220-ms delay is completed

During high impedance mode, REGN LDO turns off. The battery powers up the system.

### 9.3.3.3 Poor Source Qualification

After the REGN LDO powers up, the device starts to check current capability of the input source. The first step is poor source detection.

- VBUS voltage above  $V_{POORSRC}$  when pulling  $I_{BADSRC}$  (typical 30 mA)

If the device fails the poor source detection, it repeats poor source qualification every 2 seconds.

### 9.3.3.4 Input Source Type Detection (IINDPM Threshold)

After poor source detection, the device runs input source detection through D+/D– lines. The D+/D– detection follows the USB Battery Charging Specification 1.2 (BC1.2) to detect standard (SDP/CDP/DCP) and non-standard adapters through USB D+/D– lines.

#### 9.3.3.4.1 D+/D– Detection Sets Input Current Limit

The device contains a D+/D– based input source detection to set the input current limit when a 5-V adapter is plugged-in. The D+/D– detection includes standard USB BC1.2 and non-standard adapters. When an input source is plugged in, the device starts standard USB BC1.2 detection. The USB BC1.2 is capable of identifying Standard Downstream Port (SDP), Charging Downstream Port (CDP) and Dedicated Charging Port (DCP). The non-standard detection is used to distinguish vendor specific adapters (Apple and Samsung) based on their unique dividers on the D+/D– pins. If an adapter is detected as DCP, the input current limit is set at 2.4-A. If an adapter is detected as unknown, the input current limit is set by ILIM pin.

The D+/D– automatically runs when adapter plugs in. The D+/D– detection contains three steps, DCD (Data Contact Detection), primary detection, and secondary detection.

## Feature Description (continued)

DCD (Data Contact Detection) uses a current source to detect when the D+/D– pins have made contact during an attach event. The protocol for data contact detect is as follows:

- Detect VBUS present and VBUS\_GD (pass poor source detection)
- Turn on D+ I<sub>DP\_SRC</sub> and the D– pull-down resistor R<sub>DM\_DWN</sub> for 13 ms
- If the USB connector is properly attached, the D+ line goes from HIGH to LOW, wait up to 0.5 sec. When the DCD timer of 0.5 sec is expired, the non-standard adapter detection is applied to set the input current limit.
- Turn off I<sub>DP\_SRC</sub> and disconnect R<sub>DM\_DWN</sub>

The primary detection is used to distinguish between USB host (Standard Down Stream Port, or SDP) and different type of charging ports (Charging Down Stream Port, or CDP, and Dedicated Charging Port, or DCP). The protocol for primary detection is as follows:

- Turn on V<sub>DP\_SRC</sub> on D+ and I<sub>DM\_Sink</sub> on D– for 40 ms
- If portable device is attached to a USB host (SDP), the D– is below V<sub>REF\_DAT</sub>. Otherwise, it is attached to either CDP or DCP.
- Turn off V<sub>DP\_SRC</sub> and I<sub>DM\_Sink</sub>

The secondary detection is used to distinguish two types of charging ports (CDP and DCP). The protocol for secondary detection is as follows:

- Turn on V<sub>DM\_SRC</sub> on D- and I<sub>DP\_Sink</sub> on D+ for 40 ms
- If portable device is attached to a Charging Downstream Port (CDP), the D+ is below V<sub>DAT\_REF</sub>. Otherwise, it is attached to DCP.
- Turn off V<sub>DM\_SRC</sub> and I<sub>DP\_Sink</sub>

Most of the time, a CDP requires the portable device (such as smart phone, tablet) to send back an enumeration within 2.5 seconds of CDP plug-in. Otherwise, the port will power cycle back to SDP even the D+/D– detection indicates CDP.

**Table 1. Non-Standard Adapter Detection**

NON-STANDARD ADAPTER	D+ THRESHOLD	D– THRESHOLD	INPUT CURRENT LIMIT (A)
Divider 1	V <sub>D+</sub> within V <sub>D+/D- _2p8</sub>	V <sub>D-</sub> within V <sub>D+/D- _2p0</sub>	2.1
Divider 2	V <sub>D+</sub> within V <sub>D+/D- _1p2</sub>	V <sub>D-</sub> within V <sub>D+/D- _1p2</sub>	2
Divider 3	V <sub>D+</sub> within V <sub>D+/D- _2p0</sub>	V <sub>D-</sub> within V <sub>D+/D- _2p8</sub>	1
Divider 4	V <sub>D+</sub> within V <sub>D+/D- _2p8</sub>	V <sub>D-</sub> within V <sub>D+/D- _2p8</sub>	2.4

**Table 2. Input Current Limit Setting from D+/D– Detection**

D+/D– DETECTION	INPUT CURRENT LIMIT (IINDPM)
USB CDP	1.5 A
USB DCP	2.4 A
Divider 1	2.1 A
Divider 2	2.0 A
Divider 3	1.0 A
Divider 4	2.4 A
Unknown 5-V Adapter	Set by ILIM pin

### 9.3.3.5 Input Voltage Limit Threshold Setting (VINDPM Threshold)

The device has two modes to set the VINDPM threshold.

- Fixed VINDPM threshold. The VINDPM is set at 4.3 V.
- VINDPM threshold tracks the battery voltage to optimize the converter headroom between input and output. The actual input voltage limit is the higher of the VINDPM setting (4.3-V) and V<sub>BAT</sub> + 200 mV.

### 9.3.3.6 Power Up Converter in Buck Mode

After the input current limit is set, the converter is enabled and the HSFET and LSFET start switching. The system voltage is powered from the converter instead of the battery. If battery charging is disabled, the BATFET turns off. Otherwise, the BATFET stays on to charge the battery.

The device provides soft-start when system rail is ramping up. When the system rail is below  $V_{BAT\_SHORT}$ , the input current is limited to 200-mA. The system load shall be appropriately planned not to exceed the 200-mA IINDPM limit. After the system rises above  $V_{BAT\_SHORTZ}$ , the device input current limit is the value set by ILIM pin.

As a battery charger, the device deploys a highly efficient 1.5-MHz step-down switching regulator. The fixed frequency oscillator keeps tight control of the switching frequency under all conditions of input voltage, battery voltage, charge current and temperature simplifying output filter design.

The converter supports PFM operation by default for fast transient response during system voltage regulation and better light load efficiency.

### 9.3.4 Boost Mode Operation From Battery

The device supports boost converter operation to deliver power from the battery to other portable devices through a USB port. The output voltage is regulated at 5-V and output current is up to 1.2 A with constant current regulation.

The boost operation is enabled if the conditions below are valid:

1. OTG pin HIGH
2. VBUS less than  $V_{BAT} + V_{SLEEP}$  (in sleep mode) before converter starts.
3. Voltage at TS (thermistor) pin, as a percentage of  $V_{REGN}$ , is within acceptable range ( $V_{BHOT\_RISE\%} < V_{TS\%} < V_{BCOLD\_FALL\%}$ )
4. After 30-ms delay from boost mode enable.
5. Not in any fault such as  $I_{SYS\_OCP\_Q4}$ , TSHUT, ACOV or VBUS OV.

The converter supports PFM operation at light load in boost mode.

### 9.3.5 Standalone Charger

The BQ25616/616J is a standalone device without host control. Any change on  $\overline{CE}$ , ICHG and ILIM pins will cause a real time internal reference change. Charging is enabled or disabled via the  $\overline{CE}$  pin. D+/D– and ILIM pins control the input current limit settings. D+/D– detection and VSET pin setting only takes effect upon adapter plug-in.

Charge current must be programmed to a value within a range of 300 mA to 3000 mA with a pull-down resistor on the ICHG pin. The charge current is set as:

$$I_{ICHG} = K_{ICHG}/R_{ICHG} \quad (1)$$

Input current limit must be programmed to a value within a range of 500 mA to 3200 mA with a pull-down resistor on the ILIM pin. The input current limit is set as:

$$I_{IINDPM} = K_{ILIM}/R_{ILIM} \quad (2)$$

The battery regulation voltage is programmed with a pull-down resistor on the VSET pin as follows:

- $R_{VSET} > 50 \text{ k}\Omega$  (float pin):  $V_{REG} = 4.20\text{-V}$
- $R_{VSET} < 500 \text{ }\Omega$  (short pin):  $V_{REG} = 4.35\text{-V}$
- $5\text{k}\Omega < R_{VSET} < 25 \text{ k}\Omega$ :  $V_{REG} = 4.10\text{-V}$

**Table 3. Standalone Device Configuration**

	<b>BQ25616/616J</b>
USB OTG	5 V/1.2 A
USB Detection	D+/D–
VINDPM	4.3 V and $V_{BAT} + 200 \text{ mV}$
VBUS Operating Range	4 V - 13.5 V

**Table 3. Standalone Device Configuration (continued)**

	BQ25616/616J
V <sub>REG</sub>	VSET pin (4.20 V, 4.35 V, or 4.10 V)
Safety Timer	10 hr fast charge
Pre-charge Timer	2 hr
I <sub>PRECHG</sub>	5% of I <sub>CHG</sub>
I <sub>TERM</sub>	5% of I <sub>CHG</sub>
Charging Temperature Profile	JEITA 0-60°C (BQ25616J), Hot/Cold 0-45°C (BQ25616)
OTG Temperature Profile	-20°C to +60°C

If a fault is detected, the STAT pin will blink at 1 Hz. STAT pin will stop blinking when the fault goes away. All faults will be reset upon adapter re-connection. A boost mode fault will be cleared either by adapter re-connection or toggling of the OTG pin.

**9.3.6 Power Path Management**

The device accommodates a wide range of input sources such as USB, wall adapter, or car charger. The device provides automatic power path selection to supply the system (SYS) from the input source (VBUS), battery (BAT), or both.

**9.3.6.1 Narrow VDC Architecture**

When the battery is below the minimum system voltage setting, the BATFET operates in linear mode (LDO mode), and the system is typically 180 mV above the minimum system voltage setting. As the battery voltage rises above the minimum system voltage, the BATFET is fully on and the voltage difference between the system and battery is the V<sub>DS</sub> of the BATFET.

When battery charging is disabled and above the minimum system voltage setting or charging is terminated, the system is always regulated at typically 50 mV above the battery voltage.

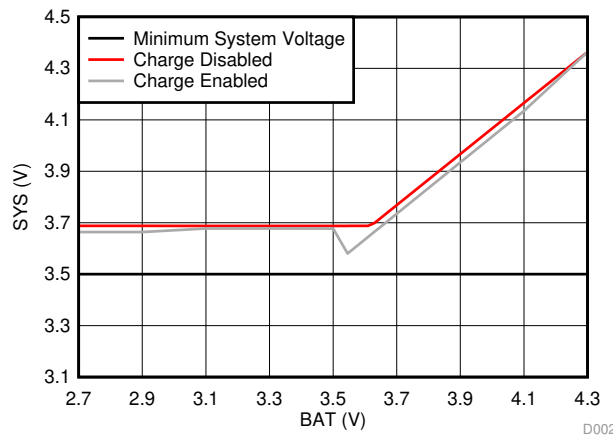

**Figure 9. System Voltage vs Battery Voltage**

**9.3.6.2 Dynamic Power Management**

To meet the maximum current limit in the USB specification and avoid overloading the adapter, the device features Dynamic Power Management (DPM), which continuously monitors the input current and input voltage. When input source is overloaded, either the current exceeds the input current limit (IINDPM) or the voltage falls below the input voltage limit (VINDPM). The device then reduces the charge current until the input current falls below the input current limit or the input voltage rises above the input voltage limit.

When the charge current is reduced to zero, but the input source is still overloaded, the system voltage starts to drop. Once the system voltage falls below the battery voltage, the device automatically enters the supplement mode where the BATFET turns on and the battery starts discharging so that the system is supported from both the input source and battery.

Figure 10 shows the DPM response with 9-V/1.2-A adapter, 3.2-V battery, 2.8-A charge current and 3.5-V minimum system voltage setting.

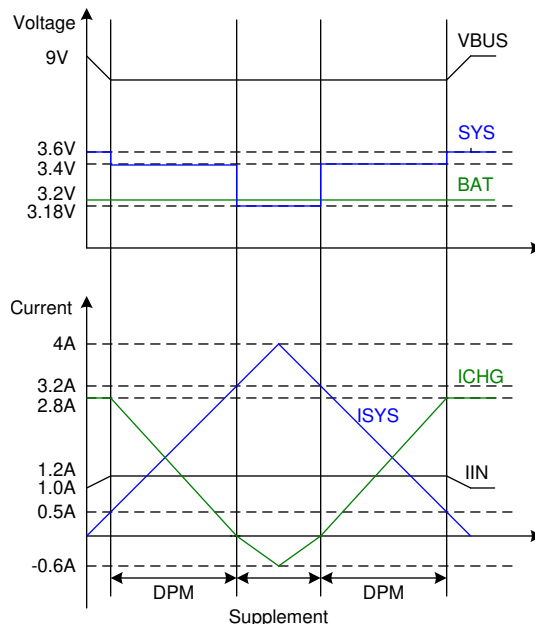

Figure 10. DPM Response

### 9.3.6.3 Supplement Mode

When the system voltage falls below the battery voltage, the BATFET turns on and the BATFET gate is regulated so that the minimum BATFET  $V_{DS}$  stays at 30 mV when the current is low. This prevents oscillation from entering and exiting the supplement mode.

As the discharge current increases, the BATFET gate is regulated with a higher voltage to reduce  $R_{DS(ON)}$  until the BATFET is in full conduction. At this point onwards, the BATFET  $V_{DS}$  linearly increases with discharge current. The BATFET turns off to exit supplement mode when the battery is below battery depletion threshold.

### 9.3.7 Battery Charging Management

The device charges 1-cell Li-Ion battery with up to 3.0-A charge current for high capacity tablet battery. The 19.5-m $\Omega$  BATFET improves charging efficiency and minimizes the voltage drop during discharging.

#### 9.3.7.1 Autonomous Charging Cycle

When battery charging is enabled ( $\overline{CE}$  pin is LOW), the device autonomously completes a charging cycle. The device default charging parameters are listed in Table 4.

Table 4. Charging Parameter Default Setting

DEFAULT MODE	BQ25616/616J
Charging voltage	VSET pin, 4.10 V/4.20 V/4.35 V
Charging current	$I_{CHG}$ pin
Pre-charge current	5% of $I_{CHG}$
Termination current	5% of $I_{CHG}$
Temperature profile	JEITA (BQ25616J), Hot/Cold (BQ25616)
Safety timer	20 hours

A new charge cycle starts when the following conditions are valid:

- Converter starts
- Battery charging is enabled ( $\overline{CE}$  is low)
- No thermistor fault on TS.
- No safety timer fault

The device automatically terminates the charging cycle when the charging current is below the termination threshold, the battery voltage is above the recharge threshold, and the device is not in DPM mode or thermal regulation. When a fully charged battery is discharged below recharge threshold, the device automatically starts a new charging cycle. After the charge is done, toggle  $\overline{CE}$  pin will initiate a new charging cycle. Adapter removal and replug will also restart a charging cycle.

The STAT output indicates the charging status: charging (LOW), charging complete or charge disable (HIGH) or charging fault (blinking).

### 9.3.7.2 Battery Charging Profile

The device charges the battery in five phases: battery short, preconditioning, constant current, constant voltage and top-off trickle charging. At the beginning of a charging cycle, the device checks the battery voltage and regulates current and voltage accordingly.

**Table 5. Charging Current Setting**

$V_{BAT}$	CHARGING CURRENT	DEFAULT SETTING
< 2.2 V	$I_{BAT\_SHORT}$	100 mA
2.2 V to 3 V	$I_{PRECHG}$	5% of ICHG pin setting
> 3 V	$I_{CHG}$	ICHG pin setting

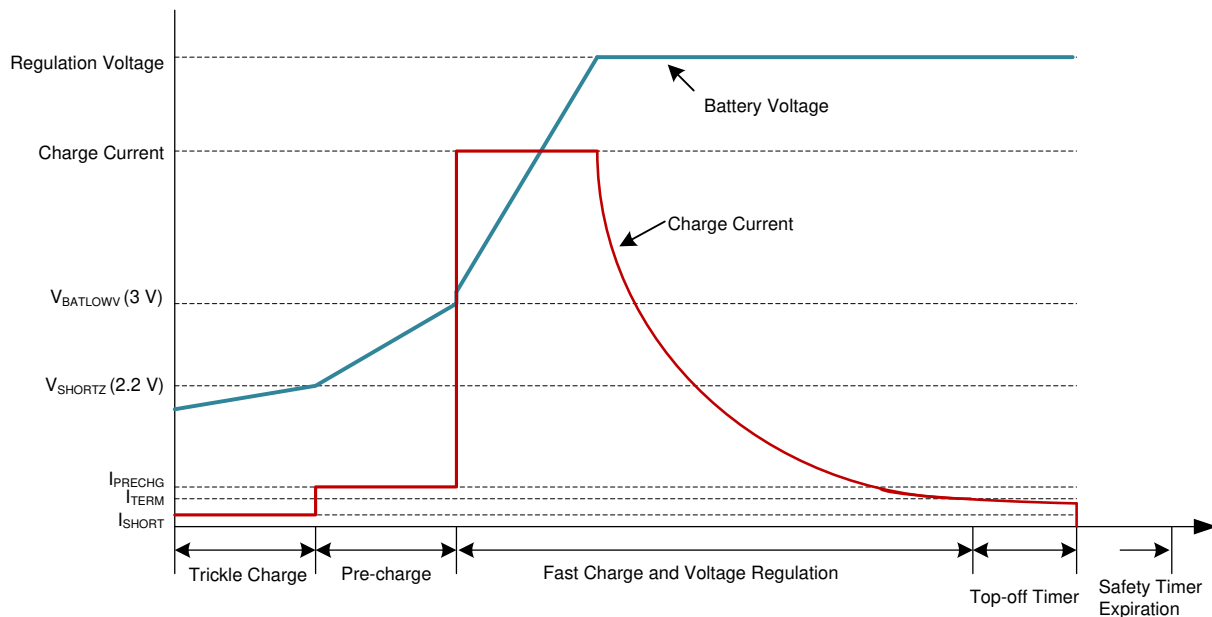

**Figure 11. Battery Charging Profile**

### 9.3.7.3 Charging Termination

The device terminates a charge cycle when the battery voltage is above the recharge threshold, and the current is below termination current. After the charging cycle is completed, the BATFET turns off. The STAT is asserted HIGH to indicate charging done. The converter keeps running to power the system, and BATFET can turn on again to engage [Supplement Mode](#).

If the device is in IINDPM/VINDPM regulation, or thermal regulation, the actual charging current will be less than the termination value. In this case, termination is temporarily disabled.

When termination occurs, STAT pin goes HIGH.

Top-off timer gets reset at one of the following conditions:

1. Charge disable to enable
2. Charger enters termination

### 9.3.7.4 Thermistor Qualification

The device provides a single thermistor input for battery temperature monitoring.

#### 9.3.7.4.1 JEITA Guideline Compliance During Charging Mode (BQ25616J)

To improve the safety of charging Li-ion batteries, the JEITA guideline was released on April 20, 2007. The guideline emphasized the importance of avoiding a high charge current and high charge voltage at certain low and high temperature ranges.

To initiate a charge cycle, the voltage on TS pin, as a percentage of  $V_{REGN}$ , must be within the  $V_{T1\_FALL\%}$  to  $V_{T5\_RISE\%}$  thresholds. If the TS voltage percentage exceeds the T1-T5 range, the controller suspends charging, a TS fault is reported and waits until the battery temperature is within the T1 to T5 range.

At cool temperature (T1-T2), JEITA recommends the charge current to be reduced to 20% of  $I_{CHG}$ . At warm temperature (T3-T5), JEITA recommends charge voltage less than 4.1-V.

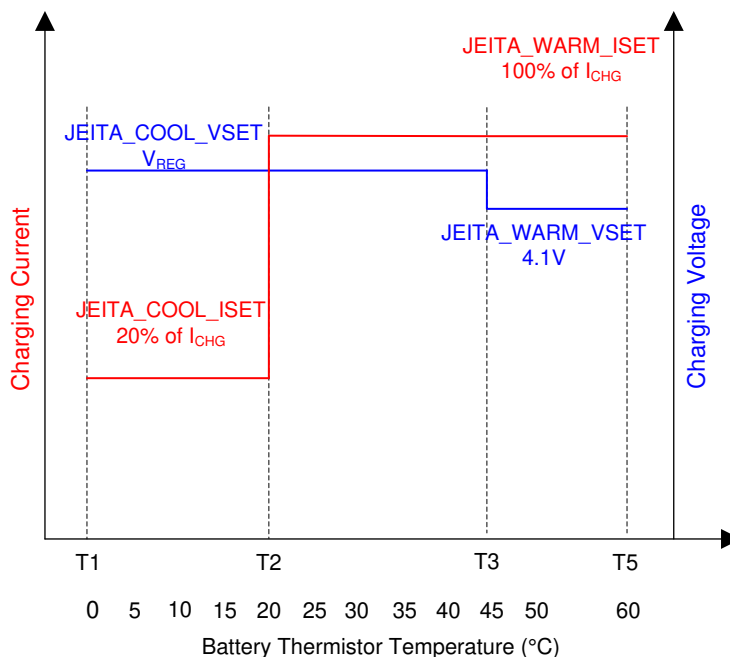
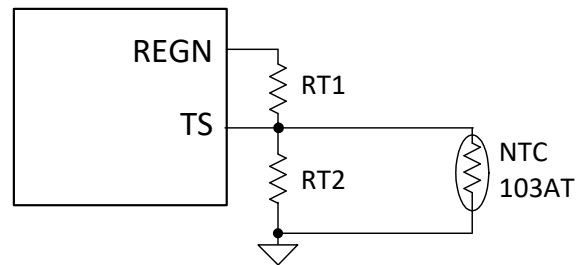

Figure 12. JEITA Profile (BQ25616J)

Equation 3 through Equation 4 describe how to calculate resistor divider values on Ts pin.



**Figure 13. TS Pin Resistor Network**

$$RT1 = \frac{\frac{1}{V_{T1\%}} - 1}{\frac{1}{R_{T2}} + \frac{1}{R_{NTC,T1}}} \quad (3)$$

$$RT2 = \frac{R_{NTC,T1} \times R_{NTC,T5} \times \left( \frac{1}{V_{T5\%}} - \frac{1}{V_{T1\%}} \right)}{R_{NTC,T1} \times \left( \frac{1}{V_{T1\%}} - 1 \right) - R_{NTC,T5} \times \left( \frac{1}{V_{T5\%}} - 1 \right)} \quad (4)$$

In the equations above,  $R_{NTC, T1}$  is NTC thermistor resistance value at temperature T1 and  $R_{NTC, T5}$  is NTC thermistor resistance values at temperature T5. Select 0°C to 60°C range for Li-ion or Li-polymer battery then

- $R_{NTC,T1} = 27.28 \text{ K}\Omega$  (0°C)
- $R_{NTC,T5} = 3.02 \text{ K}\Omega$  (60°C)
- $RT1 = 5.3 \text{ K}\Omega$
- $RT2 = 31.14 \text{ K}\Omega$

#### 9.3.7.4.2 Hot/Cold Temperature Window During Charging Mode (BQ25616)

The BQ25616 provides simple Hot/Cold window T1-T3 with  $V_{REG}$  and  $I_{CHG}$  set on the pins. When  $RT1$  is 5.3 K $\Omega$  and  $RT2$  is 31.14 K $\Omega$ , T1 is 0°C and T3 is 45°C.



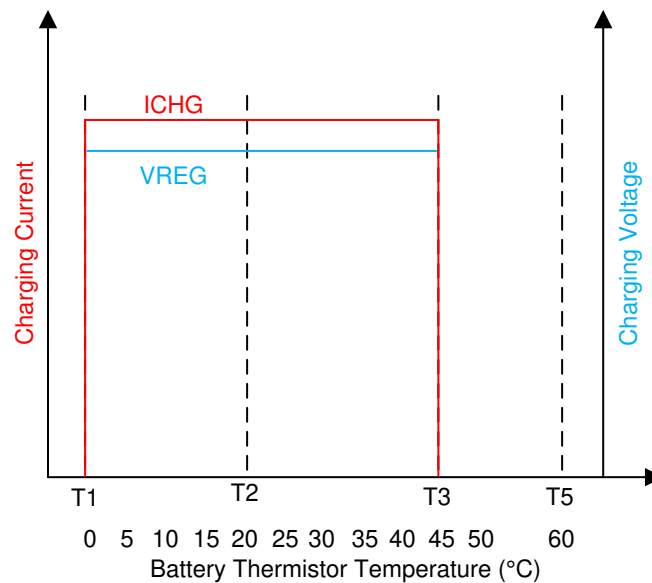

Figure 14. Hot/Cold Profile (BQ25616)

#### 9.3.7.4.3 Boost Mode Thermistor Monitor During Battery Discharge Mode

For battery protection during boost mode, the device monitors the battery temperature to be within the  $V_{BCOLD}$  and  $V_{BHOT}$  thresholds. When  $RT1$  is 5.3 K $\Omega$  and  $RT2$  is 31.14 K $\Omega$ ,  $T_{BCOLD}$  default is -19.5°C and  $T_{BHOT}$  default is 64°C. When temperature is outside of the temperature thresholds, the boost mode is suspended.

#### 9.3.7.5 Charging Safety Timer

The device has a built-in safety timer to prevent extended charging cycle due to abnormal battery conditions. The safety timer is 2 hours when the battery is below  $V_{BATLOWV}$  threshold and 10 hours when the battery is higher than  $V_{BATLOWV}$  threshold. When the safety timer expires, STAT pin is blinking at 1 Hz to report a safety timer expiration fault.

During IINDPDM/VINDPDM regulation, or thermal regulation, the safety timer counts at a half clock rate, because the actual charge current is likely below the setting. For example, if the charger is in input current regulation throughout the whole charging cycle, and the safety time is set to 10 hours, the safety timer will expire in 20 hours.

During faults of BAT\_FAULT, NTC\_FAULT that lead to charging suspend, safety timer is suspended as well. Once the fault goes away, timer resumes. If user stops the current charging cycle, and start again, timer gets reset (toggle CE pin).

### 9.3.8 Status Outputs ( $\overline{PG}$ , STAT)

#### 9.3.8.1 Power Good Indicator ( $\overline{PG}$ Pin)

The  $\overline{PG}$  pin goes LOW to indicate a good input source when:

- $V_{VBUS}$  above  $V_{VBUS\_UVLO}$
- $V_{VBUS}$  above battery (not in sleep)
- $V_{VBUS}$  below  $V_{ACOV}$  threshold
- $V_{VBUS}$  above  $V_{POORSRC}$  (typical 3.8 V) when  $I_{BADSRC}$  (typical 30 mA) current is applied (not a poor source)

- Completed [Input Source Type Detection \(IINDPM Threshold\)](#)

### 9.3.8.2 Charging Status Indicator (STAT)

The device indicates charging state on the open drain STAT pin. The STAT pin can drive LED.

**Table 6. STAT Pin State**

CHARGING STATE	STAT INDICATOR
Charging in progress (including recharge)	LOW
Charging termination (top off timer may be running)	HIGH
Sleep mode, charge disable, boost mode	HIGH
Charge suspend (input over-voltage, TS fault, safety timer fault or system over-voltage)	Blinking at 1 Hz

## 9.3.9 Protections

### 9.3.9.1 Input Current Limit

The device's ILIM pin is to program maximum input current when D+/D– detection identifies an unknown adaptor plugged in. The maximum input current is set by a resistor from ILIM pin to ground as:

$$I_{\text{INDPM}} = \frac{K_{\text{ILIM}}}{R_{\text{ILIM}}} \quad (5)$$

### 9.3.9.2 Voltage and Current Monitoring in Buck Mode

#### 9.3.9.2.1 Input Over-Voltage Protection (ACOV)

This device integrates the functionality of an over-voltage protector. The device can be paired with an external N-channel FET to block input voltages in excess of VBUS rating. For correct operation, connect the cathode of the body diode to VAC node. Back-to-back body diodes between VAC and VBUS are not recommended and will prevent correct operation. The input voltage is sensed via the VAC pin and the ACDRV pin is used to control the external FET gate for protection. The default OVP threshold is 14.2-V. The ACOV circuit has a reaction time of 130-ns (typical) to turn off the external ACFET. Note that turning off the external ACFET will take longer and depends on its gate capacitance. In addition to turning off the external ACFET, an ACOV event will immediately stop converter switching whether in buck or boost mode. The device will automatically resume normal operation once the input voltage drops back below the OVP threshold. During ACOV, REGN LDO is on, and the device doesn't enter HIZ mode.

#### 9.3.9.2.2 System Over-Voltage Protection (SYSOVP)

The charger device clamps the system voltage during a load transient so that the components connected to the system are not damaged due to high voltage.  $V_{\text{SYS\_OVP}}$  threshold is about 300-mV above battery regulation voltage when battery charging is terminated. Upon SYSOVP, converter stops switching immediately to clamp the overshoot. The charger pulls 30-mA  $I_{\text{SYS\_LOAD}}$  discharge current to bring down the system voltage.

### 9.3.9.3 Voltage and Current Monitoring in Boost Mode

#### 9.3.9.3.1 Boost Mode Over-Voltage Protection

When the PMID voltage rises above regulation the target and exceeds  $V_{\text{BST\_OVP}}$ , the device stops switching immediately and the device exits boost mode after the boost mode OVP lasts for 12 ms. Meanwhile, if VAC (and VBUS when shorted to VAC) voltage exceed  $V_{\text{ACOV}}$ , the device will exit boost mode as well.

### 9.3.9.4 Thermal Regulation and Thermal Shutdown

#### 9.3.9.4.1 Thermal Protection in Buck Mode

Besides the battery temperature monitor on TS pin, the device monitors the internal junction temperature  $T_J$  to avoid overheating the chip and limits the IC junction temperature in buck mode. When the internal junction temperature exceeds thermal regulation limit (110°C), the device lowers down the charge current. During thermal regulation, the actual charging current is usually below the programmed battery charging current. Therefore, termination is disabled, the safety timer runs at half the clock rate.

Additionally, the device has thermal shutdown to turn off the converter and BATFET when IC surface temperature exceeds  $T_{SHUT}$  150°C. The BATFET and converter is enabled to recover when IC temperature is 130°C.

#### 9.3.9.4.2 Thermal Protection in Boost Mode

Besides the battery temperature monitor on TS pin, The device monitors the internal junction temperature to provide thermal shutdown during boost mode. When IC junction temperature exceeds  $T_{SHUT}$  150°C, the boost mode is disabled . When IC junction temperature is below 145°C, the host can re-enable boost mode.

### 9.3.9.5 Battery Protection

#### 9.3.9.5.1 Battery Over-Voltage Protection (BATOVP)

The battery over-voltage limit is clamped at 4% above the battery regulation voltage. When battery over-voltage occurs, the charger device immediately stops switching.

#### 9.3.9.5.2 Battery Over-Discharge Protection

When battery is discharged below  $V_{BAT\_DPL\_FALL}$ , the BATFET will latch off to protect battery from over discharge. To recover from over-discharge latch-off, an input source plug-in is required at VAC/VBUS.

#### 9.3.9.5.3 System Over-Current Protection

$I_{SYS\_OCP\_Q4}$  sets battery discharge current limit. Once  $I_{BAT} > I_{SYS\_OCP\_Q4}$ , charger will latch off Q4 and put the device into ship mode. All methods to exit ship mode are valid to bring the part out of Q4 latch off.

## 9.4 Device Functional Modes

The BQ25616/616J is a standalone device and therefore does not have I<sup>2</sup>C functions.

## 10 Application and Implementation

### NOTE

information in the following applications sections is not part of the TI component specification, and TI does not warrant its accuracy or completeness. TI's customers are responsible for determining suitability of components for their purposes. Customers should validate and test their design implementation to confirm system functionality.

### 10.1 Application Information

A typical application consists of the device configured as a stand-alone Power Path management device and a single cell battery charger for Li-Ion and Li-polymer batteries used in a wide range of smart phones and other portable devices. It integrates an input reverse-block FET (RBFET, Q1), high-side switching FET (HSFET, Q2), low-side switching FET (LSFET, Q3), and battery FET (BATFET Q4) between the system and battery. The device also integrates a bootstrap diode for the high-side gate drive.

External ACFET is optional. When external OVP is not used, short the VBUS and VAC pins and allow ACDRV pin to float.

### 10.2 Typical Applications

#### 10.2.1 BQ25616/616J Application without External OVP

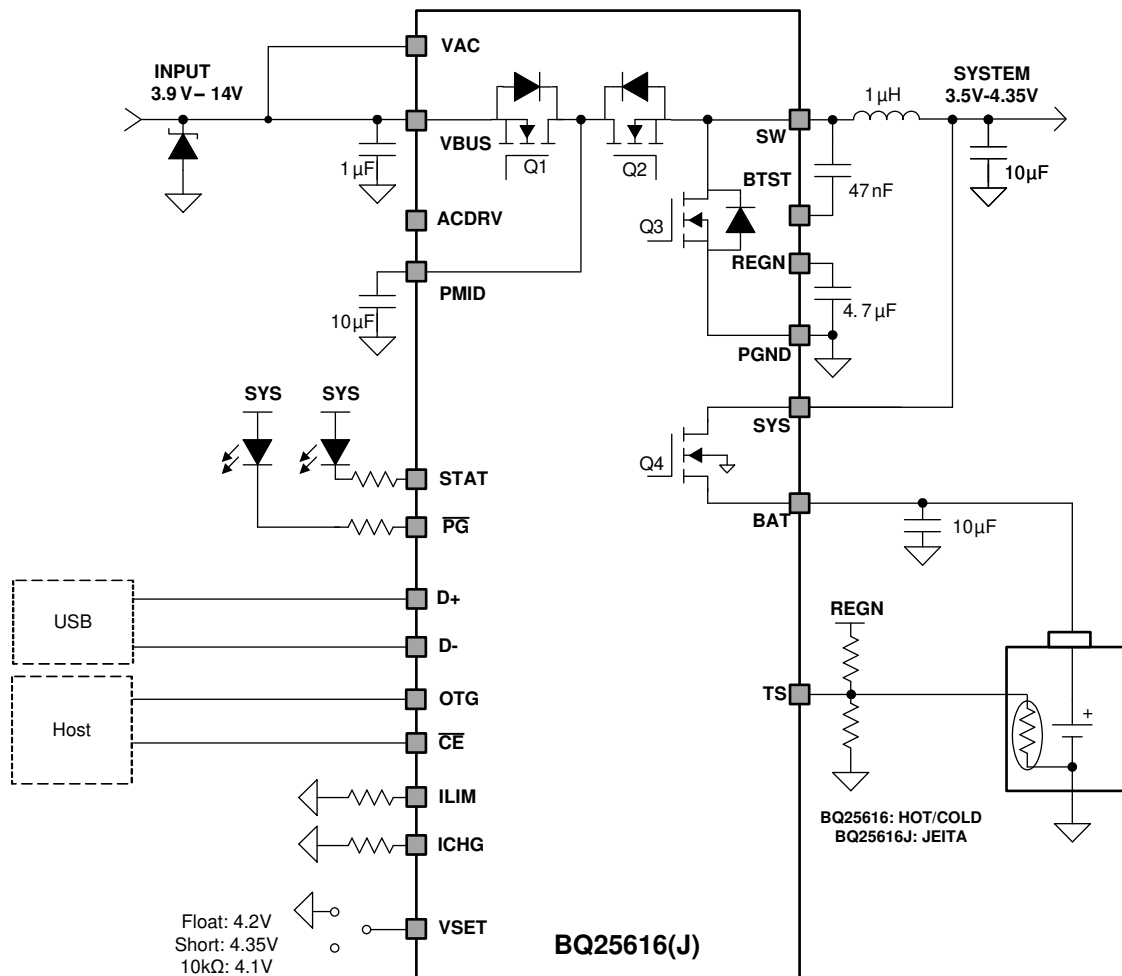

Figure 15. BQ25616/616J Application Diagram without External OVP

## Typical Applications (continued)

### 10.2.1.1 Design Requirements

For this design example, use the parameters shown in the table below.

**Table 7. Design Parameters**

PARAMETER	VALUE
V <sub>VBUS</sub> voltage range	4-V to 13.5-V
Input current limit (D+/D– Detection)	2.4-A
Fast charge current limit (ICHG pin)	ICHG pin
Minimum system voltage	3.5-V
Battery regulation voltage (VSET pin)	4.2-V

### 10.2.1.2 Detailed Design Procedure

#### 10.2.1.2.1 Inductor Selection

The 1.5-MHz switching frequency allows the use of small inductor and capacitor values to maintain an inductor saturation current higher than the charging current (I<sub>CHG</sub>) plus half the ripple current (I<sub>RIPPLE</sub>):

$$I_{SAT} \geq I_{CHG} + (1/2) I_{RIPPLE} \quad (6)$$

The inductor ripple current depends on the input voltage (V<sub>VBUS</sub>), the duty cycle (D = V<sub>BAT</sub>/V<sub>VBUS</sub>), the switching frequency (f<sub>s</sub>) and the inductance (L).

$$I_{RIPPLE} = \frac{V_{IN} \times D \times (1 - D)}{f_s \times L} \quad (7)$$

The maximum inductor ripple current occurs when the duty cycle (D) is 0.5 or approximately 0.5. Usually inductor ripple is designed in the range between 20% and 40% maximum charging current as a trade-off between inductor size and efficiency for a practical design.

#### 10.2.1.2.2 Input Capacitor and Resistor

Design input capacitance to provide enough ripple current rating to absorb input switching ripple current. The worst case RMS ripple current is half of the charging current when duty cycle is 0.5. If the converter does not operate at 50% duty cycle, then the worst case capacitor RMS current I<sub>CIN</sub> occurs where the duty cycle is closest to 50% and can be estimated using .

$$I_{CIN} = I_{CHG} \times \sqrt{D \times (1 - D)} \quad (8)$$

Low ESR ceramic capacitor such as X7R or X5R is preferred for input decoupling capacitor and should be placed to the drain of the high-side MOSFET and source of the low-side MOSFET as close as possible. Voltage rating of the capacitor must be higher than normal input voltage level. A rating of 25-V or higher capacitor is preferred for 12-V input voltage. Capacitance of minimum 10 μF is suggested for typical of 3-A charging current.

During high current output over 700 mA in boost mode, a 10 kΩ pull-down resistor on VBUS is recommended to keep VBUS low in case Q1 RBFET leakage gets high.

#### 10.2.1.2.3 Output Capacitor

Ensure that the output capacitance has enough ripple current rating to absorb the output switching ripple current. shows the output capacitor RMS current I<sub>COUT</sub> calculation.

$$I_{COUT} = \frac{I_{RIPPLE}}{2 \times \sqrt{3}} \approx 0.29 \times I_{RIPPLE} \quad (9)$$

The output capacitor voltage ripple can be calculated as follows:

$$\Delta V_O = \frac{V_{OUT}}{8LCf_s^2} \left( 1 - \frac{V_{OUT}}{V_{IN}} \right) \quad (10)$$

At certain input and output voltage and switching frequency, the voltage ripple can be reduced by increasing the output filter LC.

The charger device has internal loop compensation optimized for >10- $\mu$ F ceramic output capacitance. The preferred ceramic capacitor is 10-V rating, X7R or X5R.

10.2.1.3 Application Curves

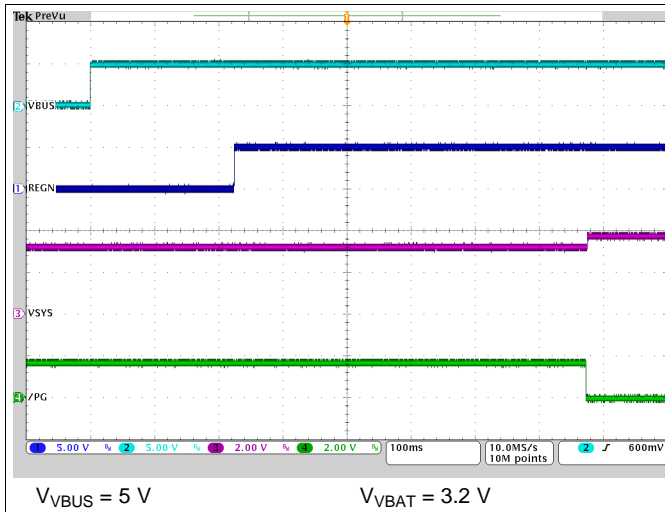

Figure 16. Power-Up with Charge Disabled

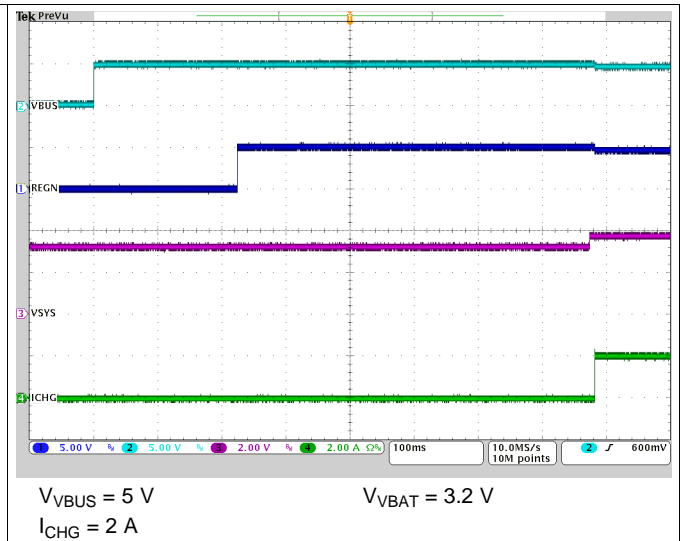

Figure 17. Power-Up with Charge Enabled

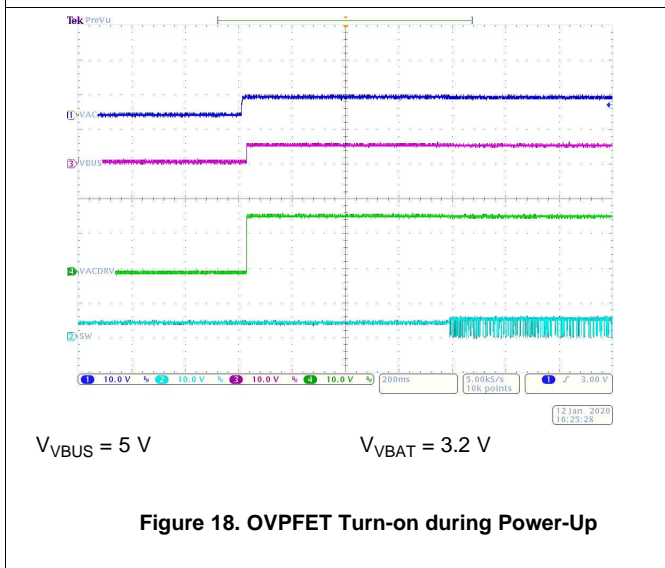

Figure 18. OVPFET Turn-on during Power-Up

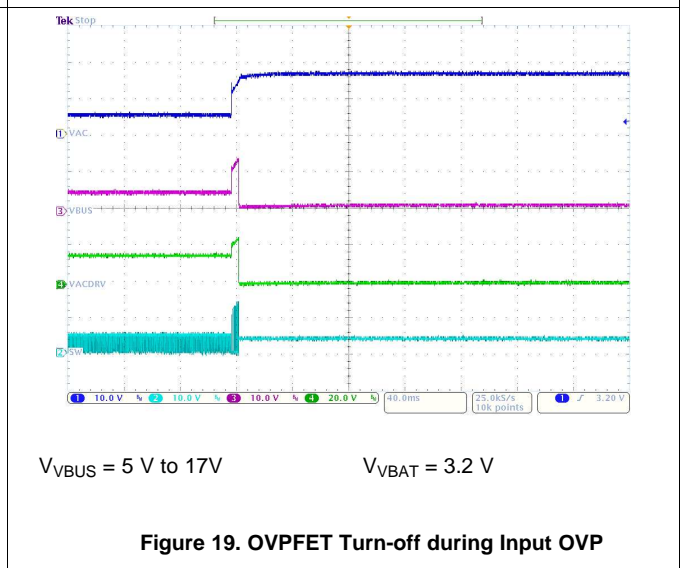
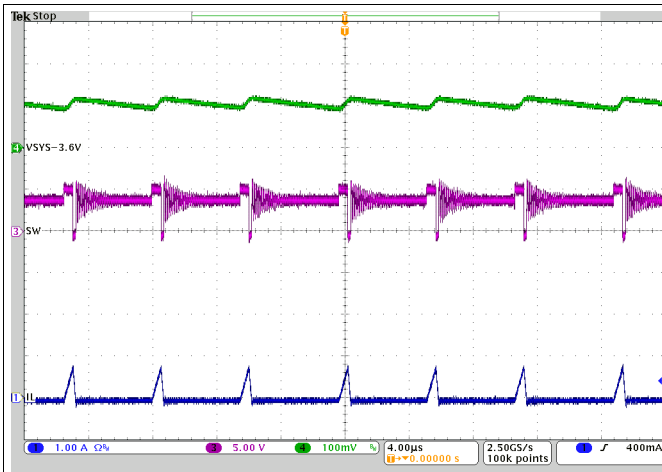

Figure 19. OVPFET Turn-off during Input OVP



$V_{VBUS} = 5\text{ V}$   
 $I_{SYS} = 50\text{ mA}$

Charge Disabled

Figure 20. PFM Switching in Buck Mode

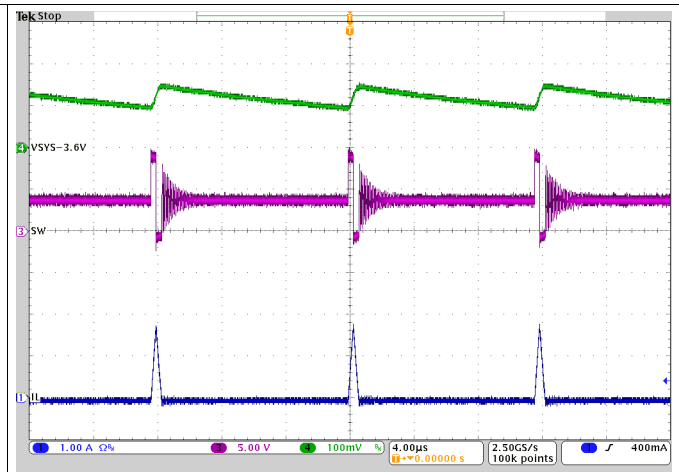

$V_{VBUS} = 9\text{ V}$   
 $I_{SYS} = 50\text{ mA}$

Charge Disabled

Figure 21. PFM Switching in Buck Mode

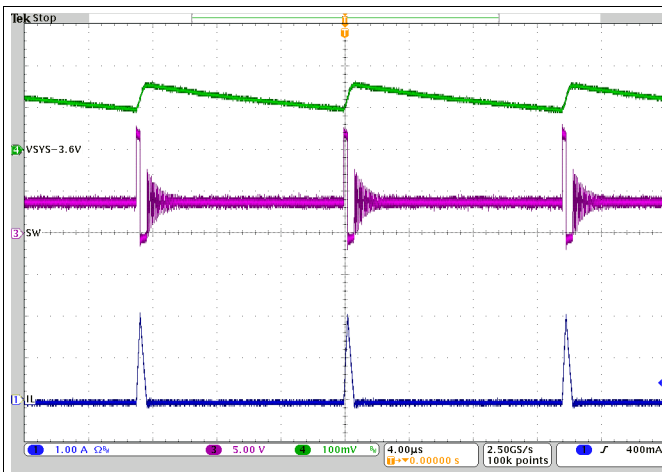

$V_{VBUS} = 12\text{ V}$   
 $I_{SYS} = 50\text{ mA}$

Charge Disabled

Figure 22. PFM Switching in Buck Mode

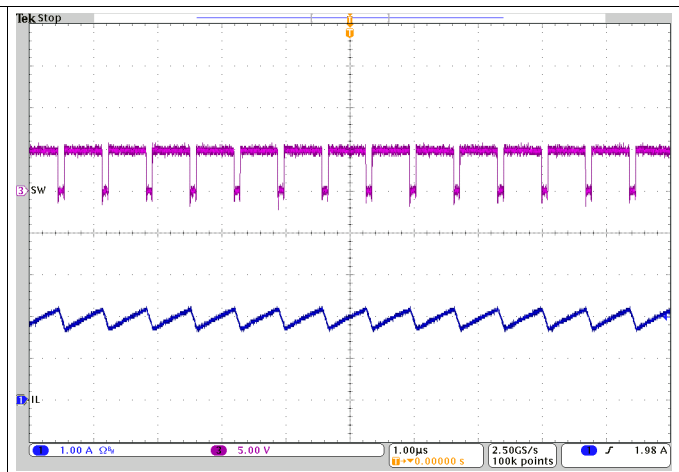

$V_{VBUS} = 5\text{ V}$   
 $I_{CHG} = 2\text{ A}$

$V_{VBAT} = 3.8\text{ V}$

Figure 23. PWM Switching in Buck Mode



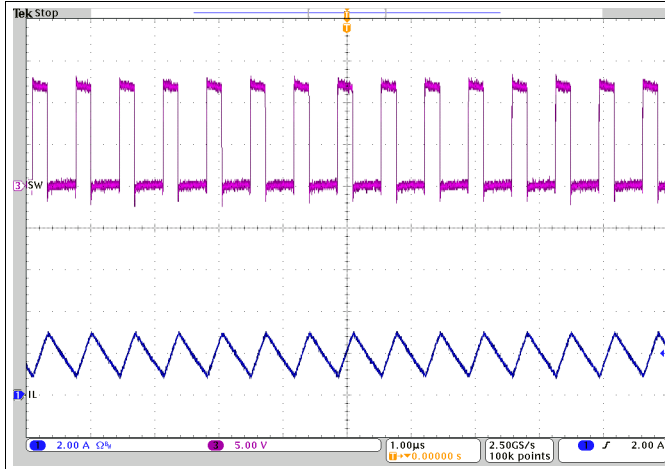

$V_{VBUS} = 12\text{ V}$        $V_{VBAT} = 3.8\text{ V}$   
 $I_{CHG} = 2\text{ A}$

Figure 24. PWM Switching in Buck mode

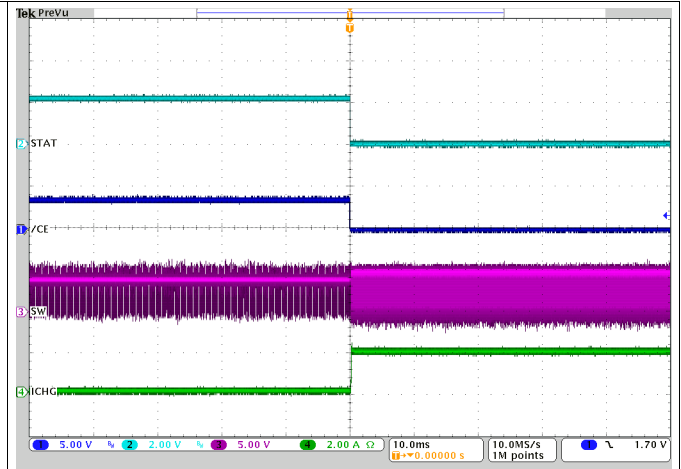

$V_{VBUS} = 5\text{ V}$        $V_{VBAT} = 3.2\text{ V}$   
 $I_{CHG} = 2\text{ A}$

Figure 25. Charge Enable

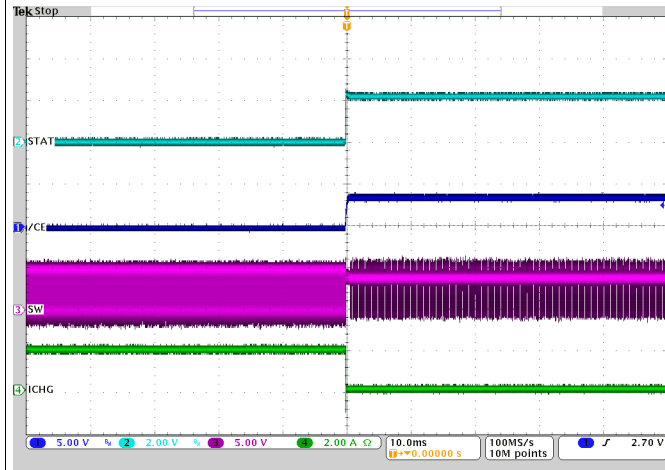

$V_{VBUS} = 5\text{ V}$        $V_{VBAT} = 3.2\text{ V}$   
 $I_{CHG} = 2\text{ A}$

Figure 26. Charge Disable

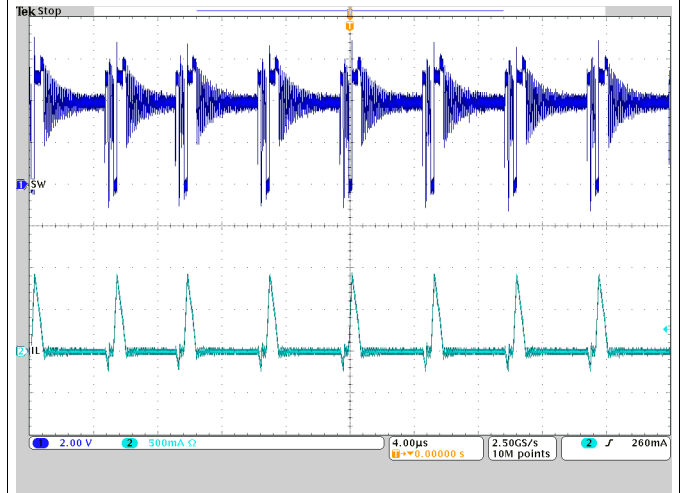

$V_{VBAT} = 4\text{ V}$       PFM Enabled  
 $I_{LOAD} = 50\text{ mA}$

Figure 27. OTG Switching

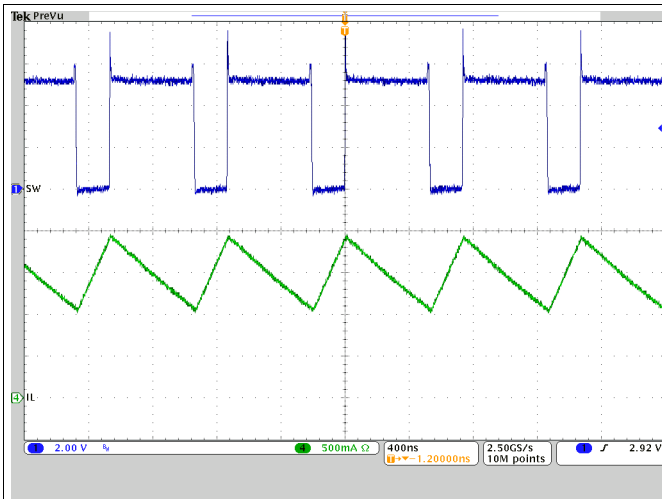

$V_{BAT} = 4\text{ V}$   
 $I_{LOAD} = 1\text{ A}$

PFM Enabled

Figure 28. OTG Switching

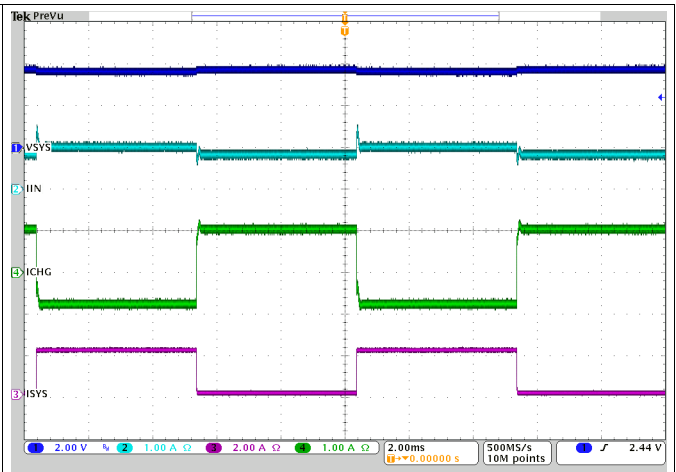

$V_{BUS} = 5\text{ V}$   
 $I_{SYS}$  from 0 A to 2 A  
 $V_{BAT} = 3.7\text{ V}$

$I_{INDPM} = 1\text{ A}$   
 $I_{CHG} = 1\text{ A}$

Figure 29. System Load Transient

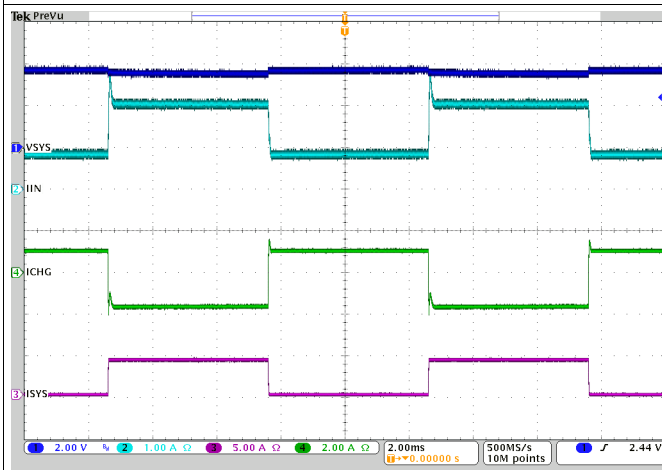

$V_{BUS} = 5\text{ V}$   
 $I_{SYS}$  from 0 A to 4 A  
 $V_{BAT} = 3.7\text{ V}$

$I_{INDPM} = 2\text{ A}$   
 $I_{CHG} = 1\text{ A}$

Figure 30. System Load Transient

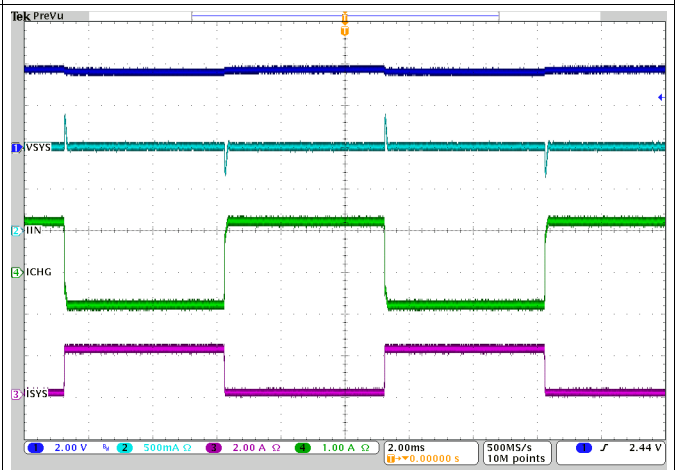

$V_{BUS} = 5\text{ V}$   
 $I_{SYS}$  from 0 A to 2 A  
 $V_{BAT} = 3.7\text{ V}$

$I_{INDPM} = 1\text{ A}$   
 $I_{CHG} = 2\text{ A}$

Figure 31. System Load Transient

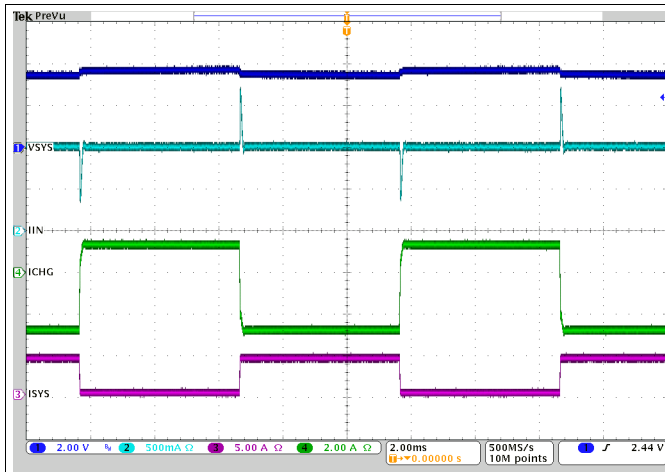

$V_{BUS} = 5\text{ V}$   
 $I_{SYS}$  from 0 A to 4 A  
 $V_{BAT} = 3.7\text{ V}$   
 $I_{INDPM} = 1\text{ A}$   
 $I_{CHG} = 2\text{ A}$

Figure 32. System Load Transient

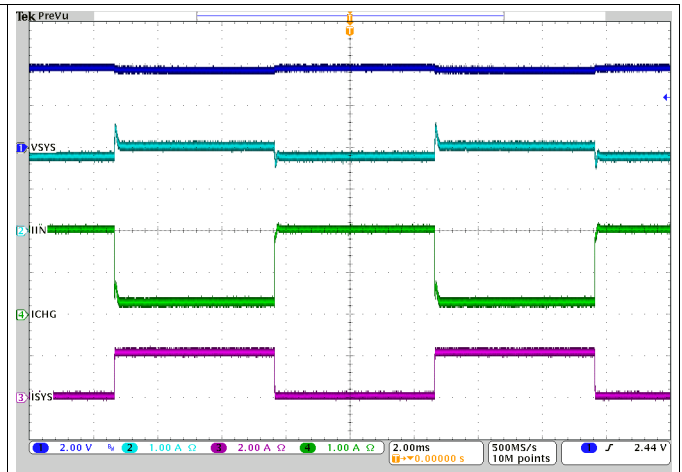

$V_{BUS} = 5\text{ V}$   
 $I_{SYS}$  from 0 A to 2 A  
 $V_{BAT} = 3.7\text{ V}$   
 $I_{INDPM} = 2\text{ A}$   
 $I_{CHG} = 2\text{ A}$

Figure 33. System Load Transient

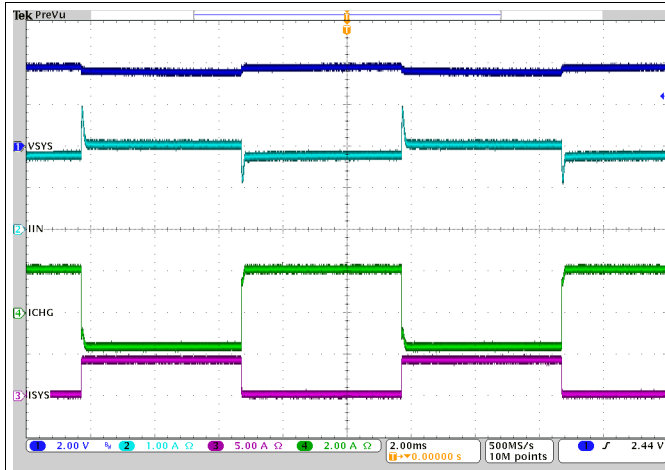

$V_{BUS} = 5\text{ V}$   
 $I_{SYS}$  from 0 A to 4 A  
 $V_{BAT} = 3.7\text{ V}$   
 $I_{INDPM} = 2\text{ A}$   
 $I_{CHG} = 2\text{ A}$

Figure 34. System Load Transient

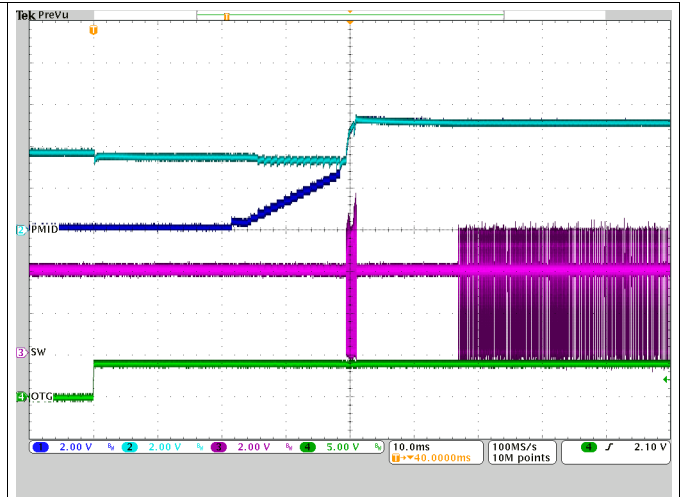

$V_{BAT} = 3.8\text{ V}$   
 $C_{LOAD} = 470\text{ }\mu\text{F}$

Figure 35. OTG Start-Up

**10.2.2 BQ25616/616J Application with External OVP**

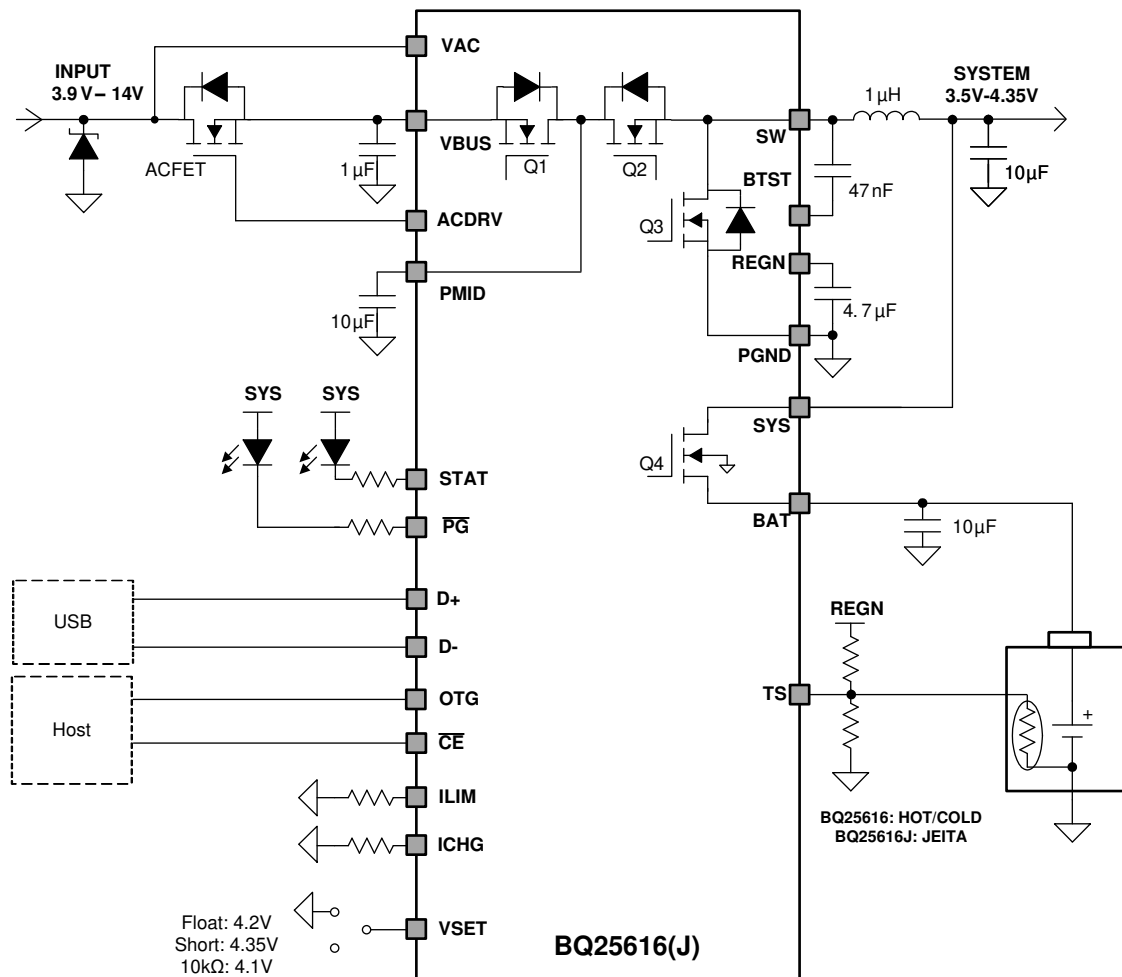

**Figure 36. BQ25616/616J Application Diagram with External OVP**

**10.2.2.1 Design Requirements**

Refer to [Design Requirements](#) for design requirements.

**10.2.2.2 Detailed Design Procedure**

Refer to [Detailed Design Procedure](#) for detailed design procedure.

**10.2.2.3 Application Curves**

Refer to [Application Curves](#) for application curves.

## 11 Power Supply Recommendations

In order to provide an output voltage on SYS, the battery charger requires a power supply between 4-V and 13.5-V input with at least 100-mA current rating connected to VBUS and a single-cell Li-Ion battery with battery voltage greater than  $V_{BAT\_UVLOZ}$  connected to BAT. The source current rating needs to be at least 3-A in order for the buck converter of the charger to provide maximum output power to SYS.

## 12 Layout

### 12.1 Layout Guidelines

The switching node rise and fall times should be minimized for minimum switching loss. Proper layout of the components to minimize high frequency current path loop (see [Figure 37](#)) is important to prevent electrical and magnetic field radiation and high frequency resonant problems. Follow this specific order carefully to achieve the proper layout.

1. Place input capacitor as close as possible to PMID pin and GND pin connections and use shortest copper trace connection or GND plane. Add 1 nF small size (such as 0402 or 0201) decoupling cap for high frequency noise filter and EMI improvement.
2. Place inductor input pin to SW pin as close as possible. Minimize the copper area of this trace to lower electrical and magnetic field radiation but make the trace wide enough to carry the charging current. Do not use multiple layers in parallel for this connection. Minimize parasitic capacitance from this area to any other trace or plane.
3. Put output capacitor near to the inductor and the device. Ground connections need to be tied to the IC ground with a short copper trace connection or GND plane.
4. Route analog ground separately from power ground. Connect analog ground and connect power ground separately. Connect analog ground and power ground together using thermal pad as the single ground connection point. Or using a 0-Ω resistor to tie analog ground to power ground.
5. Use single ground connection to tie charger power ground to charger analog ground. Just beneath the device. Use ground copper pour but avoid power pins to reduce inductive and capacitive noise coupling.
6. Place decoupling capacitors next to the IC pins and make trace connection as short as possible.
7. It is critical that the exposed thermal pad on the backside of the device package be soldered to the PCB ground. Ensure that there are sufficient thermal vias directly under the IC, connecting to the ground plane on the other layers.
8. Ensure that the number and sizes of vias allow enough copper for a given current path.

See the [BQ25618 BMS024 Evaluation Module User's Guide](#) and [BQ25619 BMS025 Evaluation Module EVM User's Guide](#) for the recommended component placement with trace and via locations. For the VQFN information, refer to [Quad Flatpack No-Lead Logic Packages Application Report](#) and [QFN and SON PCB Attachment Application Report](#).

### 12.2 Layout Example

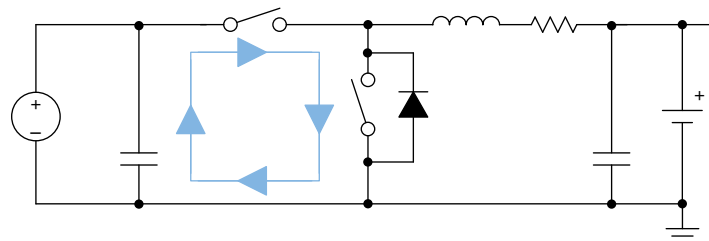

**Figure 37. High Frequency Current Path**

Layout Example (continued)

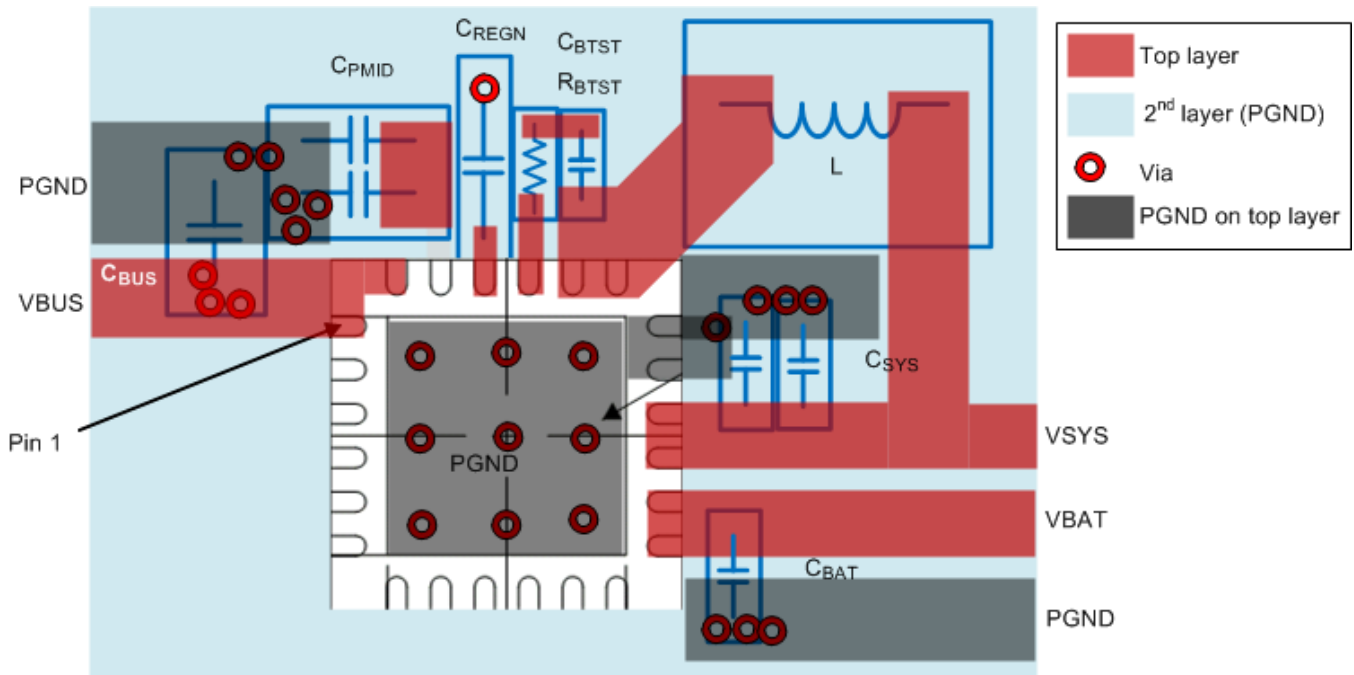

Figure 38. Layout Example

## 13 Device and Documentation Support

### 13.1 Device Support

#### 13.1.1 Third-Party Products Disclaimer

TI'S PUBLICATION OF INFORMATION REGARDING THIRD-PARTY PRODUCTS OR SERVICES DOES NOT CONSTITUTE AN ENDORSEMENT REGARDING THE SUITABILITY OF SUCH PRODUCTS OR SERVICES OR A WARRANTY, REPRESENTATION OR ENDORSEMENT OF SUCH PRODUCTS OR SERVICES, EITHER ALONE OR IN COMBINATION WITH ANY TI PRODUCT OR SERVICE.

### 13.2 Documentation Support

#### 13.2.1 Related Documentation

For related documentation see the following:

- [BQ25619 BMS025 Evaluation Module User's Guide](#)
- [BQ25618 BMS024 Evaluation Module User's Guide](#)

### 13.3 Receiving Notification of Documentation Updates

To receive notification of documentation updates, navigate to the device product folder on ti.com. In the upper right corner, click on *Alert me* to register and receive a weekly digest of any product information that has changed. For change details, review the revision history included in any revised document.

### 13.4 Support Resources

[TI E2E™ support forums](#) are an engineer's go-to source for fast, verified answers and design help — straight from the experts. Search existing answers or ask your own question to get the quick design help you need.

Linked content is provided "AS IS" by the respective contributors. They do not constitute TI specifications and do not necessarily reflect TI's views; see TI's [Terms of Use](#).

### 13.5 Trademarks

E2E is a trademark of Texas Instruments.

### 13.6 Electrostatic Discharge Caution



These devices have limited built-in ESD protection. The leads should be shorted together or the device placed in conductive foam during storage or handling to prevent electrostatic damage to the MOS gates.

### 13.7 Glossary

[SLYZ022](#) — *TI Glossary*.

This glossary lists and explains terms, acronyms, and definitions.

## 14 Mechanical, Packaging, and Orderable Information

The following pages include mechanical, packaging, and orderable information. This information is the most current data available for the designated devices. This data is subject to change without notice and revision of this document. For browser-based versions of this data sheet, refer to the left-hand navigation.



**PACKAGING INFORMATION**

Orderable Device	Status (1)	Package Type	Package Drawing	Pins	Package Qty	Eco Plan (2)	Lead finish/ Ball material (6)	MSL Peak Temp (3)	Op Temp (°C)	Device Marking (4/5)	Samples
BQ25616JRTWR	ACTIVE	WQFN	RTW	24	3000	RoHS & Green	NIPDAU	Level-2-260C-1 YEAR	-40 to 85	BQ 25616J	<a href="#">Samples</a>
BQ25616JRTWT	ACTIVE	WQFN	RTW	24	250	RoHS & Green	NIPDAU	Level-2-260C-1 YEAR	-40 to 85	BQ 25616J	<a href="#">Samples</a>
BQ25616RTWR	ACTIVE	WQFN	RTW	24	3000	RoHS & Green	NIPDAU	Level-1-260C-UNLIM	-40 to 85	BQ25616	<a href="#">Samples</a>
BQ25616RTWT	ACTIVE	WQFN	RTW	24	250	RoHS & Green	NIPDAU	Level-1-260C-UNLIM	-40 to 85	BQ25616	<a href="#">Samples</a>

(1) The marketing status values are defined as follows:

**ACTIVE:** Product device recommended for new designs.

**LIFEBUY:** TI has announced that the device will be discontinued, and a lifetime-buy period is in effect.

**NRND:** Not recommended for new designs. Device is in production to support existing customers, but TI does not recommend using this part in a new design.

**PREVIEW:** Device has been announced but is not in production. Samples may or may not be available.

**OBSOLETE:** TI has discontinued the production of the device.

(2) **RoHS:** TI defines "RoHS" to mean semiconductor products that are compliant with the current EU RoHS requirements for all 10 RoHS substances, including the requirement that RoHS substance do not exceed 0.1% by weight in homogeneous materials. Where designed to be soldered at high temperatures, "RoHS" products are suitable for use in specified lead-free processes. TI may reference these types of products as "Pb-Free".

**RoHS Exempt:** TI defines "RoHS Exempt" to mean products that contain lead but are compliant with EU RoHS pursuant to a specific EU RoHS exemption.

**Green:** TI defines "Green" to mean the content of Chlorine (Cl) and Bromine (Br) based flame retardants meet JS709B low halogen requirements of <=1000ppm threshold. Antimony trioxide based flame retardants must also meet the <=1000ppm threshold requirement.

(3) MSL, Peak Temp. - The Moisture Sensitivity Level rating according to the JEDEC industry standard classifications, and peak solder temperature.

(4) There may be additional marking, which relates to the logo, the lot trace code information, or the environmental category on the device.

(5) Multiple Device Markings will be inside parentheses. Only one Device Marking contained in parentheses and separated by a "-" will appear on a device. If a line is indented then it is a continuation of the previous line and the two combined represent the entire Device Marking for that device.

(6) Lead finish/Ball material - Orderable Devices may have multiple material finish options. Finish options are separated by a vertical ruled line. Lead finish/Ball material values may wrap to two lines if the finish value exceeds the maximum column width.

**Important Information and Disclaimer:**The information provided on this page represents TI's knowledge and belief as of the date that it is provided. TI bases its knowledge and belief on information provided by third parties, and makes no representation or warranty as to the accuracy of such information. Efforts are underway to better integrate information from third parties. TI has taken and

continues to take reasonable steps to provide representative and accurate information but may not have conducted destructive testing or chemical analysis on incoming materials and chemicals. TI and TI suppliers consider certain information to be proprietary, and thus CAS numbers and other limited information may not be available for release.

In no event shall TI's liability arising out of such information exceed the total purchase price of the TI part(s) at issue in this document sold by TI to Customer on an annual basis.

**TAPE AND REEL INFORMATION**

**QUADRANT ASSIGNMENTS FOR PIN 1 ORIENTATION IN TAPE**

\*All dimensions are nominal

Device	Package Type	Package Drawing	Pins	SPQ	Reel Diameter (mm)	Reel Width W1 (mm)	A0 (mm)	B0 (mm)	K0 (mm)	P1 (mm)	W (mm)	Pin1 Quadrant
BQ25616JRTWR	WQFN	RTW	24	3000	330.0	12.4	4.25	4.25	1.15	8.0	12.0	Q2
BQ25616JRTWT	WQFN	RTW	24	250	180.0	12.4	4.25	4.25	1.15	8.0	12.0	Q2
BQ25616RTWR	WQFN	RTW	24	3000	330.0	12.4	4.25	4.25	1.15	8.0	12.0	Q2
BQ25616RTWT	WQFN	RTW	24	250	180.0	12.4	4.25	4.25	1.15	8.0	12.0	Q2

**TAPE AND REEL BOX DIMENSIONS**

\*All dimensions are nominal

Device	Package Type	Package Drawing	Pins	SPQ	Length (mm)	Width (mm)	Height (mm)
BQ25616JRTWR	WQFN	RTW	24	3000	367.0	367.0	35.0
BQ25616JRTWT	WQFN	RTW	24	250	210.0	185.0	35.0
BQ25616RTWR	WQFN	RTW	24	3000	367.0	367.0	35.0
BQ25616RTWT	WQFN	RTW	24	250	210.0	185.0	35.0

RTW (S-PWQFN-N24)

PLASTIC QUAD FLATPACK NO-LEAD

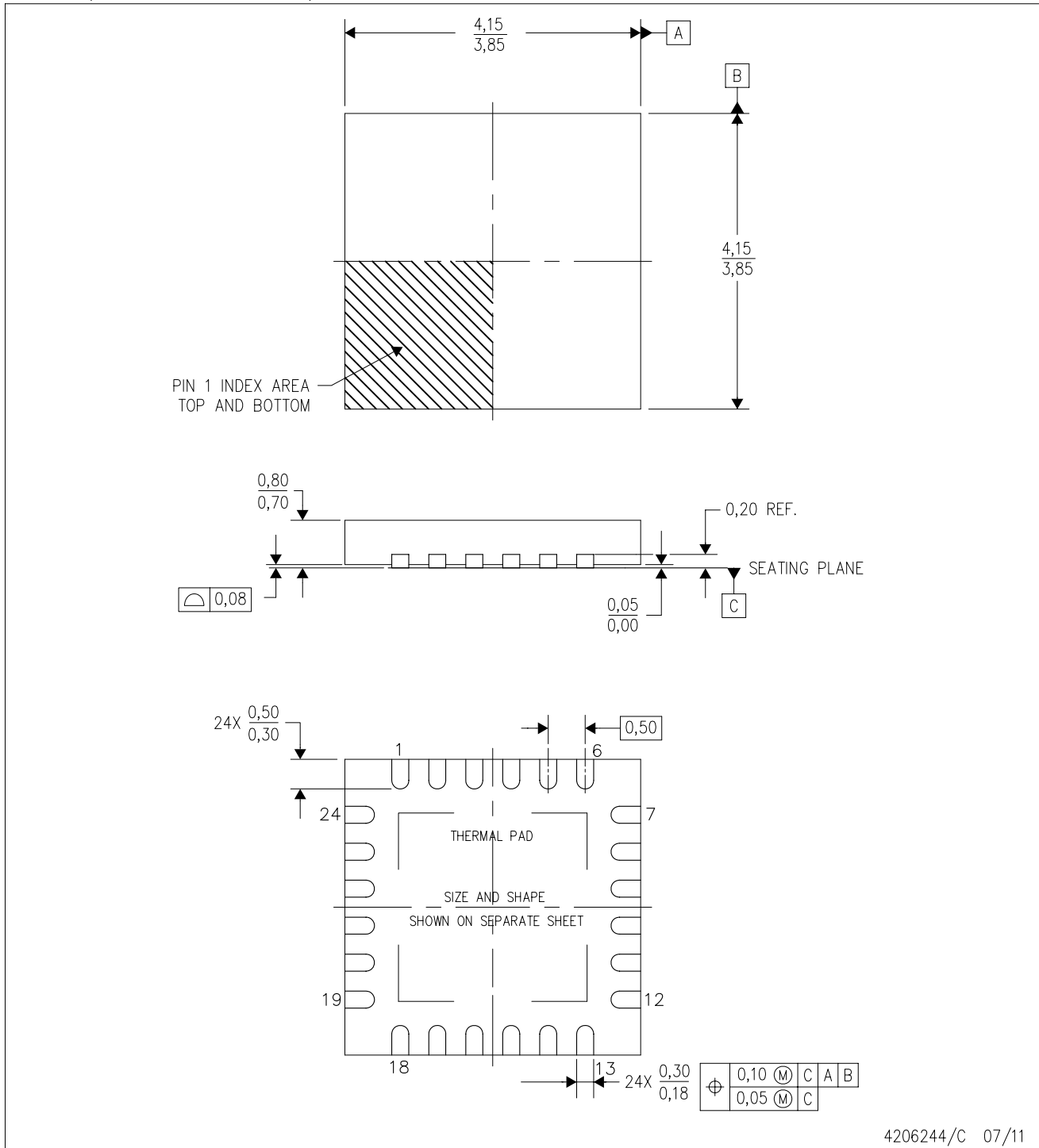

4206244/C 07/11

- NOTES:
- All linear dimensions are in millimeters. Dimensioning and tolerancing per ASME Y14.5M-1994.
  - This drawing is subject to change without notice.
  - Quad Flatpack, No-Leads (QFN) package configuration.
  - The package thermal pad must be soldered to the board for thermal and mechanical performance.
  - See the additional figure in the Product Data Sheet for details regarding the exposed thermal pad features and dimensions.
  - Falls within JEDEC MO-220.

THERMAL INFORMATION

This package incorporates an exposed thermal pad that is designed to be attached directly to an external heatsink. The thermal pad must be soldered directly to the printed circuit board (PCB). After soldering, the PCB can be used as a heatsink. In addition, through the use of thermal vias, the thermal pad can be attached directly to the appropriate copper plane shown in the electrical schematic for the device, or alternatively, can be attached to a special heatsink structure designed into the PCB. This design optimizes the heat transfer from the integrated circuit (IC).

For information on the Quad Flatpack No-Lead (QFN) package and its advantages, refer to Application Report, QFN/SON PCB Attachment, Texas Instruments Literature No. SLUA271. This document is available at [www.ti.com](http://www.ti.com).

The exposed thermal pad dimensions for this package are shown in the following illustration.

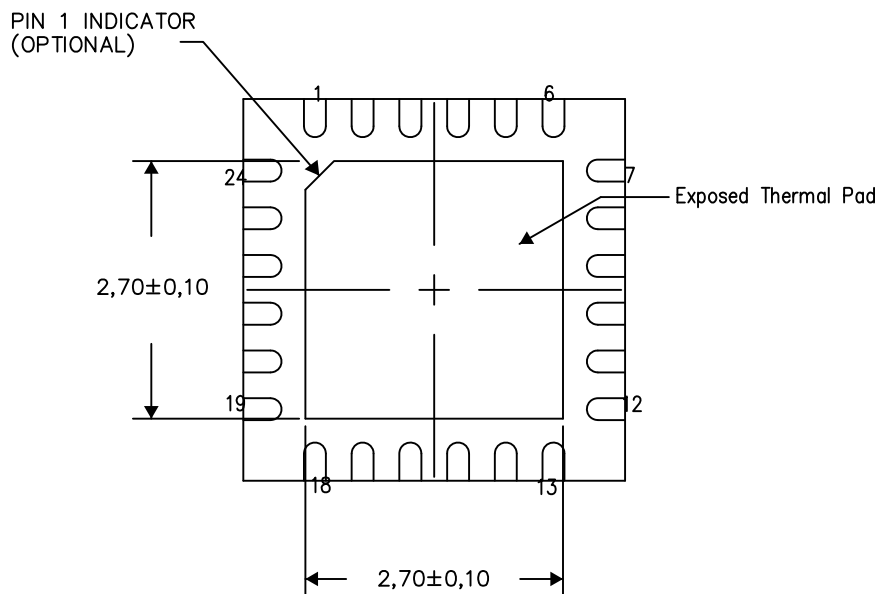

Bottom View

Exposed Thermal Pad Dimensions

4206249-5/P 05/15

NOTES: A. All linear dimensions are in millimeters

RTW (S-PWQFN-N24)

PLASTIC QUAD FLATPACK NO-LEAD

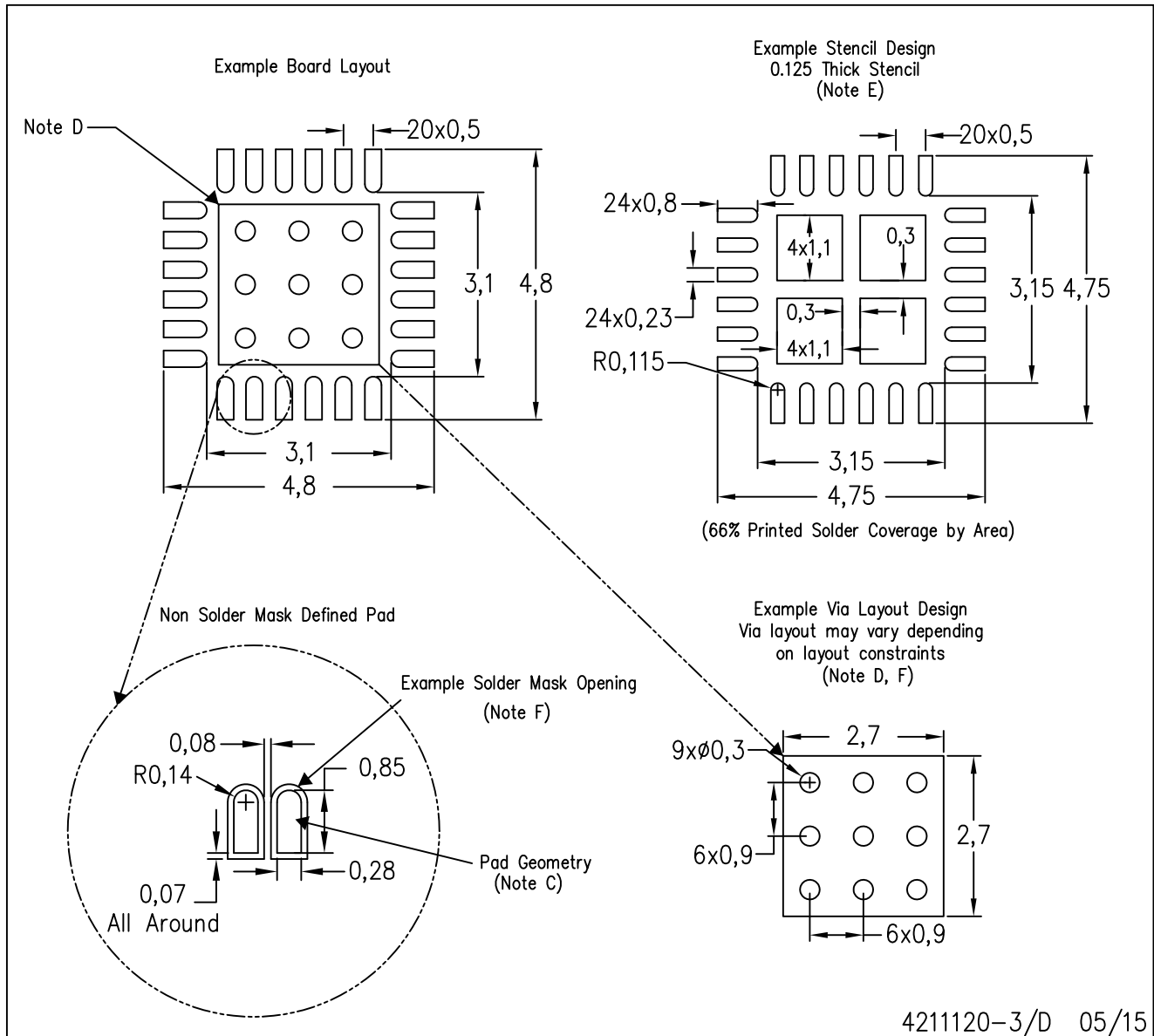

- NOTES:
- All linear dimensions are in millimeters.
  - This drawing is subject to change without notice.
  - Publication IPC-7351 is recommended for alternate designs.
  - This package is designed to be soldered to a thermal pad on the board. Refer to Application Note, Quad Flat-Pack Packages, Texas Instruments Literature No. SLUA271, and also the Product Data Sheets for specific thermal information, via requirements, and recommended board layout. These documents are available at [www.ti.com](http://www.ti.com) <<http://www.ti.com>>.
  - Laser cutting apertures with trapezoidal walls and also rounding corners will offer better paste release. Customers should contact their board assembly site for stencil design recommendations. Refer to IPC 7525 for stencil design considerations.
  - Customers should contact their board fabrication site for recommended solder mask tolerances and via tenting recommendations for vias placed in the thermal pad.

## IMPORTANT NOTICE AND DISCLAIMER

TI PROVIDES TECHNICAL AND RELIABILITY DATA (INCLUDING DATASHEETS), DESIGN RESOURCES (INCLUDING REFERENCE DESIGNS), APPLICATION OR OTHER DESIGN ADVICE, WEB TOOLS, SAFETY INFORMATION, AND OTHER RESOURCES "AS IS" AND WITH ALL FAULTS, AND DISCLAIMS ALL WARRANTIES, EXPRESS AND IMPLIED, INCLUDING WITHOUT LIMITATION ANY IMPLIED WARRANTIES OF MERCHANTABILITY, FITNESS FOR A PARTICULAR PURPOSE OR NON-INFRINGEMENT OF THIRD PARTY INTELLECTUAL PROPERTY RIGHTS.

These resources are intended for skilled developers designing with TI products. You are solely responsible for (1) selecting the appropriate TI products for your application, (2) designing, validating and testing your application, and (3) ensuring your application meets applicable standards, and any other safety, security, or other requirements. These resources are subject to change without notice. TI grants you permission to use these resources only for development of an application that uses the TI products described in the resource. Other reproduction and display of these resources is prohibited. No license is granted to any other TI intellectual property right or to any third party intellectual property right. TI disclaims responsibility for, and you will fully indemnify TI and its representatives against, any claims, damages, costs, losses, and liabilities arising out of your use of these resources.

TI's products are provided subject to TI's Terms of Sale (<https://www.ti.com/legal/termsofsale.html>) or other applicable terms available either on [ti.com](https://www.ti.com) or provided in conjunction with such TI products. TI's provision of these resources does not expand or otherwise alter TI's applicable warranties or warranty disclaimers for TI products.

Mailing Address: Texas Instruments, Post Office Box 655303, Dallas, Texas 75265  
Copyright © 2021, Texas Instruments Incorporated