

# CM3202-00

## DDR VDDQ and VTT Termination Voltage Regulator

### Product Description

The CM3202-00 is a dual-output low noise linear regulator designed to meet SSTL-2 and SSTL-3 specifications for DDR-SDRAM VDDQ supply and termination voltage VTT supply. With integrated power MOSFET's, the CM3202-00 can source up to 2 A of VDDQ continuous current, and source or sink up to 2 A VTT continuous current. The typical dropout voltage for VDDQ is 500 mV at 2 A load current.

The CM3202-00 provides fast response to transient load changes. Load regulation is excellent, from no load to full load. It also has built-in over-current limits and thermal shutdown at 170°C.

The CM3202-00 supports Suspend-To-RAM (STR) and ACPI compliance with shutdown mode which tri-states VTT to minimize quiescent system current.

The CM3202-00 is packaged in an easy-to-use WDFN8. Low thermal resistance allows it to withstand high power dissipation at 85°C ambient. It operates over the industrial ambient temperature range of -40°C to 85°C.

### Features

- Two Linear Regulators
  - ◆ Maximum 2 A Current from VDDQ
  - ◆ Source and Sink Up to 2 A VTT Current
- 1.7 V to 2.8 V Adjustable VDDQ Output Voltage
- 500 mV Typical VDDQ Dropout Voltage at 2 A
- VTT Tracking at 50% of VDDQ
- Excellent Load and Line Regulation, Low Noise
- Fast Transient Response
- Meet JEDEC DDR-I and DDR-II Memory Power Spec.
- Linear Regulator Design Requires No Inductors and Has Low External Component Count
- Integrated Power MOSFETs
- Dual Purpose ADJ/Shutdown Pin
- Built-In Over-Current Limit and Thermal Shutdown for VDDQ and VTT
- Fast Transient Response
- Low Quiescent Current
- These Devices are Pb-Free and are RoHS Compliant

### Applications

- DDR Memory and Active Termination Buses
- Desktop Computers, Servers
- Residential and Enterprise Gateways
- DSL Modems
- Routers and Switchers
- DVD Recorders
- 3D AGP Cards
- LCD TV and STB



ON Semiconductor®

<http://onsemi.com>



WDFN8  
DE SUFFIX  
CASE 511BH

### MARKING DIAGRAM

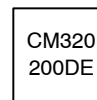

CM320 200DE = CM3202-00DE

### ORDERING INFORMATION

Device	Package	Shipping†
CM3202-00DE	WDFN8 (Pb-Free)	3000/Tape & Reel

†For information on tape and reel specifications, including part orientation and tape sizes, please refer to our Tape and Reel Packaging Specification Brochure, BRD8011/D.

# CM3202-00

## TYPICAL APPLICATION

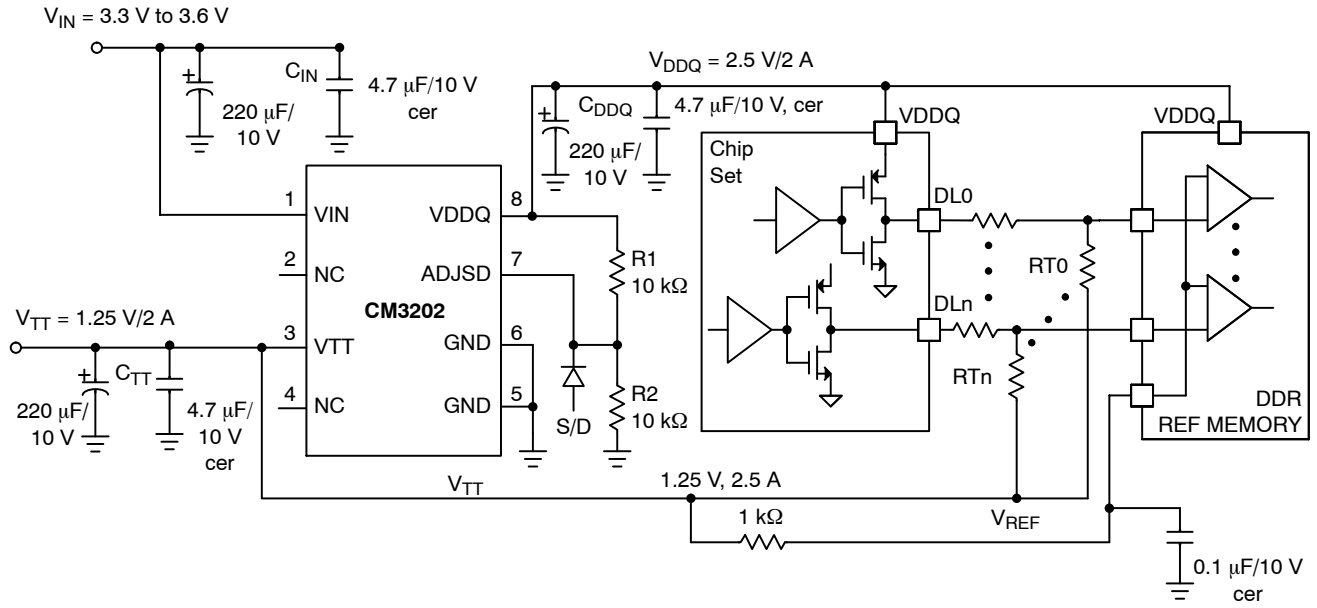

## FUNCTIONAL BLOCK DIAGRAM

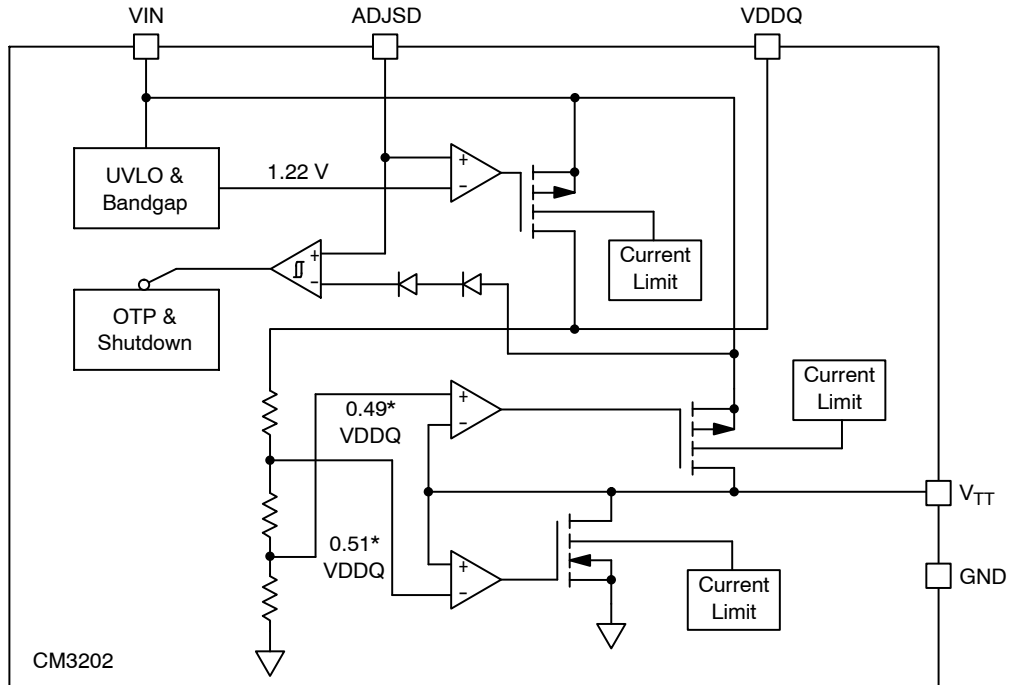

# CM3202-00

## PACKAGE / PINOUT DIAGRAMS

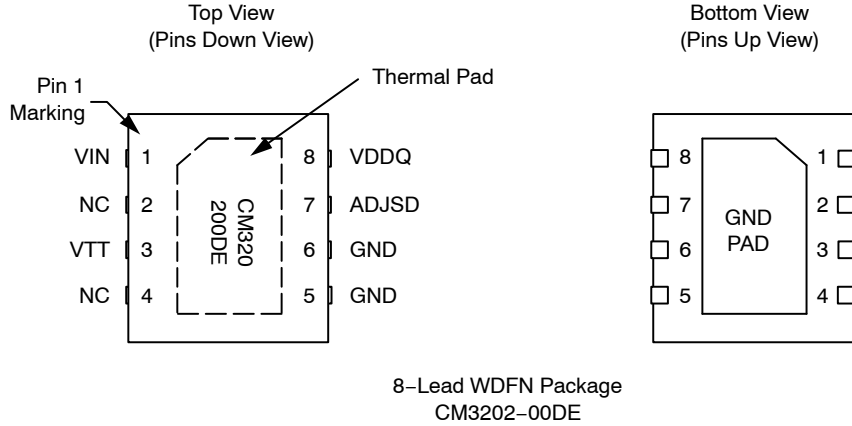

**Table 1. PIN DESCRIPTIONS**

Lead(s)	Name	Description
1	VIN	Input supply voltage pin. Bypass with a 220 $\mu$ F capacitor to GND.
2	NC	Not internally connected. For better heat flow, connect to GND (exposed pad).
3	VTT	$V_{TT}$ regulator output pin, which is preset to 50% of $V_{DDQ}$ .
4	NC	Not internally connected. For better heat flow, connect to GND (exposed pad).
5	GND	Ground pin (analog).
6	GND	Ground pin (power).
7	ADJSD	This pin is for $V_{DDQ}$ output voltage adjustment. It is available as long as $V_{DDQ}$ is enabled. During Manual/Thermal shutdown, it is tightened to GND. The $V_{DDQ}$ output voltage is set using an external resistor divider connected to ADJSD: $V_{DDQ} = 1.25 \text{ V} \times ((R1 + R2) / R2)$ Where R1 is the upper resistor and R2 is the ground-side resistor. In addition, the ADJSD pin functions as a Shutdown pin. When ADJSD voltage is higher than 2.7 V (SHDN_H), the circuit is in Shutdown mode. When ADJSD voltage is below 1.5 V (SHDN_L), both $V_{DDQ}$ and $V_{TT}$ are enabled. A low-leakage Schottky diode in series with ADJSD pin is recommended to avoid interference with the voltage adjustment setting.
8	VDDQ	$V_{DDQ}$ regulator output voltage pin.
Epad	GND	The backside exposed pad which serves as the package heatsink. Must be connected to GND.

# CM3202-00

## SPECIFICATIONS

**Table 2. ABSOLUTE MAXIMUM RATINGS**

Parameter	Rating	Units
V <sub>IN</sub> to GND	[GND – 0.3] to +6.0	V
Pin Voltages V <sub>DDQ</sub> , V <sub>VTT</sub> to GND ADJSD to GND	[GND – 0.3] to +6.0 [GND – 0.3] to +6.0	V
Output Current V <sub>DDQ</sub> / V <sub>VTT</sub> , Continuous (Note 1) V <sub>DDQ</sub> / V <sub>VTT</sub> , Peak V <sub>DDQ</sub> Source + V <sub>VTT</sub> Source	2.0 / ±2.0 2.8 / ±2.8 3	A
Temperature Operating Ambient Operating Junction Storage	–40 to +85 –40 to +170 –40 to +150	°C
Thermal Resistance, R <sub>JA</sub> (Note 2) WDFN8, 3 mm x 3 mm	55	°C / W
Continuous Power Dissipation (Note 2) WDFN8, T <sub>A</sub> = 25°C / 85°C	2.6 / 1.5	W
ESD Protection (HBM)	2000	V
Lead Temperature (Soldering, 10 sec)	300	°C

Stresses exceeding Maximum Ratings may damage the device. Maximum Ratings are stress ratings only. Functional operation above the Recommended Operating Conditions is not implied. Extended exposure to stresses above the Recommended Operating Conditions may affect device reliability.

1. Despite the fact that the device is designed to handle large continuous/peak output currents, it is not capable of handling these under all conditions. Limited by the package thermal resistance, the maximum output current of the device cannot exceed the limit imposed by the maximum power dissipation value.
2. Measured with the package using a 4 in<sup>2</sup> / 2 layers PCB with thermal vias.

**Table 3. STANDARD OPERATING CONDITIONS**

Parameter	Rating	Units
Ambient Operating Temperature Range	–40 to +85	°C
V <sub>DDQ</sub> Regulator DDR–1 Supply Voltage, V <sub>IN</sub> Load Current, Continuous Load Current, Peak (1 s) C <sub>DDQ</sub>	3.1 to 3.6 0 to 2 2.5 220	V A A µF
V <sub>VTT</sub> Regulator DDR–1 Supply Voltage, V <sub>IN</sub> Load Current, Continuous Load Current, Peak (1 s) C <sub>VTT</sub>	3.1 to 3.6 0 to ±2.0 ±2.50 220	V A A µF
V <sub>IN</sub> Supply Voltage Range	3.10 to 3.60	V
V <sub>DDQ</sub> Source + V <sub>VTT</sub> Source Load Current, Continuous Load Current, Peak (1 s)	2.5 3.5	A
Junction Operating Temperature Range	–40 to +150	°C

# CM3202-00

## SPECIFICATIONS (Cont'd)

**Table 4. ELECTRICAL OPERATING CHARACTERISTICS** (Note 1)

Symbol	Parameter	Conditions	Min	Typ	Max	Units
<b>General</b>						
$I_Q$	Quiescent Current	$I_{DDQ} = 0, I_{TT} = 0$		8	15	mA
$I_{SHDN}$	Shutdown Current	$V_{ADJSD} = 3.3 \text{ V}$ (Shutdown)		0.1	0.5	mA
SHDN_H	ADJSD Logic High	(Note 2)	2.7			V
SHDN_L	ADJSD Logic Low				1.50	V
UVLO	Under-Voltage Lockout	Hysteresis = 100 mV	2.40	2.70	2.90	V
$T_{OVER}$	Thermal SHDN Threshold		150	170		°C
$T_{HYS}$	Thermal SHDN Hysteresis			50		°C
TEMPCO	$V_{DDQ}, V_{TT}$ TEMP CO			150		ppm/°C

### VDDQ Regulator

$V_{DDQ \text{ DEF}}$	VDDQ Output Voltage	$I_{DDQ} = 100 \text{ mA}$	2.450	2.500	2.550	V
$V_{DDQ \text{ LOAD}}$	VDDQ Load Regulation	$10 \text{ mA} \leq I_{DDQ} \leq 2 \text{ A}$ (Note 3)		10	25	mV
$V_{DDQ \text{ LINE}}$	VDDQ Line Regulation	$3.1 \text{ V} \leq V_{IN} \leq 3.6 \text{ V}, I_{DDQ} = 0.1 \text{ A}$		5	25	mV
$V_{DROP}$	VDDQ Dropout Voltage	$I_{DDQ} = 2 \text{ A}$ (Note 4)		500		mV
$I_{ADJ}$	ADJSD Bias Current			0.8	3.0	μA
$I_{DDQ \text{ LIM}}$	VDDQ Current Limit		2.0	2.5		A

### VTT Regulator

$V_{TT \text{ DEF}}$	VTT Output Voltage	$I_{TT} = 100 \text{ mA}$	1.225	1.250	1.275	V
$V_{TT \text{ LOAD}}$	VTT Load Regulation	Source, $0 \leq I_{TT} \leq 2 \text{ A}$ (Note 3) Sink, $-2 \text{ A} \leq I_{TT} \leq 0$ (Note 3)	-30	-10	30	mV
$V_{TT \text{ LINE}}$	VTT Line Regulation	$3.1 \text{ V} \leq V_{IN} \leq 3.6 \text{ V}, I_{TT} = 0.1 \text{ A}$		5	15	mV
$I_{TT \text{ LIM}}$	VTT Current Limit	Source / Sink (Note 3)	±2.0	±2.5		A
$I_{VTT \text{ OFF}}$	VTT Shutdown Leakage Current	Thermal Shutdown Enabled			10	μA

- $V_{IN} = 3.3 \text{ V}, V_{DDQ} = 2.50 \text{ V}, V_{TT} = 1.25 \text{ V}$  (default values),  $C_{DDQ} = C_{TT} = 47 \text{ μF}, T_A = 25^\circ\text{C}$  unless otherwise specified.
- The SHDN Logic High value is normally satisfied for full input voltage range by using a low leakage current (below  $1 \text{ μA}$ ). Schottky diode at ADJSD control pin.
- Load and line regulation are measured at constant junction temperature by using pulse testing with a low duty cycle. Changes in output voltage due to heating effects must be taken into account separately. Load and line regulation values are guaranteed up to the maximum power dissipation.
- Dropout voltage is input to output voltage differential at which output voltage has dropped 100 mV from the nominal value obtained at 3.3 V input. It depends on load current and junction temperature.

TYPICAL OPERATING CHARACTERISTICS

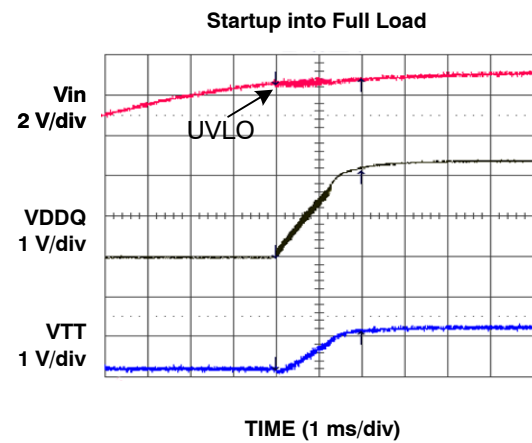
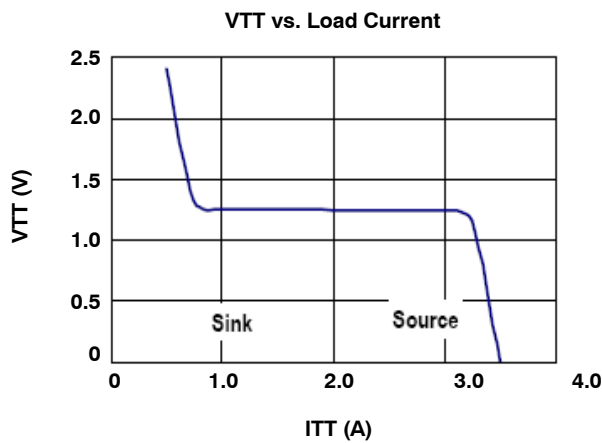
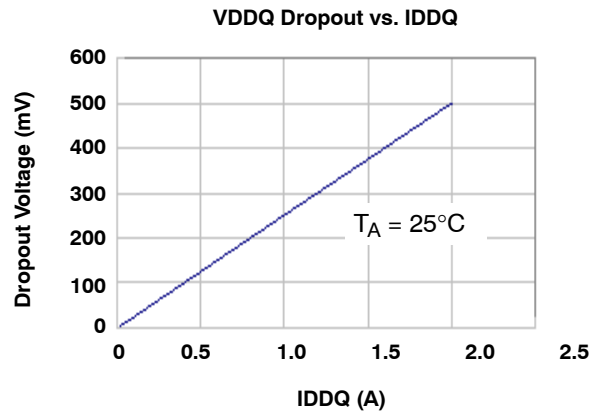
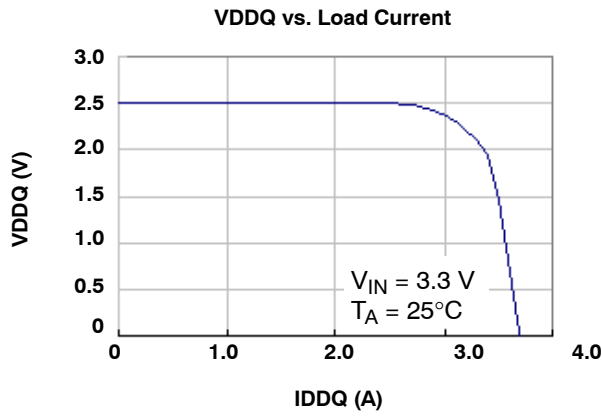
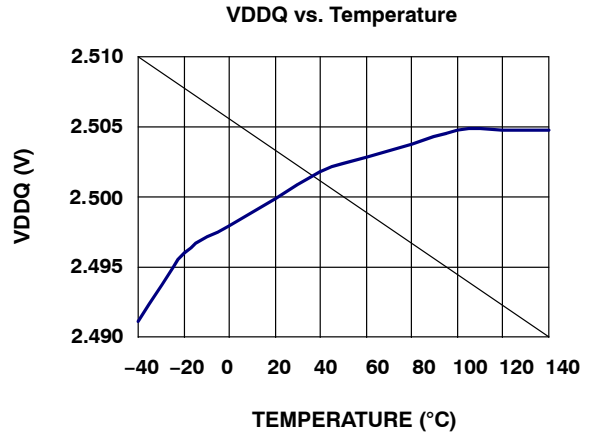
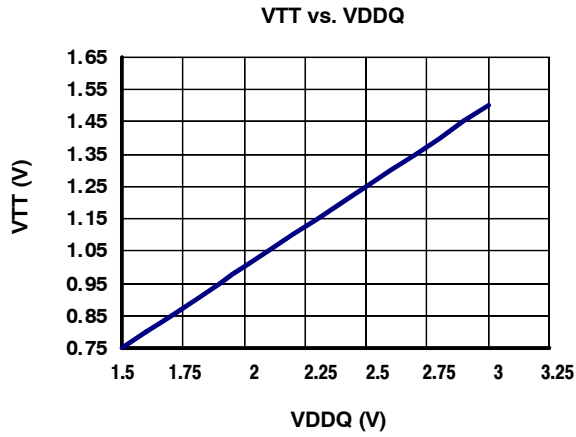

TYPICAL OPERATING CHARACTERISTICS (Cont'd)

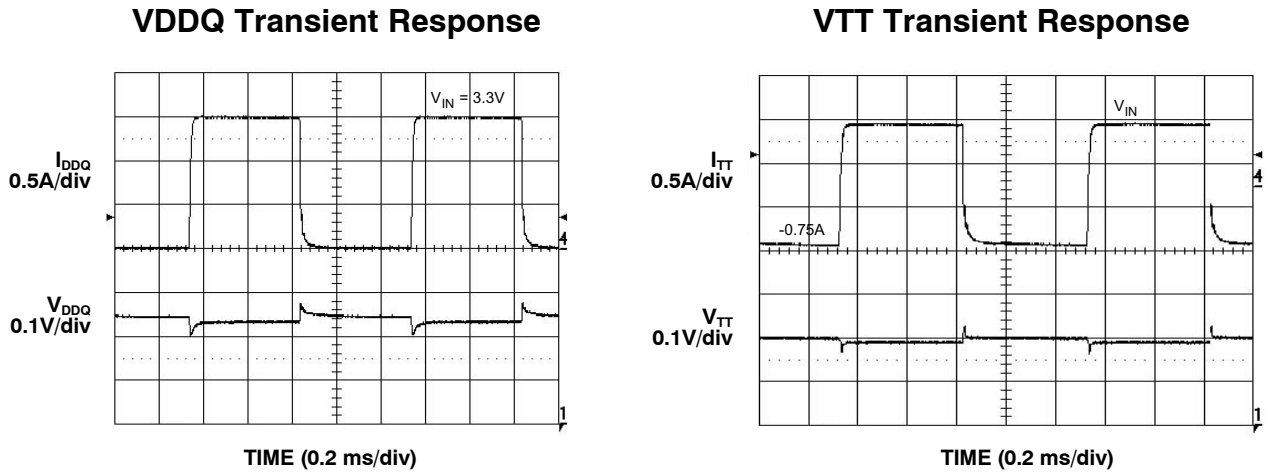

APPLICATION INFORMATION

Powering DDR Memory

Double-Data-Rate (DDR) memory has provided a huge step in performance for personal computers, servers and graphic systems. As is apparent in its name, DDR operates at double the data rate of earlier RAM, with two memory accesses per cycle versus one. DDR SDRAM's transmit data at both the rising and falling edges of the memory bus clock.

DDR's use of Stub Series Terminated Logic (SSTL) topology improves noise immunity and power-supply rejection, while reducing power dissipation. To achieve this performance improvement, DDR requires more complex power management architecture than previous RAM technology.

Unlike the conventional DRAM technology, DDR SDRAM uses differential inputs and a reference voltage for all interface signals. This increases the data bus bandwidth, and lowers the system power consumption. Power consumption is reduced by lower operating voltage, a lower signal voltage swing associated with Stub Series Terminated Logic (SSTL\_2), and by the use of a termination voltage,  $V_{TT}$ . SSTL\_2 is an industry standard defined in JEDEC document JESD8-9. SSTL\_2 maintains high-speed data bus signal integrity by reducing transmission reflections. JEDEC further defines the DDR SDRAM specification in JESD79C.

DDR memory requires three tightly regulated voltages:  $V_{DDQ}$ ,  $V_{TT}$ , and  $V_{REF}$  (see Typical DDR terminations, Class II). In a typical SSTL\_2 receiver, the higher current  $V_{DDQ}$  supply voltage is normally 2.5 V with a tolerance of  $\pm 200$  mV. The active bus termination voltage,  $V_{TT}$ , is half of  $V_{DDQ}$ .  $V_{REF}$  is a reference voltage that tracks half of  $V_{DDQ}$ ,  $\pm 1\%$ , and is compared with the  $V_{TT}$  terminated signal at the receiver.  $V_{TT}$  must be within  $\pm 40$  mV of  $V_{REF}$

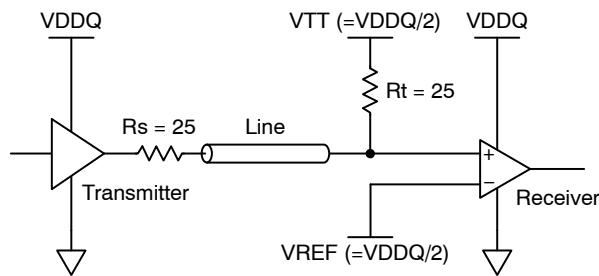

Figure 1. Typical DDR Terminations, Class II

APPLICATION INFORMATION (Cont'd)

The VTT power requirement is proportional to the number of data lines and the resistance of the termination resistor, but does not vary with memory size. In a typical DDR data bus system each data line termination may momentarily consume 16.2 mA to achieve the 405 mV minimum over VTT needed at the receiver:

$$I_{\text{terminator}} = \frac{405 \text{ mV}}{Rt(25 \Omega)} = 16.2 \text{ mA}$$

A typical 64 Mbyte SSTL-2 memory system, with 128 terminated lines, has a worst-case maximum VTT supply current up to ±2.07 A. However, a DDR memory system is dynamic, and the theoretical peak currents only occur for short durations, if they ever occur at all. These high current peaks can be handled by the VTT external capacitor. In a real memory system, the continuous average VTT current level in normal operation is less than ±200 mA.

The VDDQ power supply, in addition to supplying current to the memory banks, could also supply current to controllers and other circuitry. The current level typically stays within a range of 0.5 A to 1 A, with peaks up to 2 A or more, depending on memory size and the computing operations being performed.

The tight tracking requirements and the need for VTT to sink, as well as source, current provide unique challenges for powering DDR SDRAM.

**CM3202-00 Regulator**

The CM3202-00 dual output linear regulator provides all of the power requirements of DDR memory by combining two linear regulators into a single TDFN-8 package. VDDQ regulator can supply up to 2 A current, and the two-quadrant VTT termination regulator has current sink and source capability to ±2 A. The VDDQ linear regulator uses a PMOS pass element for a very low dropout voltage, typically 500 mV at a 2 A output. The output voltage of VDDQ can be set by an external voltage divider. The use of regulators for both the upper and lower side of the VDDQ output allows a fast transient response to any change of the load, from high current to low current or inversely. The second output, VTT, is regulated at VDDQ/2 by an internal resistor divider. Same as VDDQ, VTT has the same fast transient response to load change in both directions. The VTT regulator can source, as well as sink, up to 2 A current. The CM3202-00 is designed for optimal operation from a nominal 3.3 VDC bus, but can work with VIN as high as 5 V. When operating at higher VIN voltages, attention must be given to the increased package power dissipation and proportionally increased heat generation.

VREF is typically routed to inputs with high impedance, such as a comparator, with little current draw. An adequate VREF can be created with a simple voltage divider of precision, matched resistors from VDDQ to ground. A small ceramic bypass capacitor can also be added for improved noise performance.

**Input and Output Capacitors**

The CM3202-00 requires that at least a 220 µF electrolytic capacitor be located near the VIN pin for stability and to maintain the input bus voltage during load transients. An additional 4.7 µF ceramic capacitor between the VIN and the GND, located as close as possible to those pins, is recommended to ensure stability.

At a minimum of a 220 µF electrolytic capacitor is recommended for the VDDQ output. An additional 4.7 µF ceramic capacitor between the VDDQ and GND, located very close to those pins, is recommended.

At a minimum of a 220 µF electrolytic capacitor is recommended for the VTT output. This capacitor should have low ESR to achieve best output transient response. SP or OSCON capacitors provide low ESR at high frequency, and thus are a good choice. In addition, place a 4.7 µF ceramic capacitor between the VTT pin and GND, located very close to those pins. The total ESR must be low enough to keep the transient within the VTT window of 40 mV during the transition for source to sink. An average current step of ±0.5 A requires:

$$ESR < \frac{40 \text{ mV}}{1 \text{ A}} = 40 \text{ m}\Omega$$

Both outputs will remain stable and in regulation even during light or no load conditions.



APPLICATION INFORMATION (Cont'd)

**Adjusting VDDQ Output Voltage**

The CM3202-00 internal bandgap reference is set at 1.25 V. The V<sub>DDQ</sub> voltage is adjustable by using a resistor divider, R1 and R2:

$$V_{DDQ} = V_{ADJ} \times \frac{R1 + R2}{R2}$$

where V<sub>ADJ</sub> = 1.25 V. For best regulator stability, we recommend that R<sub>1</sub> and R<sub>2</sub> not exceed 10 kΩ each.

**Shutdown**

ADJSD also serves as a shutdown pin. When this is pulled high (SHDN\_H), both the VDDQ and the VTT outputs tri-state and could sink/source less than 10 μA. During shutdown, the quiescent current is reduced to less than 0.5 mA, independent of output load.

It is recommended that a low leakage Schottky diode be placed between the ADJSD Pin and an external shutdown signal to prevent interference with the ADJ pin's normal operation. When the diode anode is pulled low, or left open, the CM3202-00 is again enabled.

**Current Limit, Foldback and Over-temperature Protection**

The CM3202-00 features internal current limiting with thermal protection. During normal operation, V<sub>DDQ</sub> limits the output current to approximately 2 A and V<sub>TT</sub> limits the output current to approximately ±2 A. When V<sub>TT</sub> is current limiting into a hard short circuit, the output current folds back to a lower level, about 1 A, until the over-current condition ends. While current limiting is designed to prevent gross device failure, care should be taken not to exceed the power dissipation ratings of the package. If the junction temperature of the device exceeds 170°C (typical), the thermal protection circuitry triggers and tri-states both VDDQ and VTT outputs. Once the junction temperature has cooled to below about 120°C the CM3202-00 returns to normal operation.

**Thermal Considerations**

**Typical Thermal Characteristics**

The overall junction to ambient thermal resistance (θ<sub>JA</sub>) for device power dissipation (P<sub>D</sub>) primarily consists of two paths in the series. The first path is the junction to the case (θ<sub>JC</sub>) which is defined by the package style and the second path is case to ambient (θ<sub>CA</sub>) thermal resistance which is dependent on board layout. The final operating junction temperature for any condition can be estimated by the following thermal equation:

$$\begin{aligned} T_{JUNC} &= T_{AMB} + P_D \times (\theta_{JC}) + P_D \times (\theta_{CA}) \\ &= T_{AMB} + P_D \times (\theta_{CA}) \end{aligned}$$

When a CM3202-00 using WDFN8 package is mounted on a double-sided printed circuit board with four square inches of copper allocated for "heat spreading," the θ<sub>JA</sub> is approximately 55°C/W. Based on the over temperature limit of 170°C with an ambient temperature of 85°C, the available power of the package will be:

$$P_D = \frac{170^\circ C - 85^\circ C}{55^\circ C/W} = 1.5 W$$

APPLICATION INFORMATION (Cont'd)

**PCB Layout Considerations**

The CM3202-00 has a heat spreader attached to the bottom of the WDFN8 package in order for the heat to be transferred more easily from the package to the PCB. The heat spreader is a copper pad of dimensions just smaller than the package itself. By positioning the matching pad on the PCB top layer to connect to the spreader during the manufacturing, the heat will be transferred between the two pads. See the Thermal Layout, the CM3202-00 shows the recommended PCB layout. Please be noted that there are four vias on either side to allow the heat to dissipate into the ground and power planes on the inner layers of the PCB. Vias can be placed underneath the chip, but this can be resulted in blocking of the solder. The ground and power planes need to be at least 2 square inches of copper by the vias. It also helps dissipation if the chip is positioned away from the edge of the PCB, and not near other heat-dissipating devices. A good thermal link from the PCB pad to the rest of the PCB will assure the best heat transfer from the CM3202-00 to ambient,  $\theta_{JA}$ , of approximately 55°C/W.

Top View

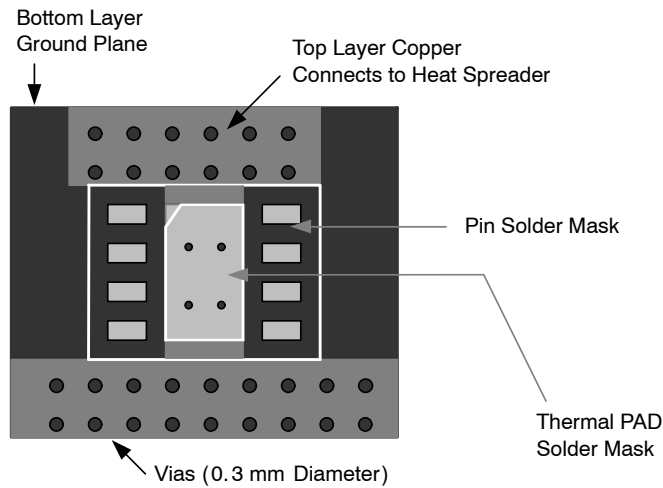

Figure 2. Thermal Layout for WDFN8 Package

# MECHANICAL CASE OUTLINE

## PACKAGE DIMENSIONS

ON Semiconductor®



SCALE 2:1

WDFN8 3x3, 0.65P  
CASE 511BH-01  
ISSUE O

DATE 21 JUL 2010

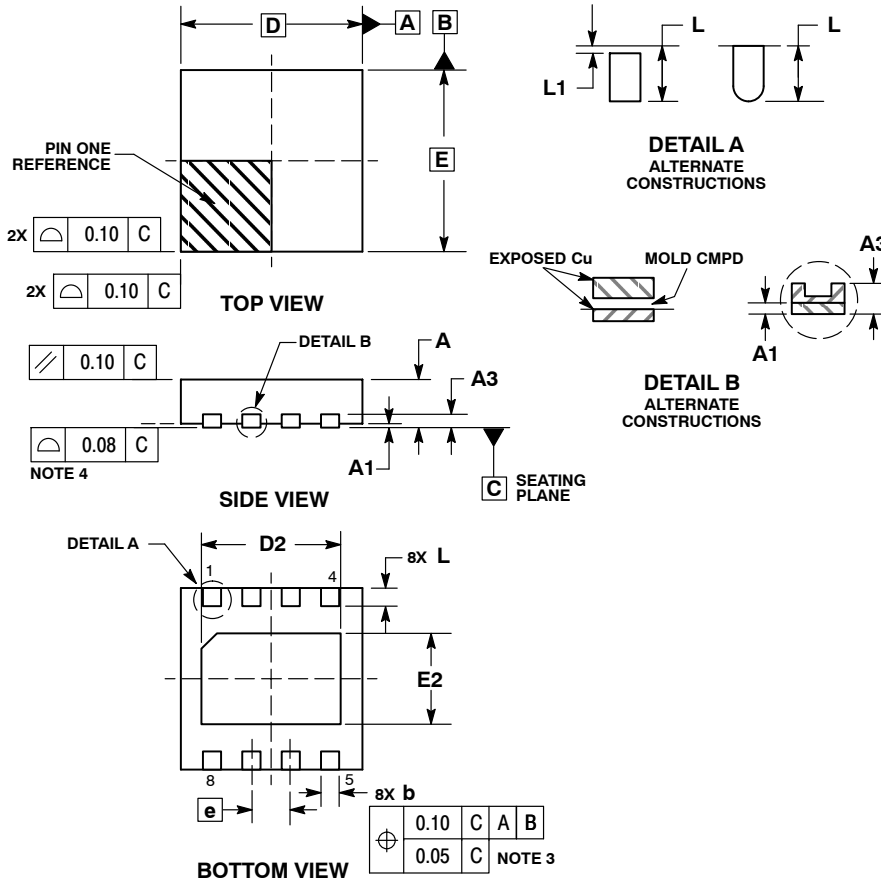

- NOTES:
1. DIMENSIONING AND TOLERANCING PER ASME Y14.5M, 1994.
  2. CONTROLLING DIMENSION: MILLIMETERS.
  3. DIMENSION b APPLIES TO PLATED TERMINAL AND IS MEASURED BETWEEN 0.15 AND 0.30 MM FROM TERMINAL TIP.
  4. COPLANARITY APPLIES TO THE EXPOSED PAD AS WELL AS THE TERMINALS.

### RECOMMENDED SOLDERING FOOTPRINT\*

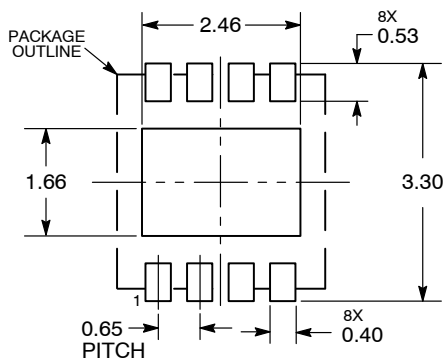

DIMENSIONS: MILLIMETERS

\*For additional information on our Pb-Free strategy and soldering details, please download the ON Semiconductor Soldering and Mounting Techniques Reference Manual, SOLDERRM/D.

<b>DOCUMENT NUMBER:</b>	<b>98AON49350E</b>	Electronic versions are uncontrolled except when accessed directly from the Document Repository. Printed versions are uncontrolled except when stamped "CONTROLLED COPY" in red.
<b>DESCRIPTION:</b>	<b>WDFN8, 3X3, 0.65P</b>	<b>PAGE 1 OF 1</b>

ON Semiconductor and are trademarks of Semiconductor Components Industries, LLC dba ON Semiconductor or its subsidiaries in the United States and/or other countries. ON Semiconductor reserves the right to make changes without further notice to any products herein. ON Semiconductor makes no warranty, representation or guarantee regarding the suitability of its products for any particular purpose, nor does ON Semiconductor assume any liability arising out of the application or use of any product or circuit, and specifically disclaims any and all liability, including without limitation special, consequential or incidental damages. ON Semiconductor does not convey any license under its patent rights nor the rights of others.

ON Semiconductor and  are trademarks of Semiconductor Components Industries, LLC dba ON Semiconductor or its subsidiaries in the United States and/or other countries. ON Semiconductor owns the rights to a number of patents, trademarks, copyrights, trade secrets, and other intellectual property. A listing of ON Semiconductor's product/patent coverage may be accessed at [www.onsemi.com/site/pdf/Patent-Marking.pdf](http://www.onsemi.com/site/pdf/Patent-Marking.pdf). ON Semiconductor reserves the right to make changes without further notice to any products herein. ON Semiconductor makes no warranty, representation or guarantee regarding the suitability of its products for any particular purpose, nor does ON Semiconductor assume any liability arising out of the application or use of any product or circuit, and specifically disclaims any and all liability, including without limitation special, consequential or incidental damages. Buyer is responsible for its products and applications using ON Semiconductor products, including compliance with all laws, regulations and safety requirements or standards, regardless of any support or applications information provided by ON Semiconductor. "Typical" parameters which may be provided in ON Semiconductor data sheets and/or specifications can and do vary in different applications and actual performance may vary over time. All operating parameters, including "Typicals" must be validated for each customer application by customer's technical experts. ON Semiconductor does not convey any license under its patent rights nor the rights of others. ON Semiconductor products are not designed, intended, or authorized for use as a critical component in life support systems or any FDA Class 3 medical devices or medical devices with a same or similar classification in a foreign jurisdiction or any devices intended for implantation in the human body. Should Buyer purchase or use ON Semiconductor products for any such unintended or unauthorized application, Buyer shall indemnify and hold ON Semiconductor and its officers, employees, subsidiaries, affiliates, and distributors harmless against all claims, costs, damages, and expenses, and reasonable attorney fees arising out of, directly or indirectly, any claim of personal injury or death associated with such unintended or unauthorized use, even if such claim alleges that ON Semiconductor was negligent regarding the design or manufacture of the part. ON Semiconductor is an Equal Opportunity/Affirmative Action Employer. This literature is subject to all applicable copyright laws and is not for resale in any manner.

## PUBLICATION ORDERING INFORMATION

### LITERATURE FULFILLMENT:

Email Requests to: [orderlit@onsemi.com](mailto:orderlit@onsemi.com)

ON Semiconductor Website: [www.onsemi.com](http://www.onsemi.com)

### TECHNICAL SUPPORT

North American Technical Support:  
Voice Mail: 1 800-282-9855 Toll Free USA/Canada  
Phone: 011 421 33 790 2910

Europe, Middle East and Africa Technical Support:

Phone: 00421 33 790 2910

For additional information, please contact your local Sales Representative