

# IntelliMAX™ Advanced Load Products

## FPF1007 - FPF1009

### General Description

The FPF1007/8/9 are low  $R_{DS}$  P-Channel MOSFET load switches offered in a selection of 10  $\mu$ s, 80  $\mu$ s, and 1 ms slew rate turn-on options for transient / in-rush current control. To support trends in mobile application requirements, the minimum operating input voltage has been reduced down to 1.2 V, the input current leakage has been minimized to extend battery life, and the ESD-protection has been designed to withstand a minimum of 8 kV (HBM) and 2 kV (CDM).

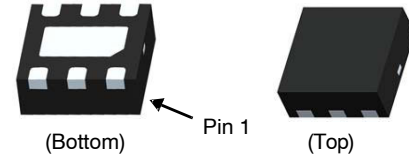
The switch is controlled by an active-high logic input (ON pin), allowing direct interface with a low-voltage control signal. An internal ON pin pull-down resistor protects against unintentional device turn-on in the initial state. An on-chip pull-down resistor on the output is enabled when the switch is turned-off and provides quick, robust discharge of the output load.

### Features

- 1.2 to 5.5 V Input Voltage Range
- Typical  $R_{ON} = 30\text{ m}\Omega$  at  $V_{IN} = 5.5\text{ V}$
- Typical  $R_{ON} = 40\text{ m}\Omega$  at  $V_{IN} = 3.3\text{ V}$
- Fixed Three Different Turn-on Rise Time 10  $\mu$ s / 80  $\mu$ s / 1 ms
- Low  $< 10\text{ }\mu\text{A}$  at  $V_{IN} = 3.3\text{ V}$  Quiescent Current
- Internal ON Pin Pull Down
- Output Discharge Function
- ESD Protection above 8000 V HBM and 2000 V CDM
- These Devices are Pb-Free, Halogen Free/BFR Free and are RoHS Compliant

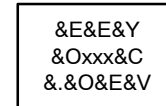
### Applications

- PDAs
- Cell Phones
- GPS Devices
- MP3 Players
- Digital Cameras
- Peripheral Ports
- Hot-Swap Supplies
- Notebook Computers



WDFN6 2x2, 0.65P  
CASE 511CY

### MARKING DIAGRAM



- &E = Designates Space
- &Y = Binary Calendar Year Coding Scheme
- &O = Plant Code identifier
- xxx = Device Specific Code
- &C = Single digit Die Run Code
- &. = Pin One Dot
- &V = Eight-Week Binary Datecoding Scheme

### ORDERING INFORMATION

See detailed ordering and shipping information on page 10 of this data sheet.

# FPF1007 – FPF1009

## Typical Application Circuit

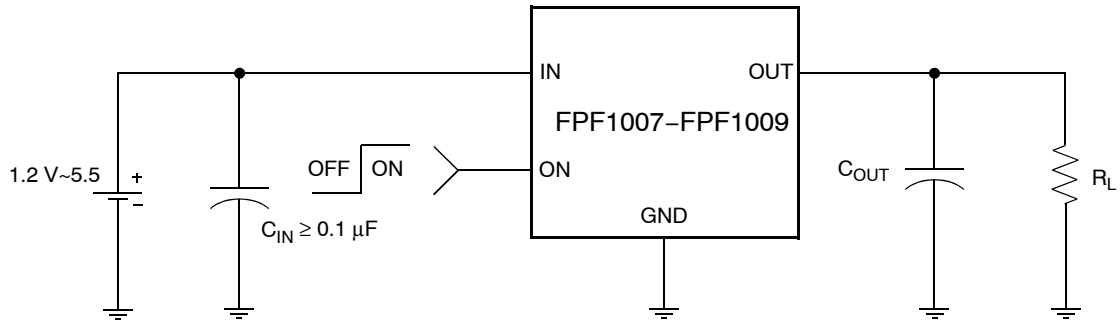


Figure 1. Typical Application Circuit

## Functional Block Diagram

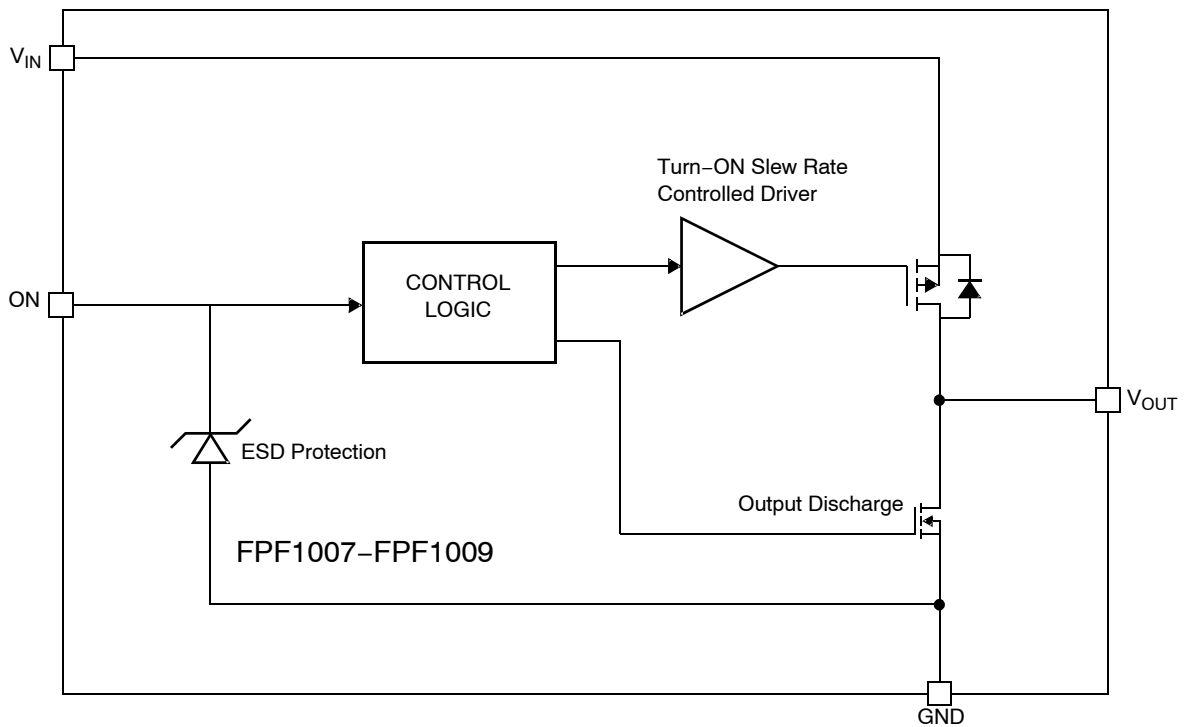
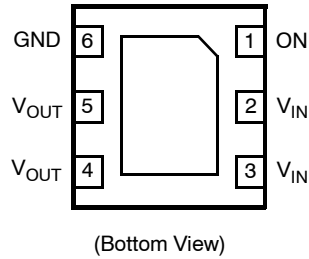


Figure 2. Functional Block Diagram

# FPF1007 – FPF1009

## Pin Configuration



**Figure 3. Pin Configuration**

### PIN DESCRIPTIONS

Name	Type	Description
4, 5	V <sub>OUT</sub>	Switch Output: Output of the power switch
2, 3	V <sub>IN</sub>	Supply Input: Input to the power switch and the supply voltage for the IC
6	GND	Ground
1	ON	ON/OFF Control Input

### ABSOLUTE MAXIMUM RATINGS

Parameter	Min	Max	Unit
V <sub>IN</sub> , V <sub>OUT</sub> , ON to GND	-0.3	6.0	V
Maximum Continuous Switch Current		1.5	A
Power Dissipation at T <sub>A</sub> = 25°C (Note 1)		1.2	W
Storage Junction Temperature	-65	150	°C
Operating Temperature Range	-40	85	°C
Thermal Resistance, Junction to Ambient		86	°C/W
Electrostatic Discharge Protection	HBM	8000	V
	CDM	2000	

Stresses exceeding those listed in the Maximum Ratings table may damage the device. If any of these limits are exceeded, device functionality should not be assumed, damage may occur and reliability may be affected.

1. Package power dissipation on 1 square inch pad, 2 oz. copper board.

### RECOMMENDED OPERATING RANGE

Symbol	Parameter	Min	Max	Unit
V <sub>IN</sub>	Input Voltage	1.2	5.5	V
T <sub>A</sub>	Ambient Operating Temperature	-40	85	°C

Functional operation above the stresses listed in the Recommended Operating Ranges is not implied. Extended exposure to stresses beyond the Recommended Operating Ranges limits may affect device reliability.

# FPF1007 – FPF1009

## ELECTRICAL CHARACTERISTICS

$V_{IN} = 1.2$  to  $5.5$  V,  $T_A = -40$  to  $+85^\circ\text{C}$  unless otherwise noted. Typical values are at  $V_{IN} = 3.3$  V and  $T_A = 25^\circ\text{C}$ .

Symbol	Parameter	Test Condition	Min	Typ	Max	Unit
<b>Basic Operation</b>						
$V_{IN}$	Operating Voltage		1.2		5.5	V
$I_Q$	Quiescent Current	$I_{OUT} = 0$ mA $V_{ON} = \text{Enabled}$	$V_{IN} = 3.3$ V	8		$\mu\text{A}$
			$V_{IN} = 5.5$ V		15	
$I_{Q(\text{off})}$	Off Supply Current	$V_{ON} = \text{GND}$ , $V_{OUT} = \text{OPEN}$			1	$\mu\text{A}$
$I_{SD(\text{off})}$	Off Switch Current	$V_{ON} = \text{GND}$ , $V_{OUT} = \text{GND}$		0.1	1.0	$\mu\text{A}$
$R_{ON}$	On-Resistance	$V_{IN} = 5.5$ V, $I_{OUT} = 200$ mA, $T_A = 25^\circ\text{C}$		30	40	$\text{m}\Omega$
		$V_{IN} = 3.3$ V, $I_{OUT} = 200$ mA, $T_A = 25^\circ\text{C}$		40	55	
		$V_{IN} = 1.5$ V, $I_{OUT} = 200$ mA, $T_A = 25^\circ\text{C}$		100	130	
		$V_{IN} = 1.2$ V, $I_{OUT} = 200$ mA, $T_A = 25^\circ\text{C}$		175	250	
		$V_{IN} = 3.3$ V, $I_{OUT} = 200$ mA, $T_A = -40^\circ\text{C}$ to $+85^\circ\text{C}$	20		65	
$R_{PD}$	Output Pull Down Resistance	$V_{IN} = 3.3$ V, $V_{ON} = 0$ V, $T_A = 25^\circ\text{C}$		60		$\Omega$
$V_{IL}$	ON Input Logic Low Voltage	$V_{IN} = 1.2$ V to $5.5$ V			0.4	V
$V_{IH}$	ON Input Logic High Voltage	$V_{IN} = 1.2$ V to $5.5$ V	1			V
	ON Input Leakage (On)	$V_{ON} = V_{IN} = 5.5$ V			10	$\mu\text{A}$
	ON Input Leakage (Off)	$V_{ON} = \text{GND}$			1	$\mu\text{A}$

## Dynamic

### FPF1007

$t_{ON}$	Turn On Time	$V_{IN} = 3.3$ V, $R_L = 500$ $\Omega$ , $R_{L\_CHIP} = 60$ $\Omega$ , $C_{OUT} = 0.1$ $\mu\text{F}$ , $T_A = 25^\circ\text{C}$		12		$\mu\text{s}$
$t_R$	Rise Time			10		$\mu\text{s}$
$t_{OFF}$	Turn Off Time			40		$\mu\text{s}$
$t_F$	Fall Time			15		$\mu\text{s}$

### FPF1008

$t_{ON}$	Turn On Time	$V_{IN} = 3.3$ V, $R_L = 500$ $\Omega$ , $R_{L\_CHIP} = 60$ $\Omega$ , $C_{OUT} = 0.1$ $\mu\text{F}$ , $T_A = 25^\circ\text{C}$		125		$\mu\text{s}$
$t_R$	Rise Time			80		$\mu\text{s}$
$t_{OFF}$	Turn Off Time			40		$\mu\text{s}$
$t_F$	Fall Time			15		$\mu\text{s}$

### FPF1009

$t_{ON}$	Turn On Time	$V_{IN} = 3.3$ V, $R_L = 500$ $\Omega$ , $R_{L\_CHIP} = 60$ $\Omega$ , $C_{OUT} = 0.1$ $\mu\text{F}$ , $T_A = 25^\circ\text{C}$		2		ms
$t_R$	Rise Time			1		ms
$t_{OFF}$	Turn Off Time			40		$\mu\text{s}$
$t_F$	Fall Time			15		$\mu\text{s}$

Product parametric performance is indicated in the Electrical Characteristics for the listed test conditions, unless otherwise noted. Product performance may not be indicated by the Electrical Characteristics if operated under different conditions.

TYPICAL CHARACTERISTICS

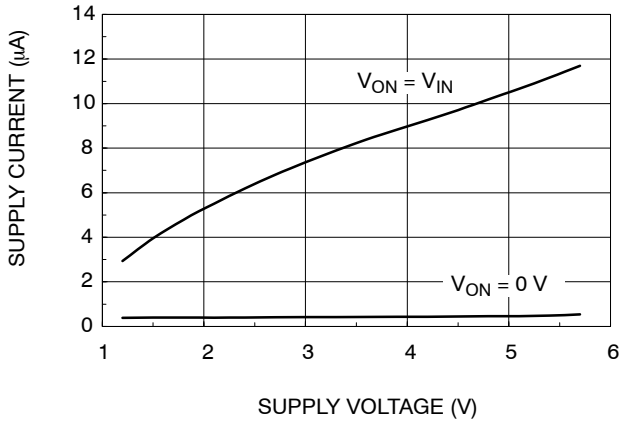


Figure 4. Quiescent Current vs. Input Voltage

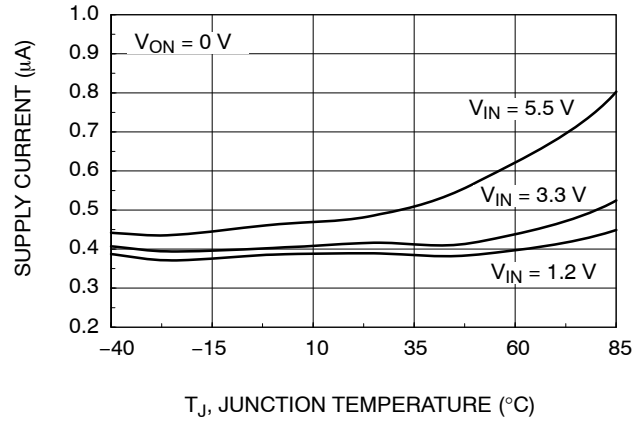


Figure 5. Quiescent Current vs. Temperature

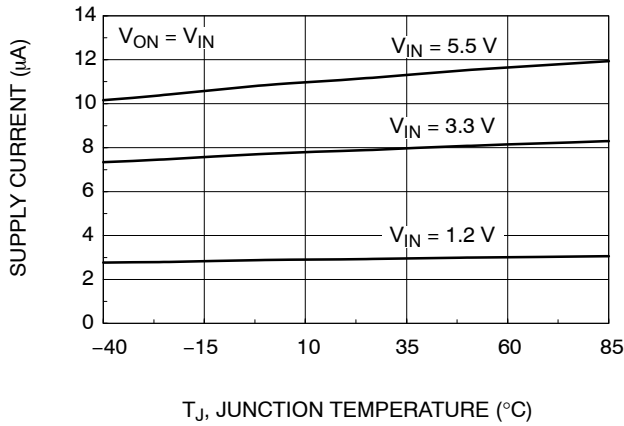


Figure 6. Quiescent Current vs. Temperature

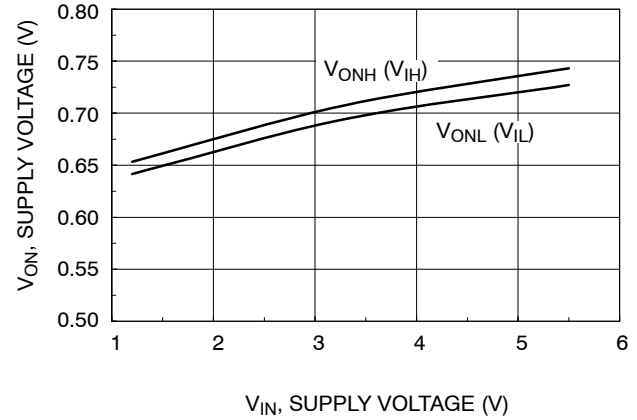


Figure 7.  $V_{ON}$  Voltage vs. Input Voltage

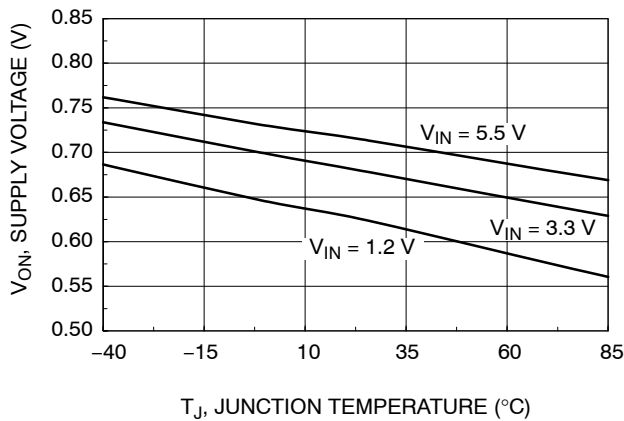


Figure 8.  $V_{ON}$  Low Voltage vs. Temperature

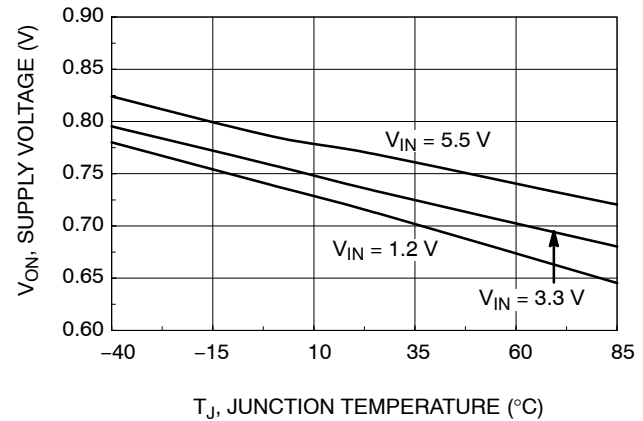


Figure 9.  $V_{ON}$  High Voltage vs. Temperature

# FPF1007 – FPF1009

## TYPICAL CHARACTERISTICS (continued)

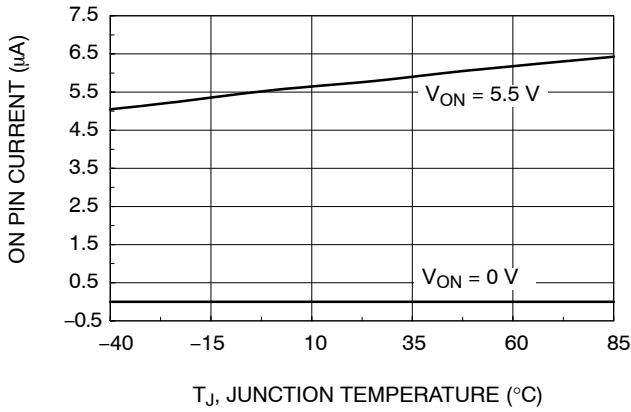


Figure 10. On Pin Current vs. Temperature

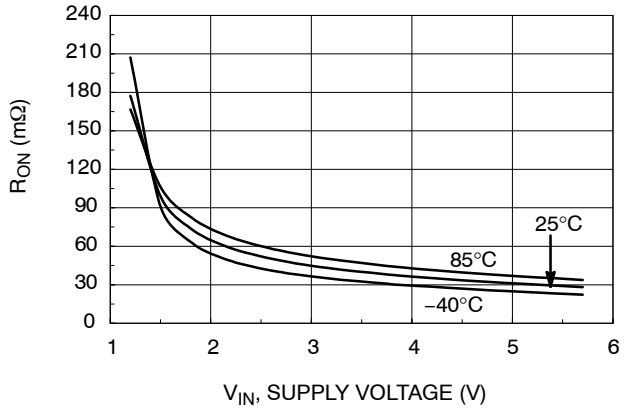


Figure 11.  $R_{ON}$  vs.  $V_{IN}$

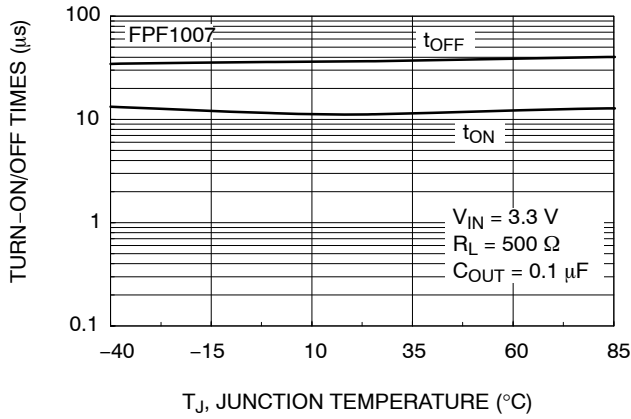


Figure 12. FPF1007  $t_{ON}$  /  $t_{OFF}$  vs. Temperature

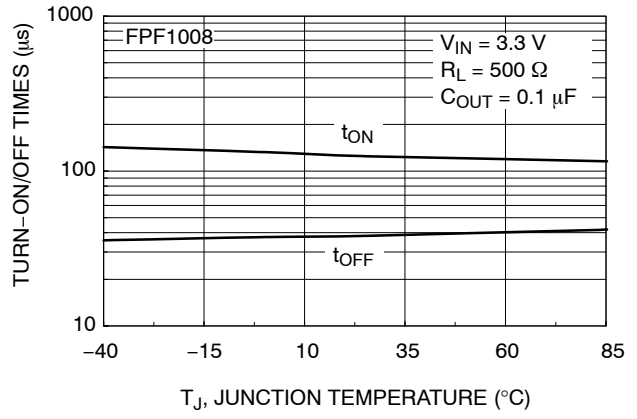


Figure 13. FPF1008  $t_{ON}$  /  $t_{OFF}$  vs. Temperature

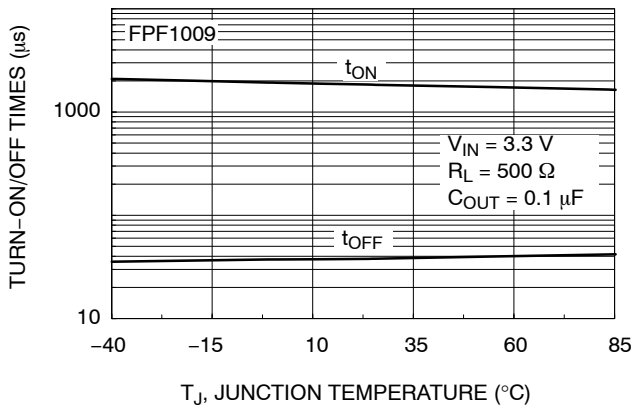


Figure 14. FPF1009  $t_{ON}$  /  $t_{OFF}$  vs. Temperature

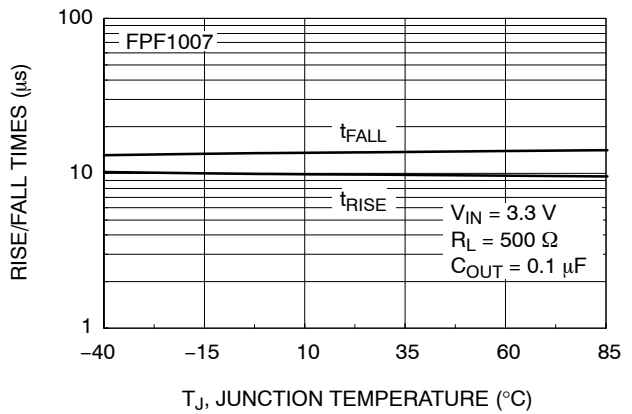


Figure 15. FPF1007  $t_{RISE}$  /  $t_{FALL}$  vs. Temperature

# FPF1007 – FPF1009

## TYPICAL CHARACTERISTICS (continued)

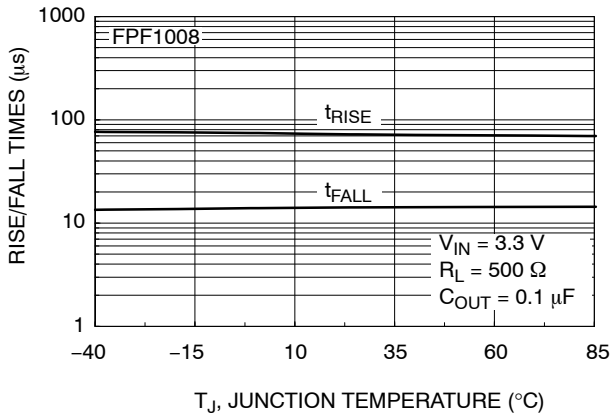


Figure 16. FPF1008  $t_{\text{RISE}} / t_{\text{FALL}}$  vs. Temperature

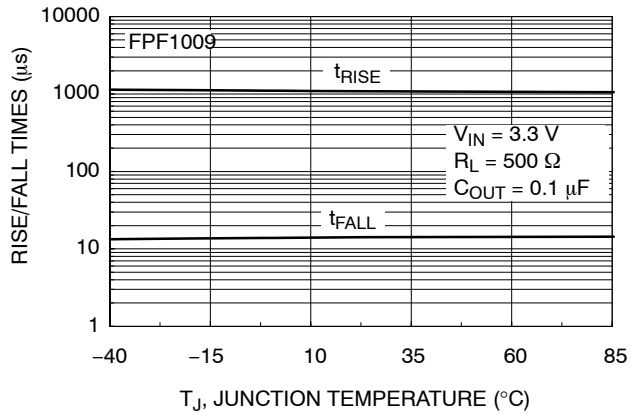


Figure 17. FPF1009  $t_{\text{RISE}} / t_{\text{FALL}}$  vs. Temperature

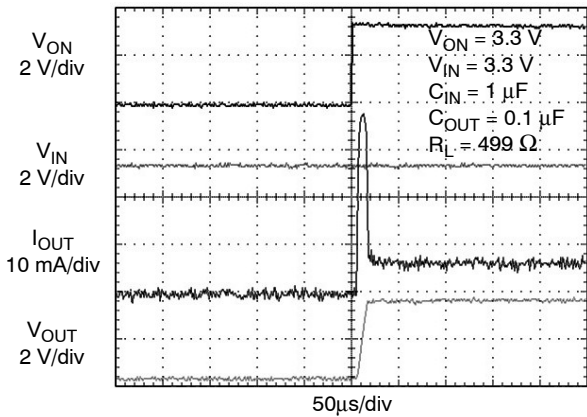


Figure 18. FPF1007 Turn-On Response

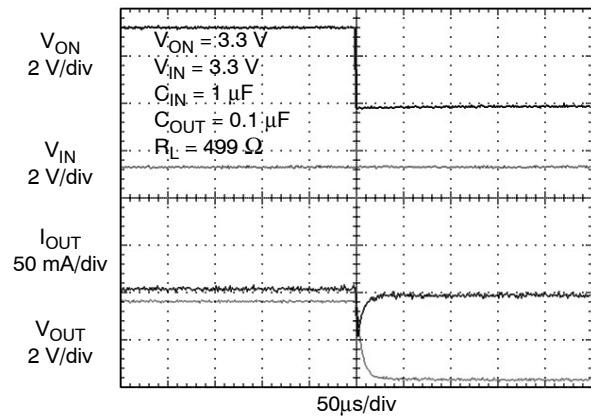


Figure 19. FPF1007 Turn-Off Response

Load current discharged through on-chip output discharge resistor

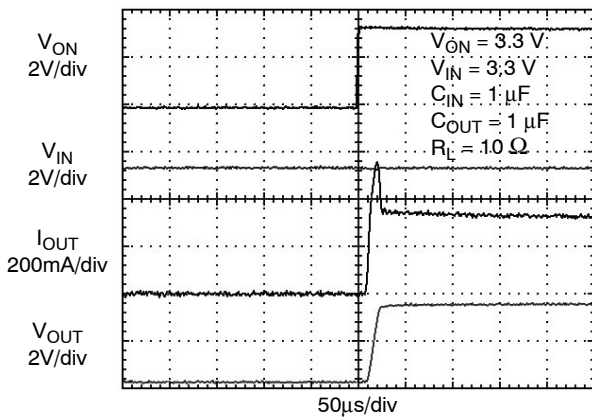


Figure 20. FPF1007 Turn-On Response ( $C_{\text{OUT}} = 1 \mu\text{F}$ )

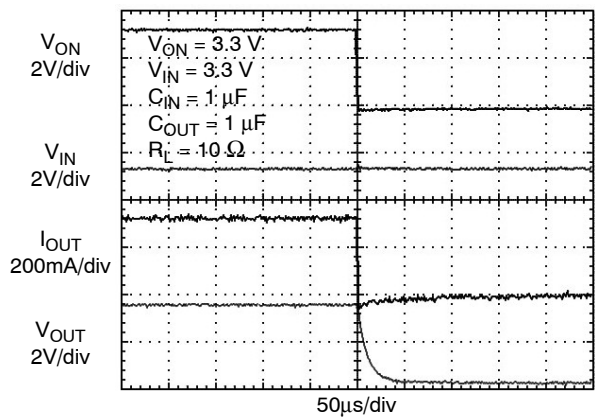


Figure 21. FPF1007 Turn-Off Response

# FPF1007 – FPF1009

## TYPICAL CHARACTERISTICS (continued)

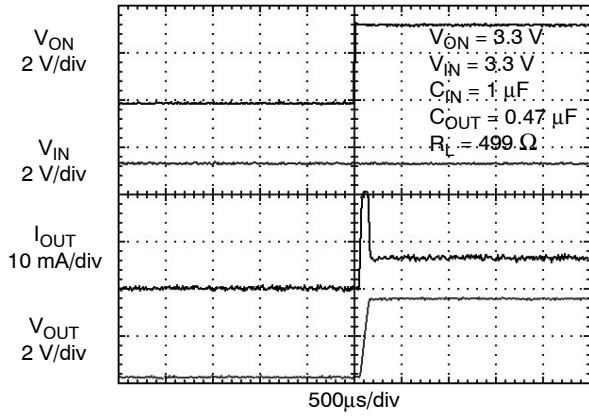


Figure 22. FPF1008 Turn-On Response

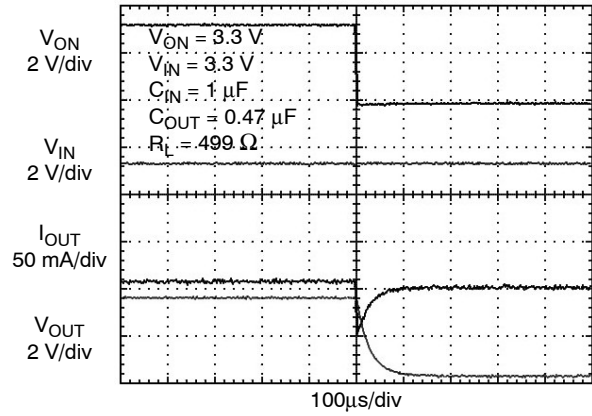


Figure 23. FPF1008 Turn-Off Response

Load current discharged through on-chip output discharge resistor

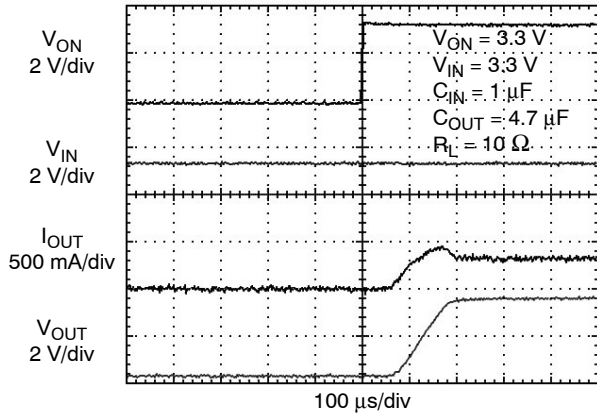


Figure 24. FPF1008 Turn-On Response  
( $C_{OUT} = 4.7 \mu\text{F}$ )

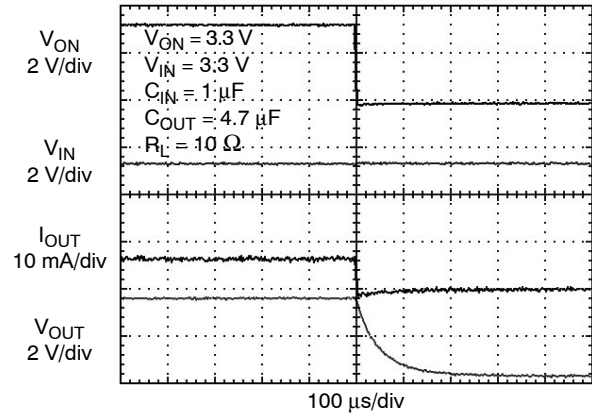


Figure 25. FPF1008 Turn-Off Response

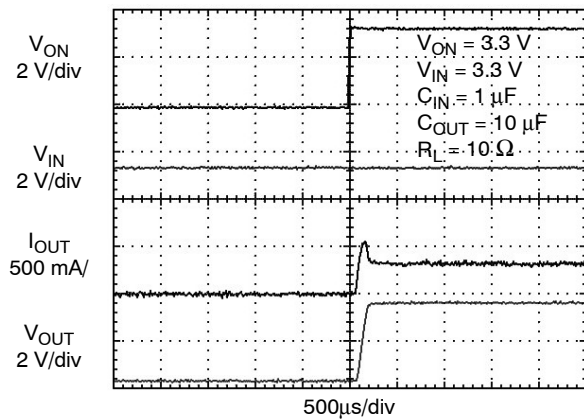


Figure 26. FPF1008 Turn-On Response  
( $C_{OUT} = 10 \mu\text{F}$ )

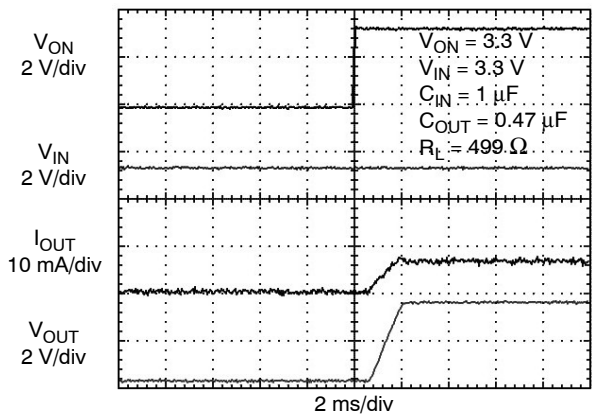
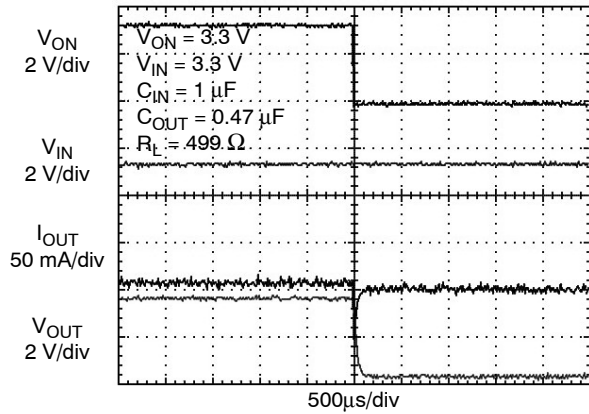


Figure 27. FPF1009 Turn-On Response



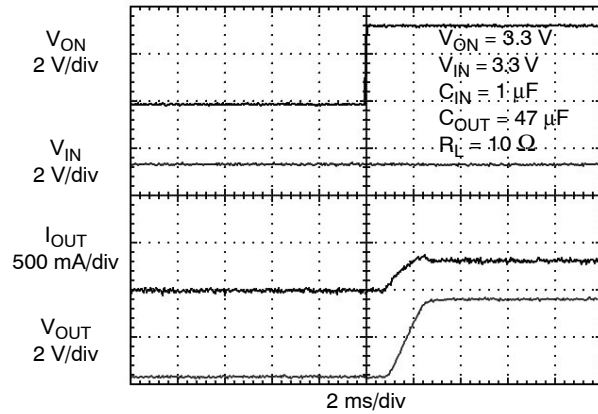
# FPF1007 – FPF1009

## TYPICAL CHARACTERISTICS (continued)

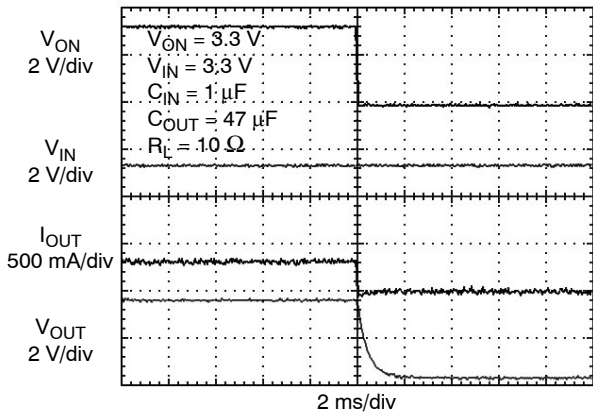


**Figure 28. FPF1009 Turn-Off Response**

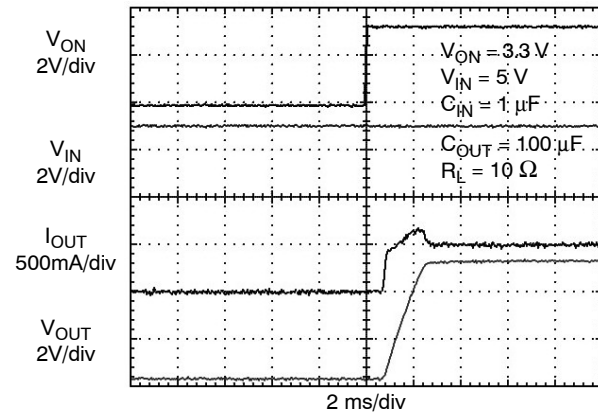
Load current discharged through on-chip output discharge resistor



**Figure 29. FPF1009 Turn-On Response**  
( $C_{OUT} = 47 \mu\text{F}$ )

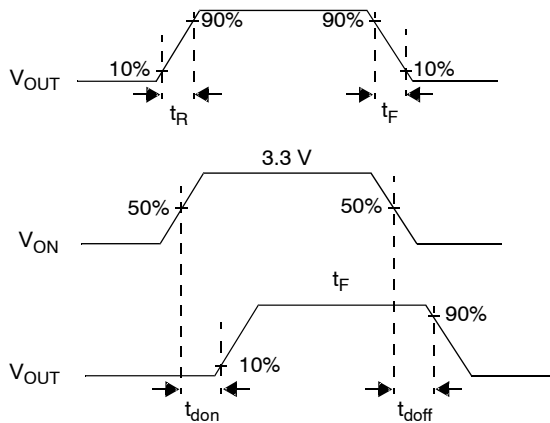


**Figure 30. FPF1009 Turn-Off Response**



**Figure 31. FPF1009 Turn-On Response**  
( $C_{OUT} = 100 \mu\text{F}$ ,  $V_{IN} = 5 \text{ V}$ )

### Timing Diagram



where:

- $t_{ON}$  = Turn-On Time
- $t_{OFF}$  = Turn-Off Time
- $t_{don}$  = Turn-On Delay Time
- $t_{doff}$  = Turn-Off Delay Time
- $t_R$  = Rise Time
- $t_F$  =  $V_{OUT}$  Fall Time
- $t_{ON} = t_R + t_{don}$
- $t_{OFF} = t_F + t_{doff}$

**Figure 32. Timing Diagram**

## FPF1007 – FPF1009

### ORDERING INFORMATION

Part Number	Switch R <sub>ON</sub> at 5.5 V (Typ.)	Rise Time (Typ.)	Output Discharge (Typ.)	ON Pin Activity	Top Mark	Shipping <sup>†</sup>
FPF1007	30 mΩ, PMOS	10 μs	60 Ω	Active HIGH	007	3000 / Tape & Reel
FPF1008	30 mΩ, PMOS	80 μs	60 Ω	Active HIGH	008	3000 / Tape & Reel
FPF1009	30 mΩ, PMOS	1 ms	60 Ω	Active HIGH	009	3000 / Tape & Reel

<sup>†</sup>For information on tape and reel specifications, including part orientation and tape sizes, please refer to our Tape and Reel Packaging Specifications Brochure, BRD8011/D

IntelliMAX is a trademark of Semiconductor Components Industries, LLC dba "onsemi" or its affiliates and/or subsidiaries in the United States and/or other countries.

# MECHANICAL CASE OUTLINE

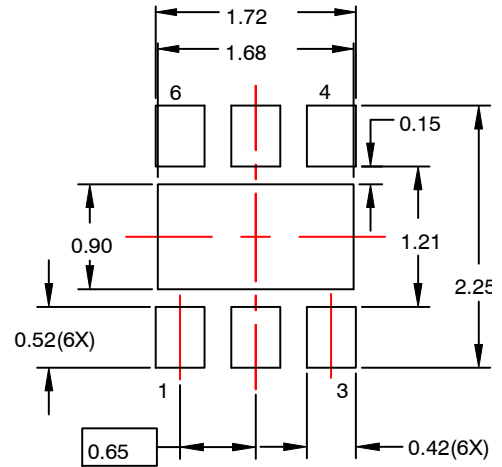
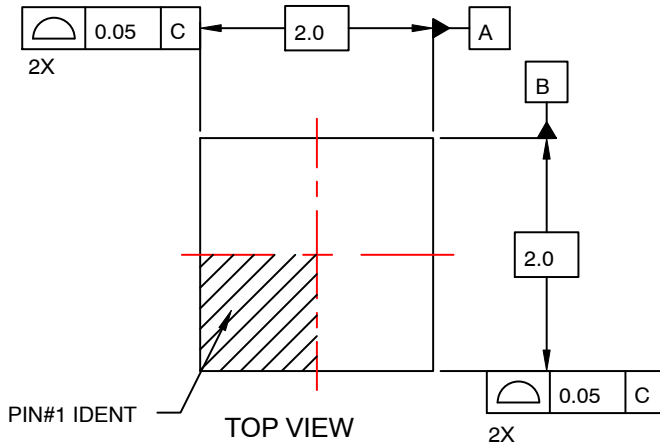
## PACKAGE DIMENSIONS

ON Semiconductor®

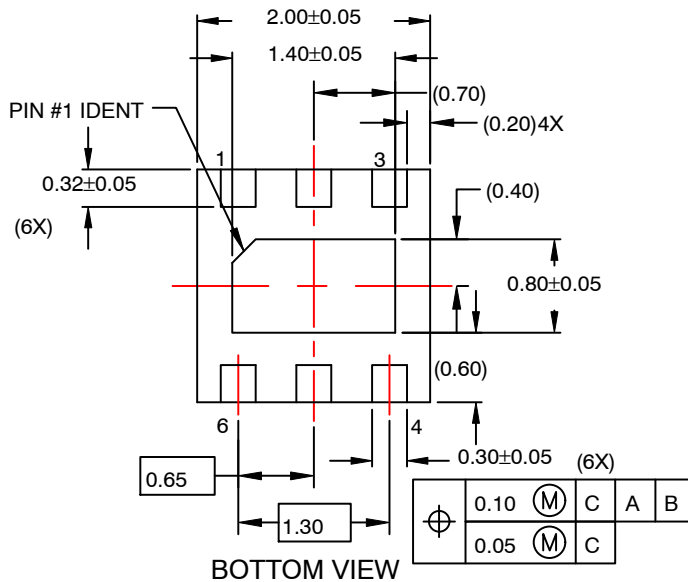
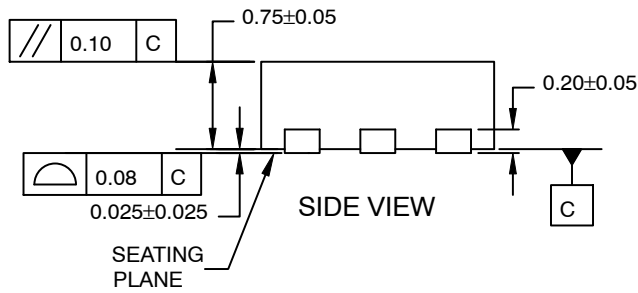


WDFN6 2x2, 0.65P  
CASE 511CY  
ISSUE O

DATE 31 JUL 2016



### RECOMMENDED LAND PATTERN



### NOTES:

- A. PACKAGE DOES NOT FULLY CONFORM TO JEDEC MO-229 REGISTRATION
- B. DIMENSIONS ARE IN MILLIMETERS.
- C. DIMENSIONS AND TOLERANCES PER ASME Y14.5M, 2009.
- D. LAND PATTERN RECOMMENDATION IS EXISTING INDUSTRY LAND PATTERN.

<b>DOCUMENT NUMBER:</b>	<b>98AON13613G</b>	Electronic versions are uncontrolled except when accessed directly from the Document Repository. Printed versions are uncontrolled except when stamped "CONTROLLED COPY" in red.
<b>DESCRIPTION:</b>	<b>WDFN6 2X2, 0.65P</b>	<b>PAGE 1 OF 1</b>

ON Semiconductor and are trademarks of Semiconductor Components Industries, LLC dba ON Semiconductor or its subsidiaries in the United States and/or other countries. ON Semiconductor reserves the right to make changes without further notice to any products herein. ON Semiconductor makes no warranty, representation or guarantee regarding the suitability of its products for any particular purpose, nor does ON Semiconductor assume any liability arising out of the application or use of any product or circuit, and specifically disclaims any and all liability, including without limitation special, consequential or incidental damages. ON Semiconductor does not convey any license under its patent rights nor the rights of others.

**onsemi**, **Onsemi**, and other names, marks, and brands are registered and/or common law trademarks of Semiconductor Components Industries, LLC dba "**onsemi**" or its affiliates and/or subsidiaries in the United States and/or other countries. **onsemi** owns the rights to a number of patents, trademarks, copyrights, trade secrets, and other intellectual property. A listing of **onsemi**'s product/patent coverage may be accessed at [www.onsemi.com/site/pdf/Patent-Marking.pdf](http://www.onsemi.com/site/pdf/Patent-Marking.pdf). **onsemi** reserves the right to make changes at any time to any products or information herein, without notice. The information herein is provided "as-is" and **onsemi** makes no warranty, representation or guarantee regarding the accuracy of the information, product features, availability, functionality, or suitability of its products for any particular purpose, nor does **onsemi** assume any liability arising out of the application or use of any product or circuit, and specifically disclaims any and all liability, including without limitation special, consequential or incidental damages. Buyer is responsible for its products and applications using **onsemi** products, including compliance with all laws, regulations and safety requirements or standards, regardless of any support or applications information provided by **onsemi**. "Typical" parameters which may be provided in **onsemi** data sheets and/or specifications can and do vary in different applications and actual performance may vary over time. All operating parameters, including "Typicals" must be validated for each customer application by customer's technical experts. **onsemi** does not convey any license under any of its intellectual property rights nor the rights of others. **onsemi** products are not designed, intended, or authorized for use as a critical component in life support systems or any FDA Class 3 medical devices or medical devices with a same or similar classification in a foreign jurisdiction or any devices intended for implantation in the human body. Should Buyer purchase or use **onsemi** products for any such unintended or unauthorized application, Buyer shall indemnify and hold **onsemi** and its officers, employees, subsidiaries, affiliates, and distributors harmless against all claims, costs, damages, and expenses, and reasonable attorney fees arising out of, directly or indirectly, any claim of personal injury or death associated with such unintended or unauthorized use, even if such claim alleges that **onsemi** was negligent regarding the design or manufacture of the part. **onsemi** is an Equal Opportunity/Affirmative Action Employer. This literature is subject to all applicable copyright laws and is not for resale in any manner.

## PUBLICATION ORDERING INFORMATION

### LITERATURE FULFILLMENT:

Email Requests to: [orderlit@onsemi.com](mailto:orderlit@onsemi.com)

**onsemi Website:** [www.onsemi.com](http://www.onsemi.com)

### TECHNICAL SUPPORT

**North American Technical Support:**

Voice Mail: 1 800-282-9855 Toll Free USA/Canada

Phone: 011 421 33 790 2910

**Europe, Middle East and Africa Technical Support:**

Phone: 00421 33 790 2910

For additional information, please contact your local Sales Representative