

800 V and 600 V, 25 A standard Triacs in TOP3 package

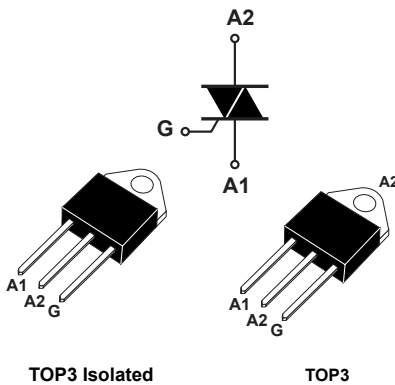

Features

- High current Triac
- Low thermal resistance with clip bonding
- Standard commutation (4 quadrants) or snubberless (3 quadrants), both with high turn-off commutation
- BTA26 UL1557 recognized components (file ref: 81734)
- RoHS (2002/95/EC) compliant packages

Applications

- On/off function in static relays, heating regulation, induction motor starting circuits
- Phase control operations in light dimmers and motor speed controllers

Description

Available in TOP3 insulated and non-insulated package, BTA26 and BTB26 are suitable for general purpose AC switching.

BTA26 and BTB26 provide an insulated tab (rated at 2500 V_{RMS}). These components are UL recognized and meet UL 1557 (file ref. 81734).



Product status link	
BTA26	TOP3 isolated package
BTB26	TOP3 package

Product summary	
$I_{T(RMS)}$	25 A
V_{DRM}/V_{RRM}	600 V to 800 V
$I_{GT(standard)}$	50 mA
$I_{GT(Snubberless)}$ BTA26 ⁽¹⁾	35 / 50 mA

1. 600 V version available only with $I_{GT} = 50$ mA (Snubberless and Standard)

1 Characteristics

Table 1. Absolute maximum ratings

Symbol	Parameters	Value	Unit	
$I_{T(RMS)}$	RMS on-state current (180° conduction angle)	BTA26 (TOP3 Ins.) $T_c = 100\text{ °C}$	25	A
		BTB26 (TOP3) $T_c = 105\text{ °C}$		
I_{TSM}	Non repetitive surge peak on-state current (full cycle, T_j initial = 25 °C)	f = 60 Hz $t_p = 16,7\text{ ms}$	260	A
		f = 50 Hz $t_p = 20\text{ ms}$	250	
I^2t	I^2t value for fusing	$t_p = 10\text{ ms}$	340	A ² s
di/dt	Critical rate of rise of on-state current $I_G = 2 \times I_{GT}$, $t_r \leq 100\text{ ns}$	f = 120 Hz $T_j = 125\text{ °C}$	50	A/ μ s
V_{DSM}, V_{RSM}	Non repetitive surge peak off-state voltage	$t_p = 20\text{ ms}$ $T_j = 25\text{ °C}$	$V_{DRM}, V_{RRM} + 100$	V
I_{GM}	Peak gate current	$t_p = 20\text{ }\mu$ s $T_j = 125\text{ °C}$	4	A
$P_{G(AV)}$	Average gate power dissipation	$T_j = 125\text{ °C}$	1	W
T_{stg}	Storage junction temperature range		-40 to +150	°C
T_j	Operating junction temperature range		-40 to +125	°C
T_L	Maximum lead temperature for soldering during 10 s		250	°C
V_{INS}	Insulation RMS voltage, 1 minute		2500	V

Table 2. Electrical characteristics ($T_j = 25\text{ °C}$, unless otherwise specified) - Snubberless and Standard (3 quadrants)

Symbol	Parameters	Quadrant		BTA/BTB		Unit
				CW	BW	
$I_{GT}^{(1)}$	$V_D = 12\text{ V}, R_L = 33\text{ }\Omega$	I - II - III	Max.	35	50	mA
V_{GT}		I - II - III	Max.	1.3		V
V_{GD}	$V_D = V_{DRM}, R_L = 3.3\text{ k}\Omega, T_j = 125\text{ °C}$	I - II - III	Min.	0.2		V
$I_H^{(2)}$	$I_T = 500\text{ mA}$		Max.	50	75	mA
I_L	$I_G = 1.2 I_{GT}$	I - III	Max.	70	80	mA
		II	Max.	80	100	
$dV/dt^{(2)}$	$V_D = 67\% V_{DRM}$ gate open, $T_j = 125\text{ °C}$		Min.	500	1000	V/ μ s
$(di/dt)_c^{(2)}$	$(di/dt)_c = 20\text{ A/ms}$, without snubber at $T_j = 125\text{ °C}$		Min.	13	22	A/ms

1. Minimum I_{GT} is guaranteed at 5 % of I_{GT} max.
2. For both polarities of A2 referenced to A1

Table 3. Electrical characteristics ($T_j = 25\text{ }^\circ\text{C}$, unless otherwise specified) - Standard (4 quadrants)

Symbol	Parameters	Quadrant		Value	Unit
$I_{GT}^{(1)}$	$V_D = 12\text{ V}$, $R_L = 33\ \Omega$	I - II - III IV	Max.	50	mA
V_{GT}				100	
V_{GD}	$V_D = V_{DRM}$, $R_L = 3.3\text{ k}\Omega$, $T_j = 125\text{ }^\circ\text{C}$	All	Max.	1.3	V
$I_H^{(2)}$	$I_T = 500\text{ mA}$	All	Min.	0.2	V
I_L	$I_G = 1.2\ I_{GT}$	I - III - IV	Max.	70	mA
		II	Max.	160	
$dV/dt^{(2)}$	$V_D = 67\% V_{DRM}$ gate open, $T_j = 125\text{ }^\circ\text{C}$		Min.	500	V/ μs
$(dI/dt)_c^{(2)}$	$(dI/dt)_c = 13.3\text{ A/ms}$, $T_j = 125\text{ }^\circ\text{C}$		Min.	10	V/ μs

1. Minimum I_{GT} is guaranteed at 5 % of I_{GT} max.

2. For both polarities of A2 referenced to A1

Table 4. Static electrical characteristics

Symbol	Test conditions	T_j		Value	Unit
$V_{TM}^{(1)}$	$I_{TM} = 35\text{ A}$, $t_p = 380\ \mu\text{s}$	$25\text{ }^\circ\text{C}$	Max.	1.55	V
$V_{TO}^{(1)}$	threshold on-state voltage	$125\text{ }^\circ\text{C}$	Max.	0.85	V
$R_D^{(1)}$	Dynamic resistance	$125\text{ }^\circ\text{C}$	Max.	16	m Ω
I_{DRM}/I_{RRM}	$V_T = V_{DRM}$, $V_T = V_{RRM}$	$25\text{ }^\circ\text{C}$	Max.	5	μA
		$125\text{ }^\circ\text{C}$		3	mA

1. For both polarities of A2 referenced to A1

Table 5. Thermal resistance

Symbol	Parameters			Value	Unit
$R_{th(j-c)}$	Junction to case (AC)	BTA26 (TOP3 Ins.)	Max.	0.9	$^\circ\text{C/W}$
		BTB26 (TOP3)		0.6	
$R_{th(j-a)}$	Junction to ambient	BTA26 (TOP3 Ins.) / BTB26 (TOP3)	Typ.	50	

1.1 Characteristics (curves)

Figure 1. Maximum power dissipation versus on-state RMS current (full cycle)

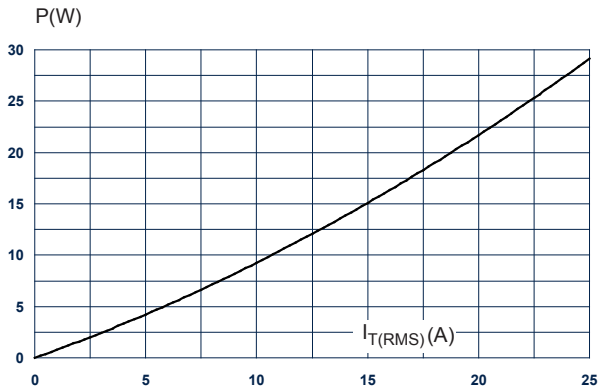

Figure 2. RMS on-state current versus case temperature (full cycle)

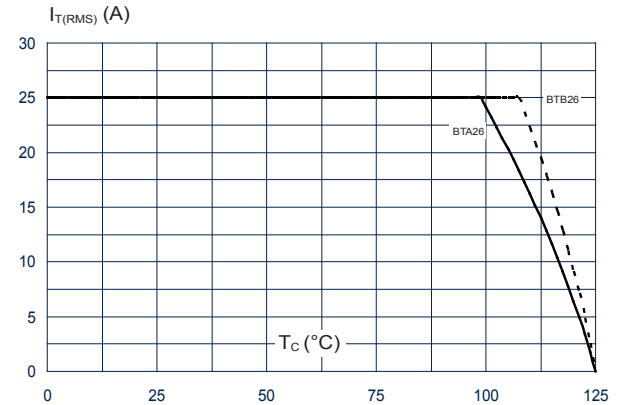

Figure 3. Relative variation of thermal impedance versus pulse duration

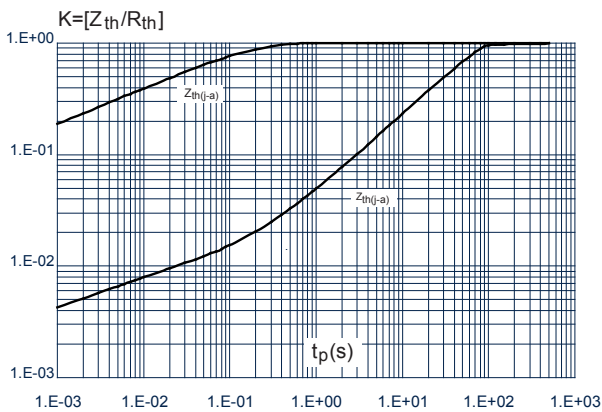

Figure 4. On-state characteristics (maximum values)

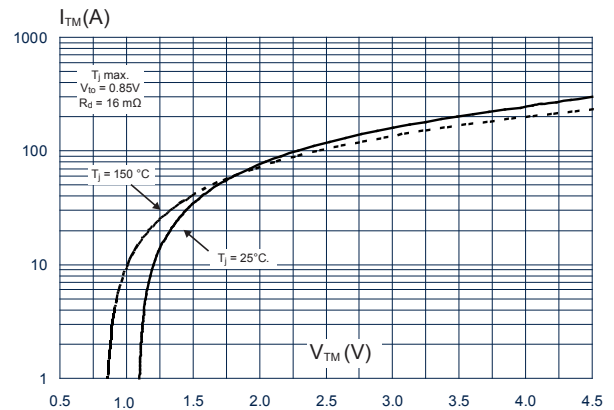

Figure 5. Surge peak on-state current versus number of cycles

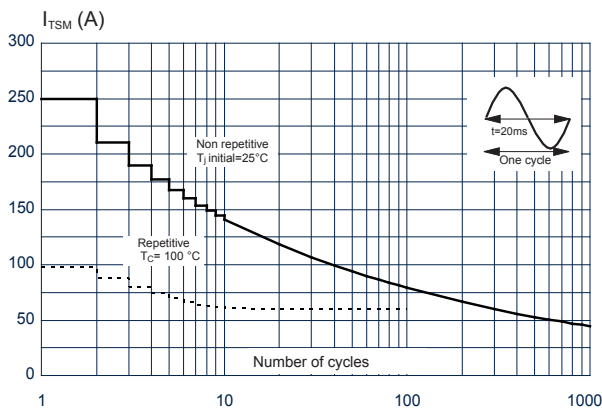

Figure 6. Non-repetitive surge peak on-state current for a sinusoidal pulse with width $t_p < 10$ ms

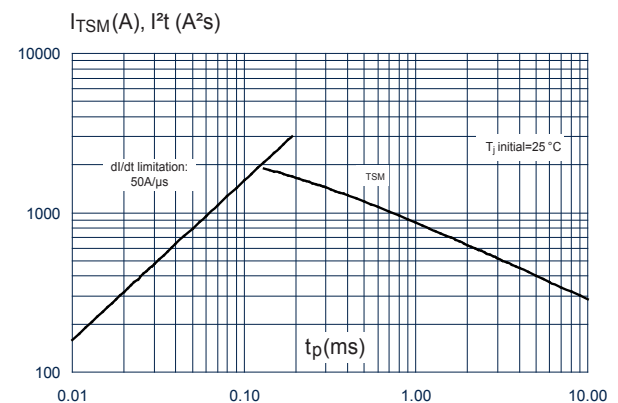

Figure 7. Relative variation of gate trigger current, holding and latching current versus junction temperature (typical values)

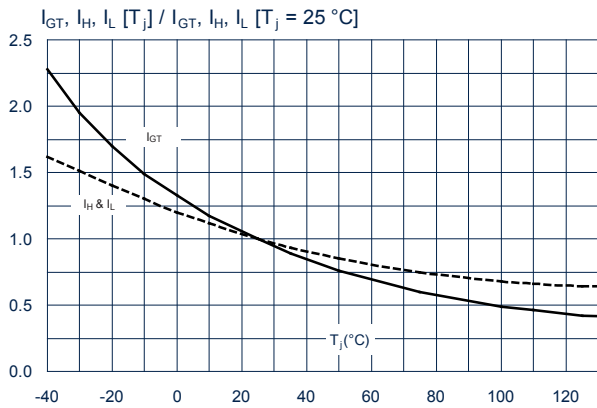

Figure 8. Relative variation of critical rate of decrease of main current versus (dV/dt) (typical values)

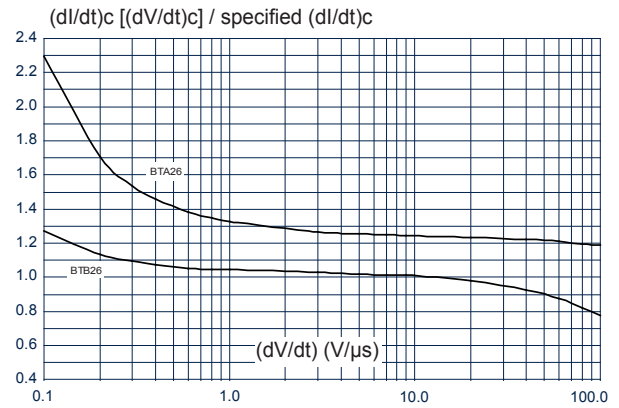

Figure 9. Relative variation of critical rate of decrease of main current versus junction temperature

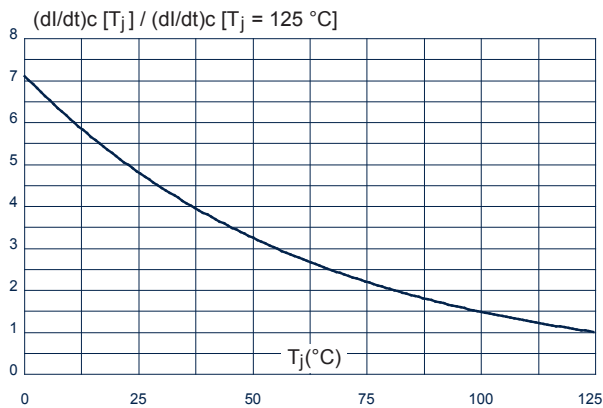
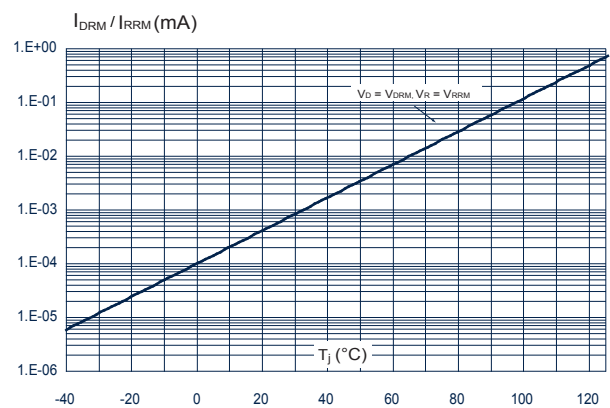

Figure 10. Relative variation of leakage current versus junction temperature for different values of blocking voltage



2 Package information

In order to meet environmental requirements, ST offers these devices in different grades of **ECOPACK** packages, depending on their level of environmental compliance. ECOPACK specifications, grade definitions and product status are available at: www.st.com. ECOPACK is an ST trademark.

2.1 TOP3 insulated and non-insulated package information

- Epoxy meets UL94, V0
- Lead-free packages
- Recommended torque: 1.05 N·m (max. torque: 1.2 N·m)

Figure 11. TOP3 insulated and non-insulated package outline

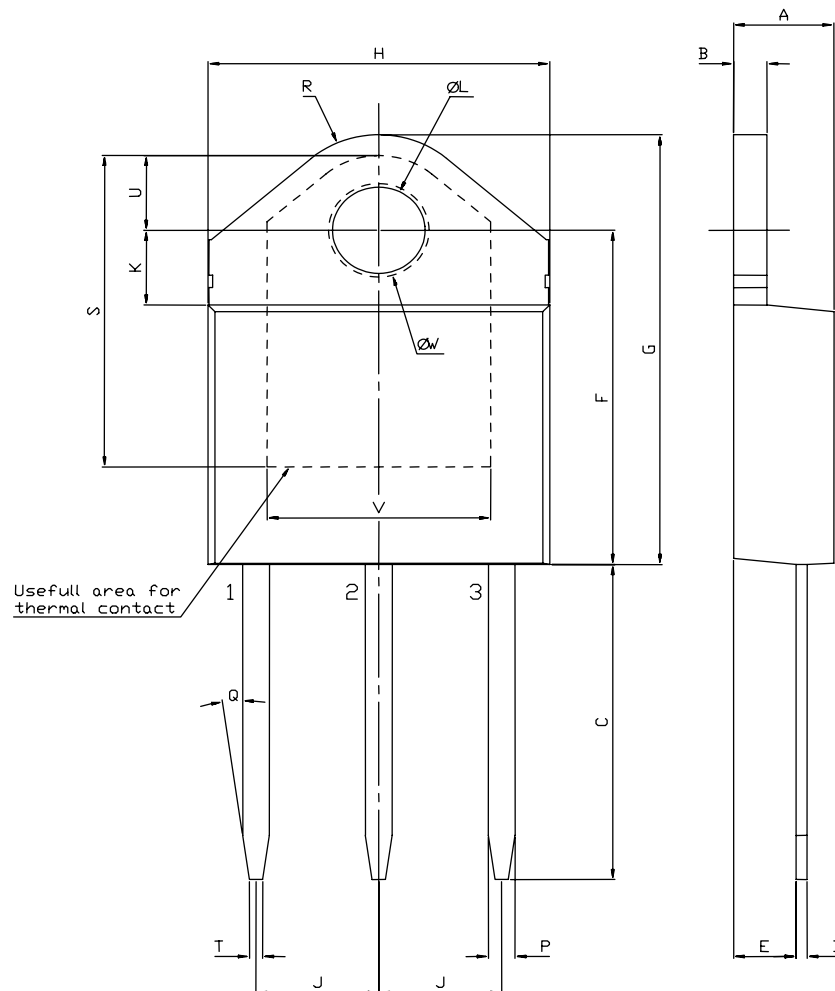

Table 6. TOP3 insulated and non-insulated mechanical data

Ref.	Dimensions					
	mm			Inches ⁽¹⁾		
	Min.	Typ.	Max.	Min.	Typ.	Max.
A	4.40		4.60	0.1732		0.1812
B	1.45		1.55	0.0570		0.0611
C	14.35		15.60	0.5649		0.6142
D	0.50		0.70	0.0196		0.0276
E	2.70		2.90	0.1062		0.1142
F	15.80		16.50	0.6220		0.6497
G	20.40		21.10	0.8031		0.8308
H	15.10		15.50	0.5944		0.6103
J	5.40		5.65	0.2125		0.2225
K	3.40		3.65	0.1338		0.1438
L	4.08		4.17	0.1606		0.1642
M	1.20		1.40	0.0472		0.0552
R		4.60			0.1811	

1. Inches given for reference only

3 Ordering information

Figure 12. Ordering information scheme (BTA26 and BTB26)

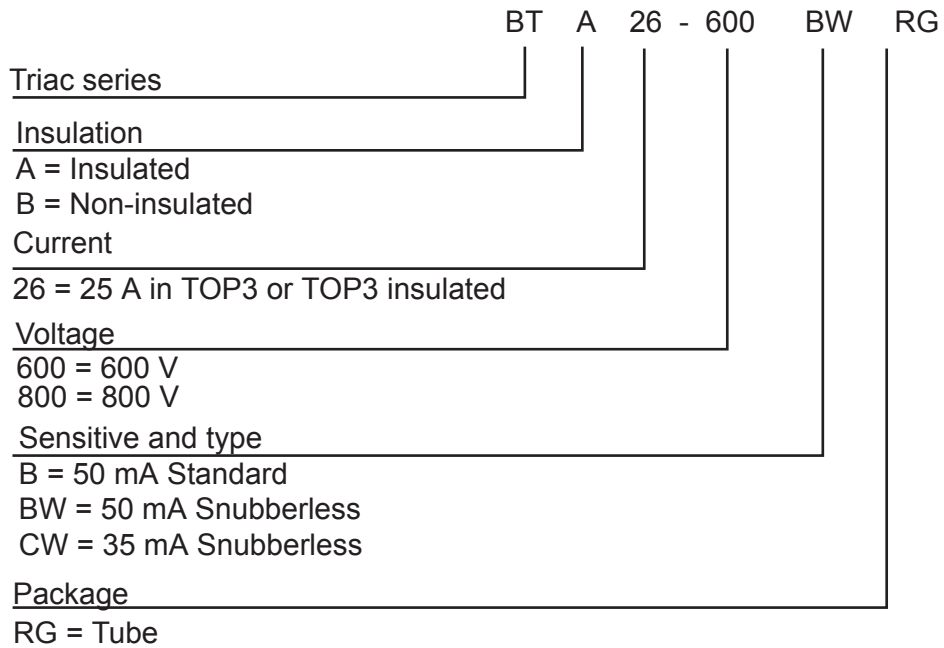

Table 7. Ordering information

Order code	Marking	Package	Weight	Base qty.	Delivery mode
BTA26-600BRG	BTA26600B	TOP3 Ins.	4.5 g	30	Tube
BTA26-600BWRG	BTA26600BW				
BTA26-800BRG	BTA26800B				
BTB26-800BWRG	BTB26800BW	TOP3			
BTB26-800CWRG	BTB26800CW				
BTB26-600BRG	BTB26600B				

Revision history

Table 8. Document revision history

Date	Revision	Changes
03-Aug-2021	1	Initial release.

IMPORTANT NOTICE – PLEASE READ CAREFULLY

STMicroelectronics NV and its subsidiaries (“ST”) reserve the right to make changes, corrections, enhancements, modifications, and improvements to ST products and/or to this document at any time without notice. Purchasers should obtain the latest relevant information on ST products before placing orders. ST products are sold pursuant to ST’s terms and conditions of sale in place at the time of order acknowledgement.

Purchasers are solely responsible for the choice, selection, and use of ST products and ST assumes no liability for application assistance or the design of Purchasers’ products.

No license, express or implied, to any intellectual property right is granted by ST herein.

Resale of ST products with provisions different from the information set forth herein shall void any warranty granted by ST for such product.

ST and the ST logo are trademarks of ST. For additional information about ST trademarks, please refer to www.st.com/trademarks. All other product or service names are the property of their respective owners.

Information in this document supersedes and replaces information previously supplied in any prior versions of this document.

© 2021 STMicroelectronics – All rights reserved