



ON Semiconductor®

<http://onsemi.com>

LA1225MC

Monolithic Linear IC FM IF Detector IC

Overview

The LA1225MC is a Low-voltage operation (1.8V or higher) FM IF detector IC for the electronic tuning system.

Features

- Low-voltage operation (1.8V or higher)
- Supports electronic tuning systems (provides built-in SD output and IF count output functions)
- FM detector circuit accepts an even wider input frequency range. (Supports the use of an external phase capacitor.)
- Miniature package: SOIC10

Functions

- IF amplifier
- Quadrature detector
- Signal meter
- SD
- IF buffer

Specifications

Maximum Ratings at Ta = 25°C

Parameter	Symbol	Conditions	Ratings	Unit
Maximum supply voltage	V _{CC} max		9.0	V
Allowable power dissipation	P _d max	Ta ≤ 85°C	100	mW
Operating temperature	T _{opr}		-20 to +85	°C
Storage temperature	T _{stg}		-55 to +150	°C

Stresses exceeding Maximum Ratings may damage the device. Maximum Ratings are stress ratings only. Functional operation above the Recommended Operating Conditions is not implied. Extended exposure to stresses above the Recommended Operating Conditions may affect device reliability.

Operating Conditions at Ta = 25°C

Parameter	Symbol	Conditions	Ratings	Unit
Recommended supply voltage	V _{CC}		3.0	V
Operating supply voltage range	V _{CC} op		1.8 to 8.0	V

LA1225MC

Operating Characteristics at $T_a = 25^\circ\text{C}$, $V_{CC} = 3.0\text{V}$, $f_C = 10.7\text{MHz}$

Parameter	Symbol	Conditions	Ratings			Unit
			min	typ	max	
Current drain	I_{CCO}	No input	3.0	4.0	5.0	mA
Demodulator output	V_O	100dB μV , 100% mod., $f_m = 1\text{kHz}$	70	150	220	mV
Total harmonic distortion	THD	100dB μV , 100% mod., $f_m = 1\text{kHz}$		0.5	0.8	%
Signal-to-noise ratio	S/N	100dB μV , 100% mod., $f_m = 1\text{kHz}$	65	73		dB
3dB sensitivity	-3dBL.S	100dB μV , 100% mod., $f_m = 1\text{kHz}$ output reference, when the input is -3dB	19	28	37	dB μV
SD sensitivity	SDON	0% mod.	35	50	65	dB μV
IF counter buffer output	V_{IFBuff}	100dB μV	90	130	170	mV

Package Dimensions

Unit : mm

3426

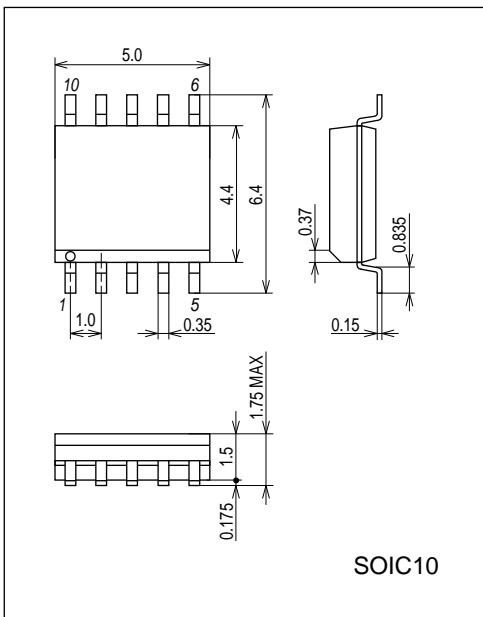

LA1225MC

Block Diagram and Test Circuit

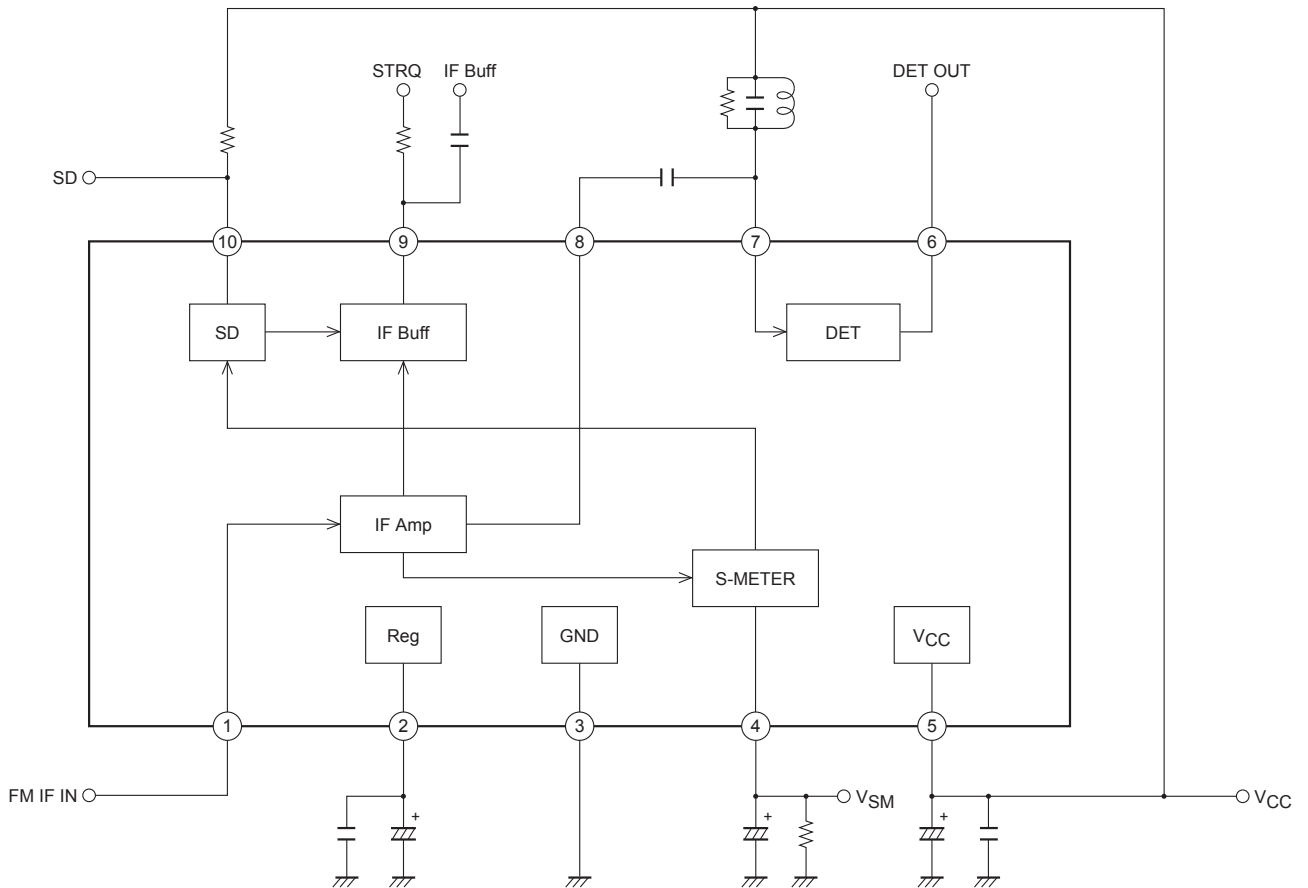

Sample Application Circuit

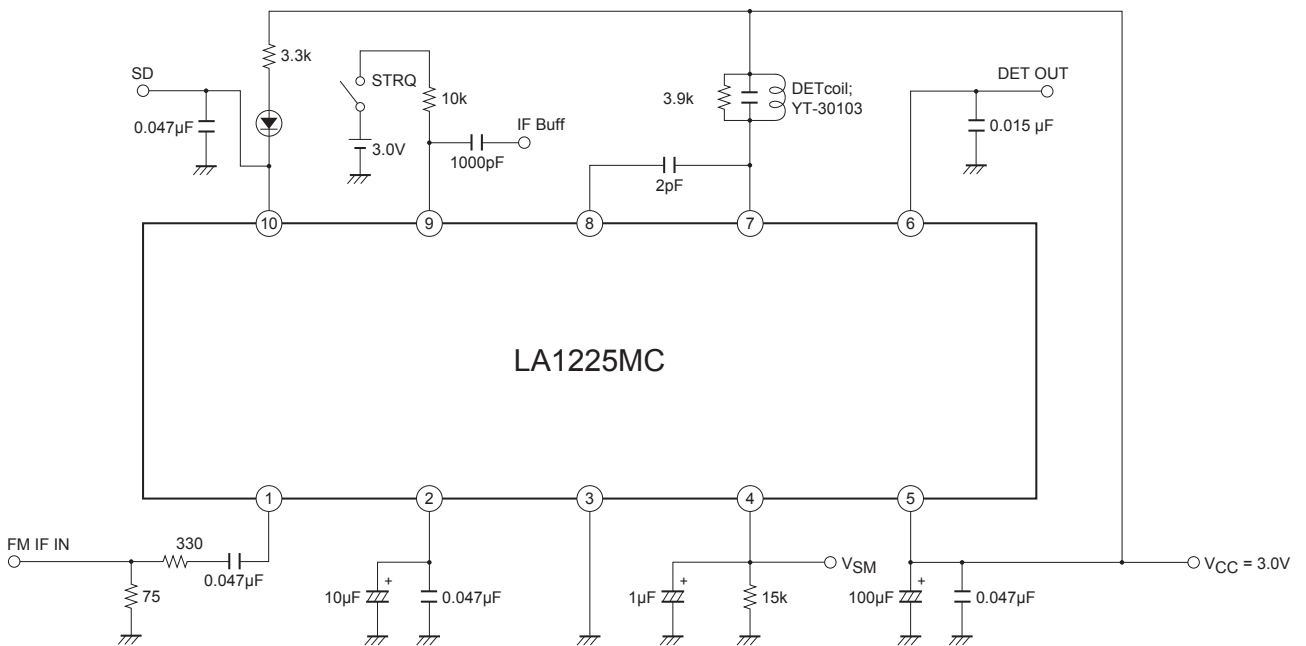

LA1225MC

Pin Functions No-Signal Voltage at $V_{CC} = 3.0V$

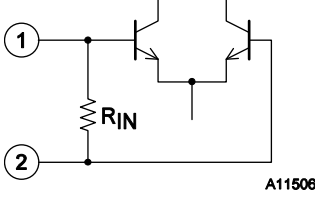
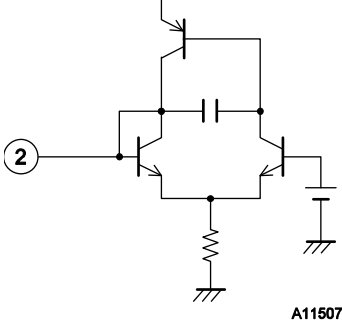
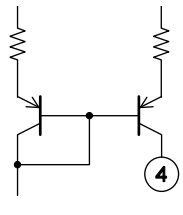
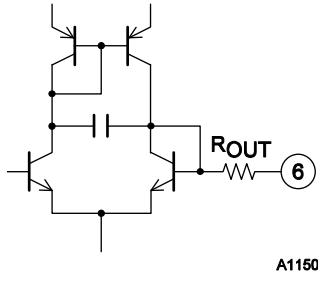
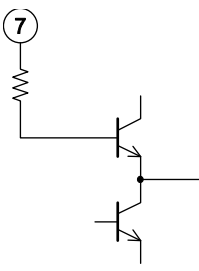
Pin No.	Function	No-signal voltage (V)	Equivalent circuit	Notes
1	IF input	1.2		Input impedance $R_{IN} = 330\Omega$
2	Reg	1.2		$V_{reg} = 1.2V$
3	GND	0		
4	S-meter output	0.1		Open collector output. The SD sensitivity can be adjusted with an external resistor connected to this pin.
5	V_{CC}	3.0		
6	Demodulated output	1.5		Output impedance $R_{OUT} = 3k\Omega$
7	DET	3.0		The detector coil is inserted between pin 7 and pin 5 (V_{CC}).

Continued on next page.

LA1225MC

Continued from preceding page.

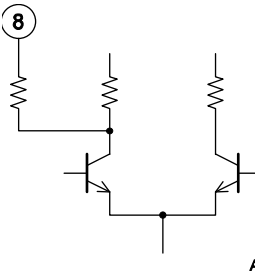
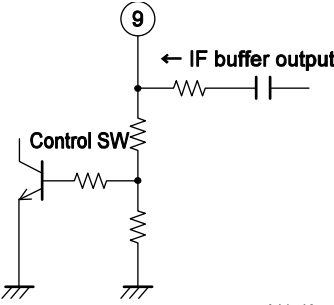
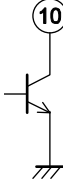
Pin No.	Function	No-signal voltage (V)	Equivalent circuit	Notes
8	Limiter amplifier output	2.8	 <p style="text-align: center;">A11511</p>	Pin 8 and pin 7 (DET) are connected through a capacitor.
9	IF buffer (Also used for control SW)	0	 <p style="text-align: center;">A11512</p>	The IF buffer output is turned on when the voltage applied to the pin is the recommended 1.5V or higher.
10	SD	1.6	 <p style="text-align: center;">A11513</p>	This is an active-low output. This is an open-collector output and can directly drive an LED. ($I_{Cmax} = 20mA$)

LA1225MC

I/O Characteristics

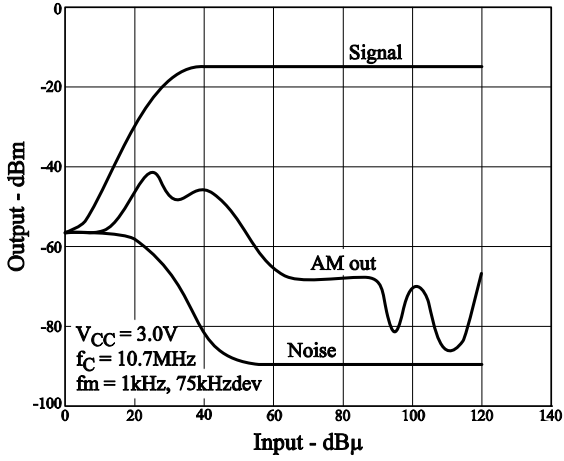

I/O Characteristics

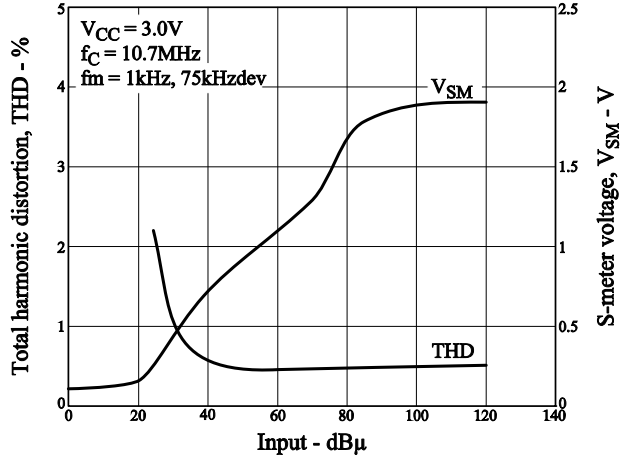

$V_O - V_{CC}$

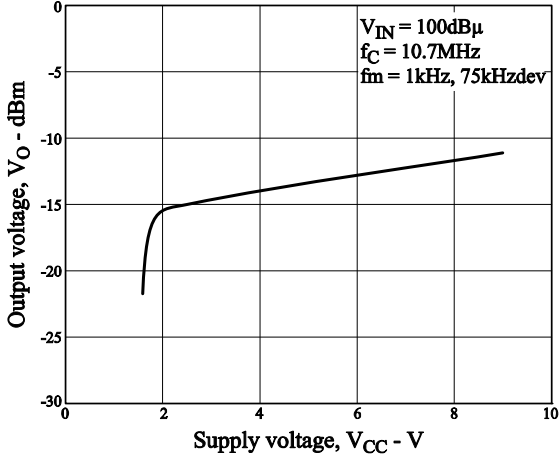

S/N - VCC

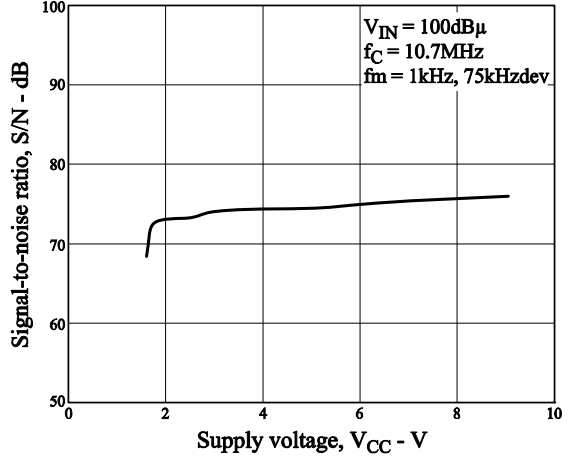

THD - VCC

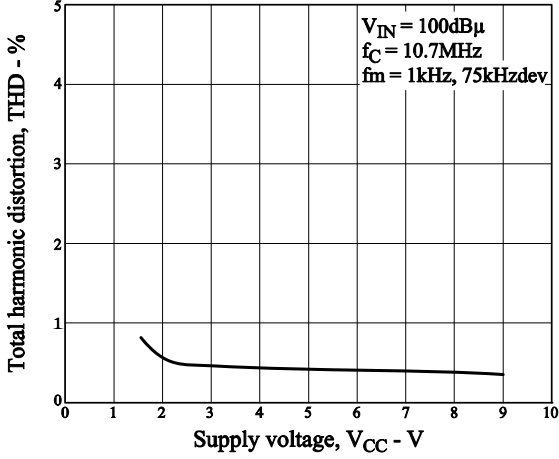

-3dBLS, QS - VCC

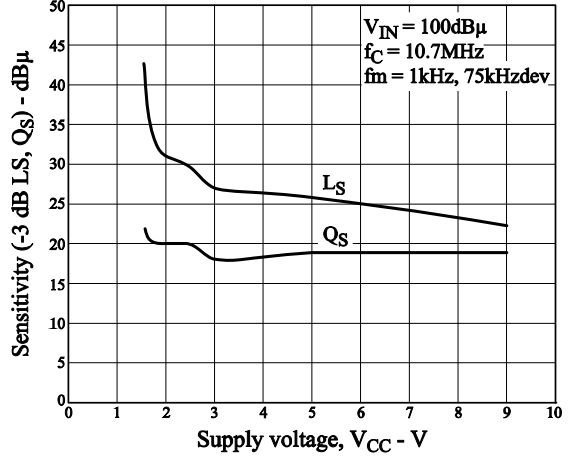

SDON - VCC

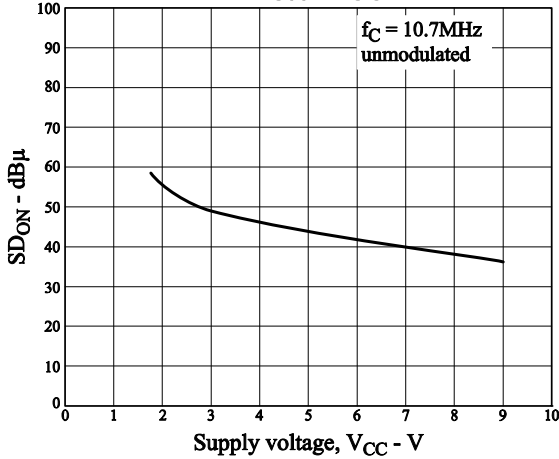

VIFBuff - VCC

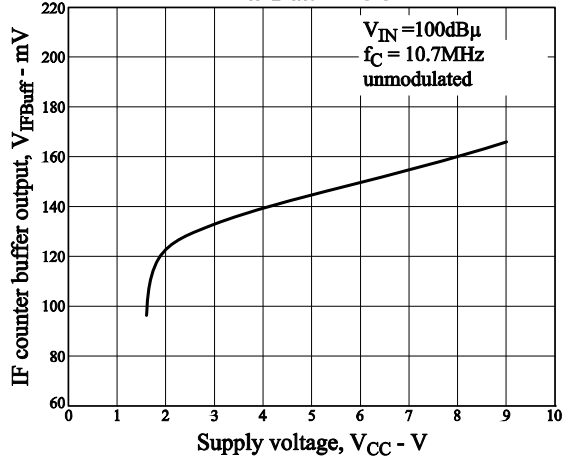

LA1225MC

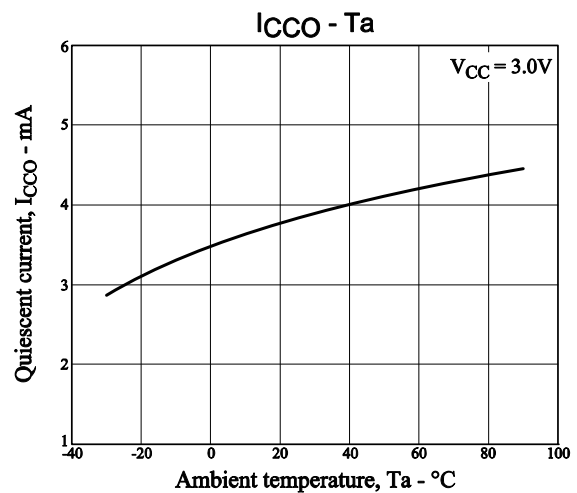
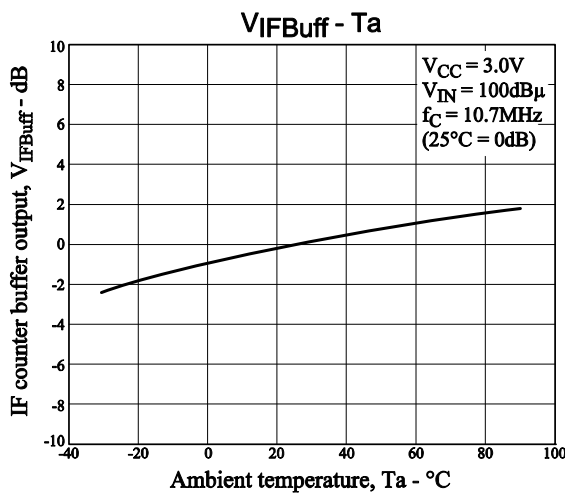
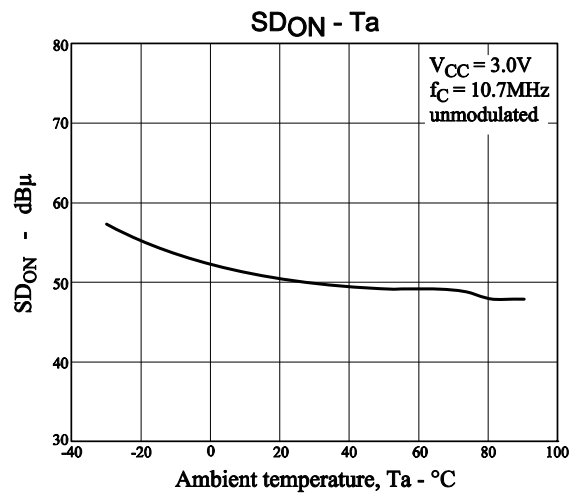
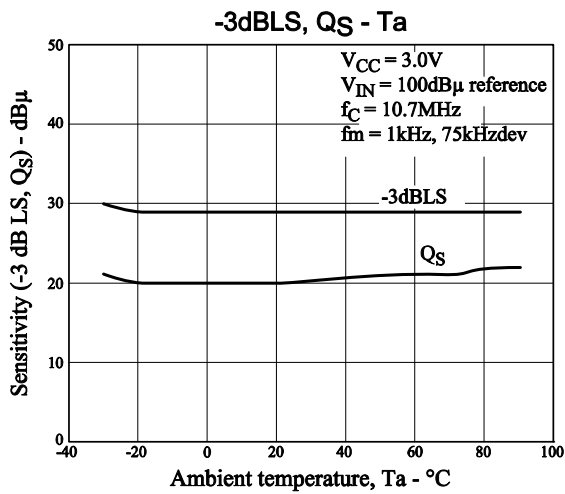
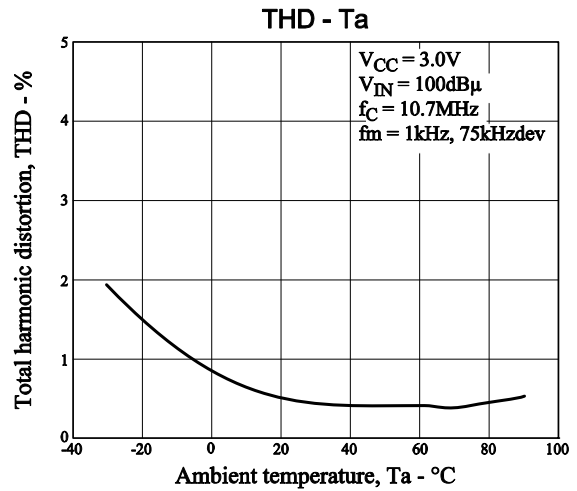
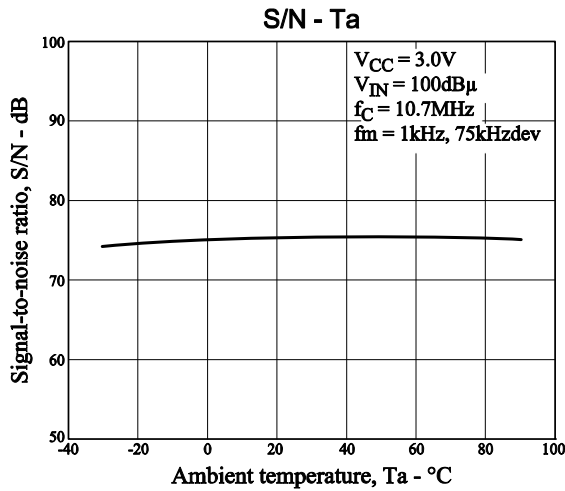
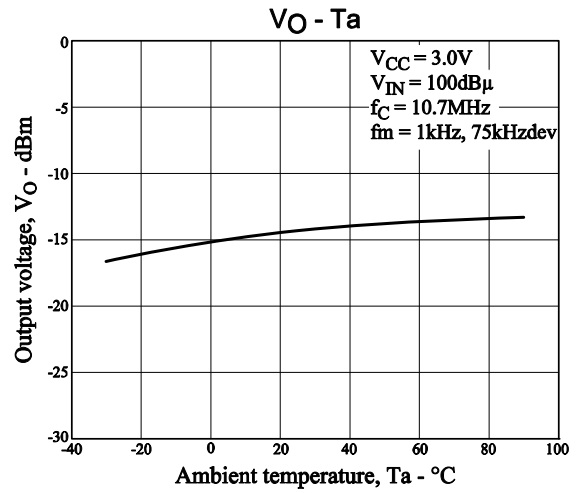
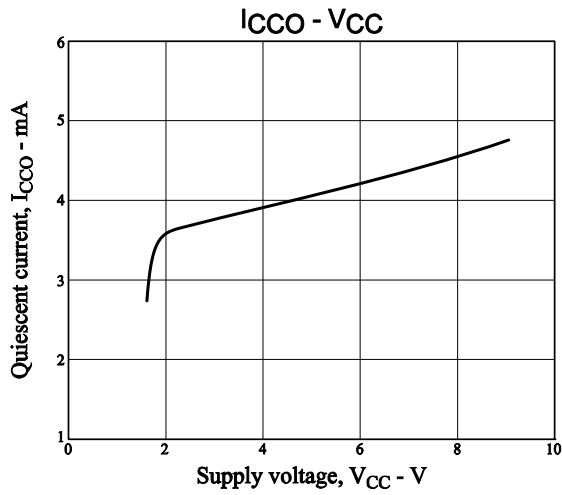

ON Semiconductor and the ON logo are registered trademarks of Semiconductor Components Industries, LLC (SCILLC). SCILLC owns the rights to a number of patents, trademarks, copyrights, trade secrets, and other intellectual property. A listing of SCILLC's product/patent coverage may be accessed at www.onsemi.com/site/pdf/Patent-Marking.pdf. SCILLC reserves the right to make changes without further notice to any products herein. SCILLC makes no warranty, representation or guarantee regarding the suitability of its products for any particular purpose, nor does SCILLC assume any liability arising out of the application or use of any product or circuit, and specifically disclaims any and all liability, including without limitation special, consequential or incidental damages. "Typical" parameters which may be provided in SCILLC data sheets and/or specifications can and do vary in different applications and actual performance may vary over time. All operating parameters, including "Typicals" must be validated for each customer application by customer's technical experts. SCILLC does not convey any license under its patent rights nor the rights of others. SCILLC products are not designed, intended, or authorized for use as components in systems intended for surgical implant into the body, or other applications intended to support or sustain life, or for any other application in which the failure of the SCILLC product could create a situation where personal injury or death may occur. Should Buyer purchase or use SCILLC products for any such unintended or unauthorized application, Buyer shall indemnify and hold SCILLC and its officers, employees, subsidiaries, affiliates, and distributors harmless against all claims, costs, damages, and expenses, and reasonable attorney fees arising out of, directly or indirectly, any claim of personal injury or death associated with such unintended or unauthorized use, even if such claim alleges that SCILLC was negligent regarding the design or manufacture of the part. SCILLC is an Equal Opportunity/Affirmative Action Employer. This literature is subject to all applicable copyright laws and is not for resale in any manner.