

Specification Status: Released

BENEFITS

- ESD protection for high frequency applications
- Smaller form factor for board space savings
- Helps protect electronic circuits against damage from electrostatic discharge (ESD) events
- Assists equipment to pass IEC 61000-4-2, level 4 testing

FEATURES

- 0.25 pF (typ) Capacitance
- Low leakage current
- Low clamping voltage
- Fast response time (<1ns)
- Capable of withstanding numerous ESD strikes
- Compatible with standard reflow installation procedures
- Thick film technology
- Bi-directional protection

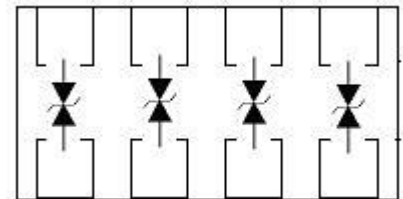
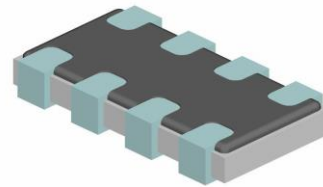

APPLICATIONS

Cellular phones

CAUTION: This device should not be used in Power Bus applications

MATERIALS INFORMATION

RoHS Compliant

Directive 2002/95/EC
 Compliant

ELV Compliant

Directive 2000/53/EC
 Compliant

Halogen Free* **Lead Free**



PART NUMBERING

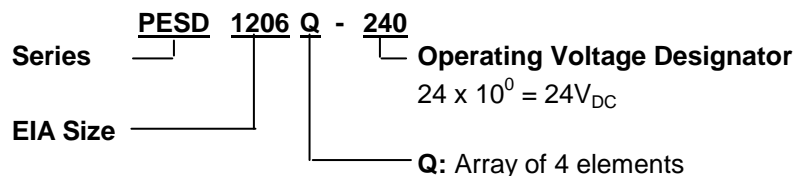

* Halogen Free refers to: **Br**≤900ppm, **Cl**≤900ppm, **Br+Cl**≤1500ppm



Expertise Applied | Answers Delivered

ESD Protector Overvoltage Protection Device

PRODUCT : PESD1206Q-240

DOCUMENT : SCD27553
 REV LETTER : F
 REV DATE: JULY 26, 2016
 PAGE NO.: 2 OF 9

TYPICAL DEVICE RATINGS AND CHARACTERISTICS

	Continuous Max Operating Voltage	Typical TLP Trigger Voltage ¹	Typical TLP Clamping Voltage ¹ after 30ns	Typical Capacitance ² , @ 1 MHz, 1V _{rms}	Typical Leakage Current @24V _{DC}	Max Leakage Current @24V _{DC}
Symbol	V _{DC}	V _{T(TLP)}	V _{C(TLP 30)}	Cp	I _{L(Typ)}	I _{L(MAX)}
Unit	V	V	V	pF	μA	μA
Value	24	250	45	0.25	<0.01	10.0

Note 1: TLP test method @ 1000V (refer to Fig. 5 on page 5)

Note 2: Typical capacitance @ 0V and 24V bias

GENERAL CHARACTERISTICS

Operating temperature: -55°C to +125°C

Storage temperature: -55°C to +125°C

ESD voltage capability (tested per IEC 61000-4-2)

- Contact discharge mode: 8kV (typ), 15kV (max)
- Air discharge mode: 15kV (typ), 25kV (max) [1 pulse: per customer request]

ESD pulse withstand: Typically 100 pulses (tested per IEC 61000-4-2, level 4, and contact method)

Environmental Specifications

	Bias Humidity Test	Thermal Shock	Bias Heat Test	Bias Low Temp Test	Solderability	Solder Heat	Vibration	Mechanical Shock	Solvent Resistance
Test Conditions	@ 85°C @ 85% RH V _{DC} (max) 1000 hours	-55°C to 125°C 30min dwell 1000 cycles	@ 125°C V _{DC} (max) 1000 hours	@ -55°C V _{DC} (max) 1000 hours	250 °C +/- 5 °C 3s +/- 1s	260 °C, 10s	10 to 50Hz, 60s cycle, 2hrs each in X-Y-Z axis	1500G, 0.5ms, X-Y-Z axis 3 times	IPA ultrasonic 300s
Pass/Fail Criteria	I _L ≤ 10μA	I _L ≤ 10μA	I _L ≤ 10μA	I _L ≤ 10μA	95% coverage	90% coverage	No Physical Damage I _L ≤ 10 μA	No Physical Damage I _L ≤ 10 μA	No Physical Damage I _L ≤ 10 μA

FIG 1: CAPACITANCE VS. FREQUENCY (TYPICAL SAMPLE)
 (PESD1206Q Flat Response of Capacitance over Frequency Range)

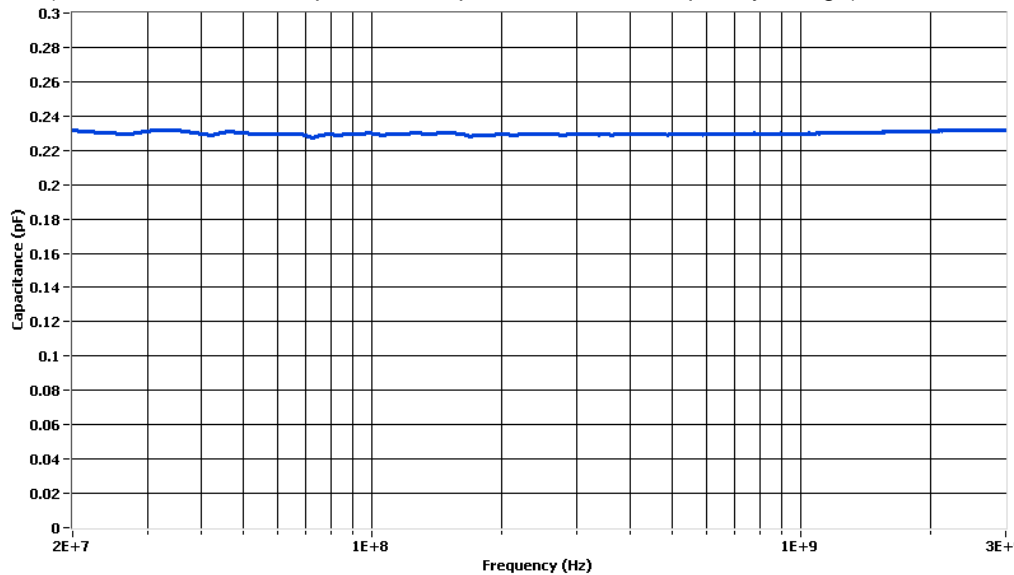

FIG 2: EYE DIAGRAM (TYPICAL SAMPLE)
 (PESD1206Q Eye Diagram Performance at 3.4 GHz)

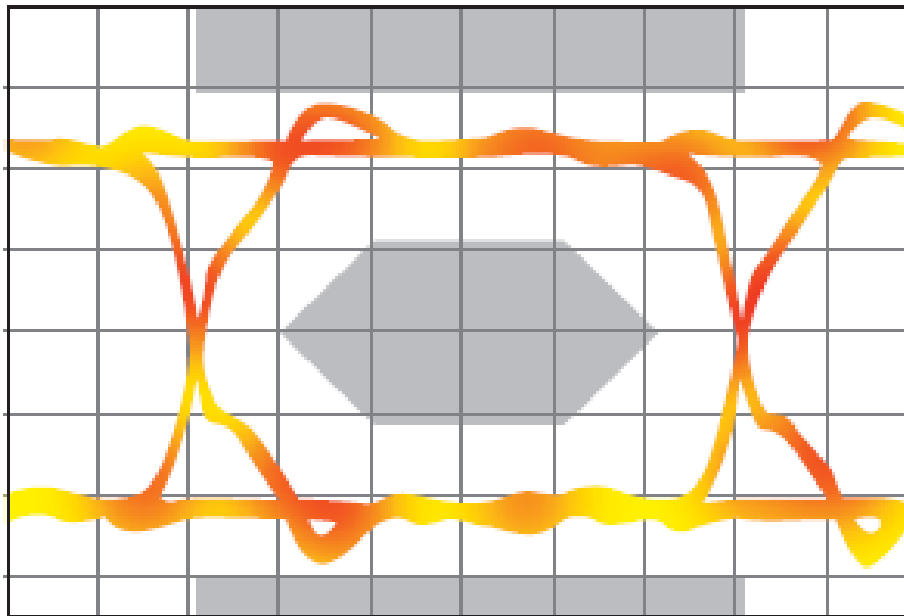

FIG 3: INSERTION LOSS DIAGRAM (TYPICAL SAMPLE)
 (PESD1206Q Minimal Insertion Loss at 3.4 GHz)

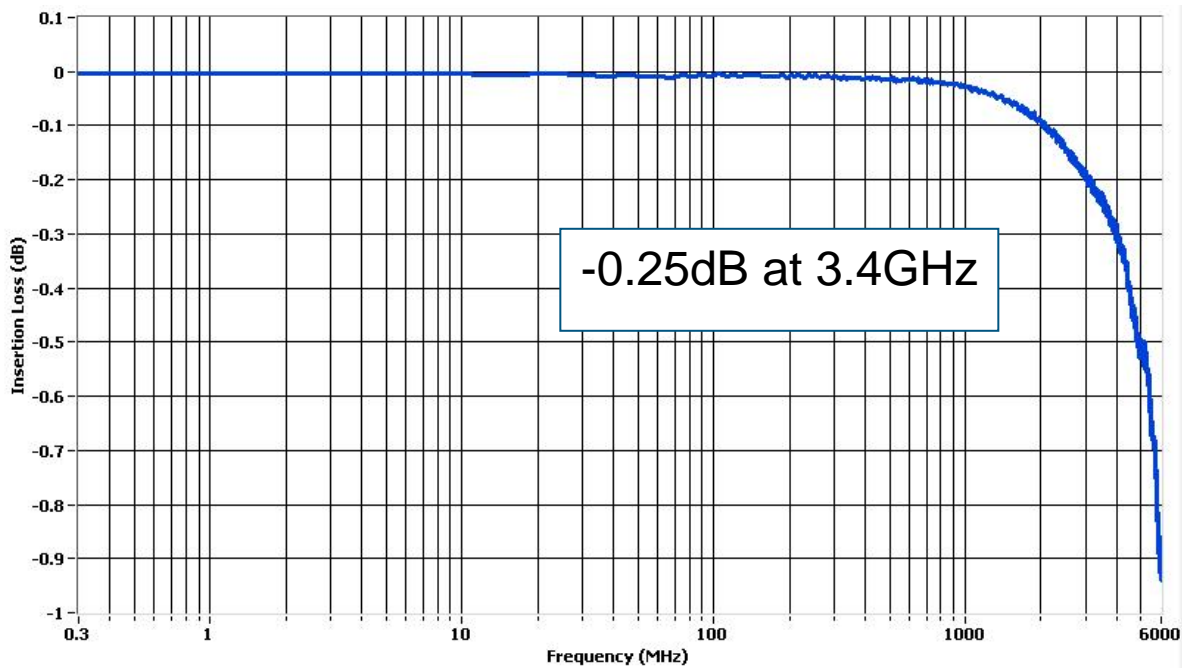

FIG 4: ESD PROTECTION FOR HDMI

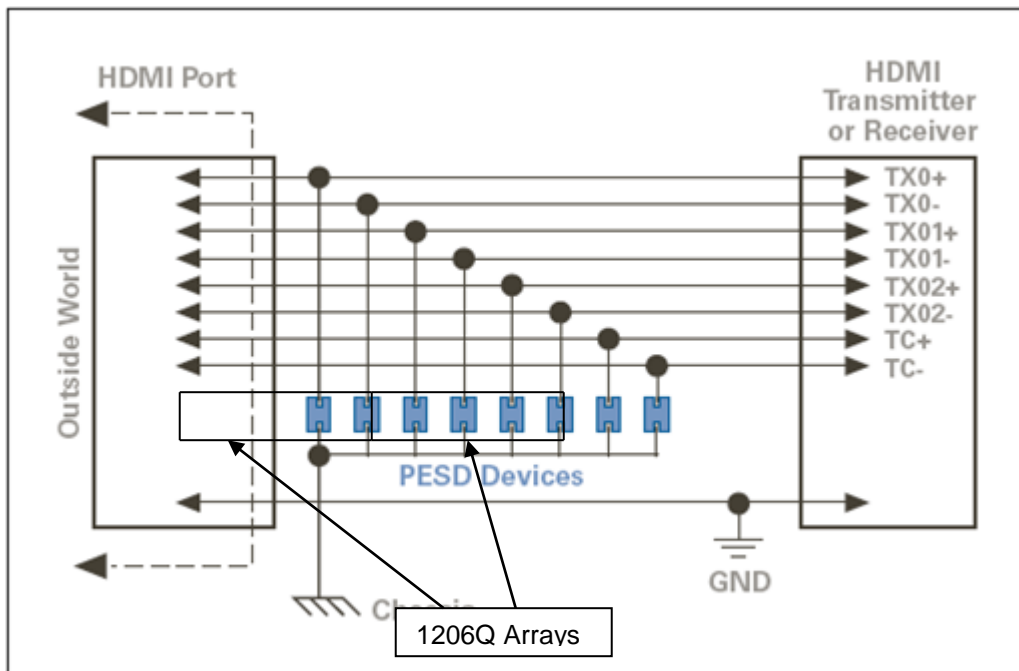
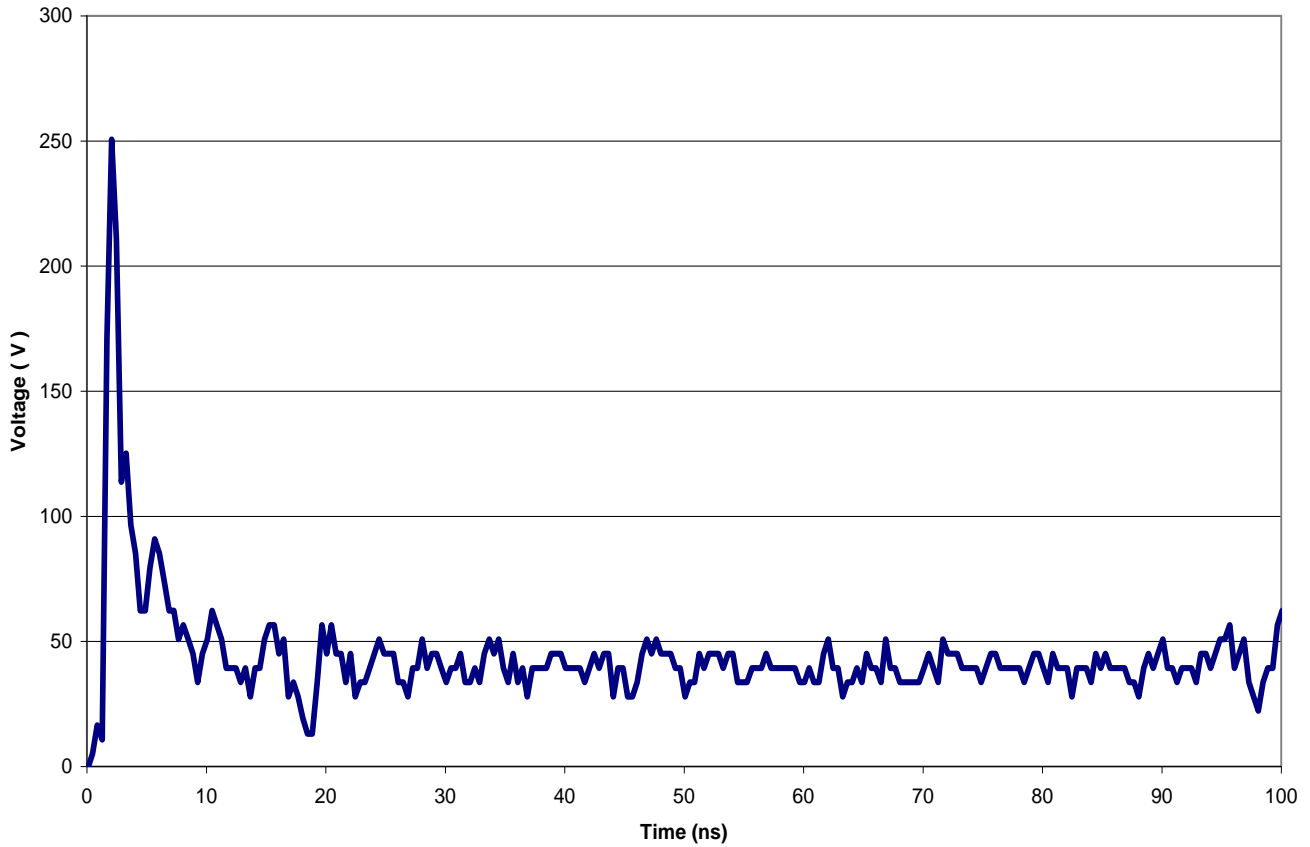
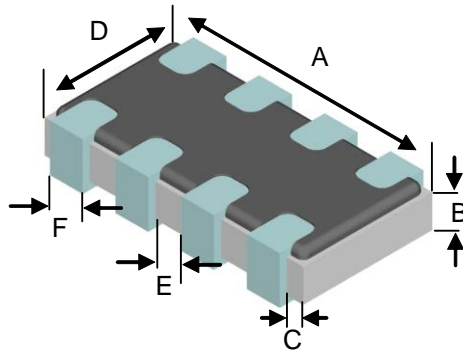

FIG 5: TYPICAL TRANSMISSION LINE PULSE RESPONSE GRAPH

Typical TLP Clamping Voltage



DIMENSIONS



Drawing Not To Scale

	Length A		Height B		End Terminal Width C		Length Width D		Length Width E		Length Width F	
	Min	Max	Min	Max	Min	Max	Min	Max	Min	Max	Min	Max
mm:	3.1	3.3	0.4	0.6	0.1	0.3	1.5	1.7	0.2	0.6	0.2	0.6
in*:	(0.122)	(0.130)	(0.016)	(0.024)	(0.004)	(0.012)	(0.059)	(0.067)	(0.008)	(0.024)	(0.008)	(0.024)

* Round off approximation

RECOMMENDED LAND PATTERN:

Solder thickness 0.15 to 0.2 mm

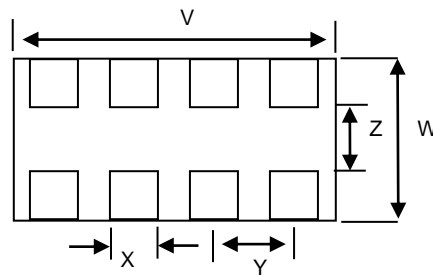

	V	W	X	Y	Z
	Typ	Typ	Typ	Typ	Typ
mm:	3.2	2.2	0.5	0.8	1.0
in*:	(0.126)	(0.087)	(0.020)	(0.031)	(0.039)

* Round off approximation



Expertise Applied | Answers Delivered

ESD Protector Overvoltage Protection Device

PRODUCT : PESD1206Q-240

DOCUMENT : SCD27553
REV LETTER : F
REV DATE: JULY 26, 2016
PAGE NO.: 7 OF 9

SOLDER REFLOW RECOMMENDATIONS:

A	Temperature ramp up 1	From ambient to Preheating temperature	30s to 60s
B	Preheating	140°C - 160°C	60s to 120s
C	Temperature ramp up 2	From Preheating to Main heating temperature	20s to 40s
D	Main heating	at 200°C at 220°C at 240°C at 260°C	60s ~ 70s 50s ~ 60s 30s ~ 40s 5s ~ 10s
E	Cooling	From main heating temperature to 100°C	max 4°C/s

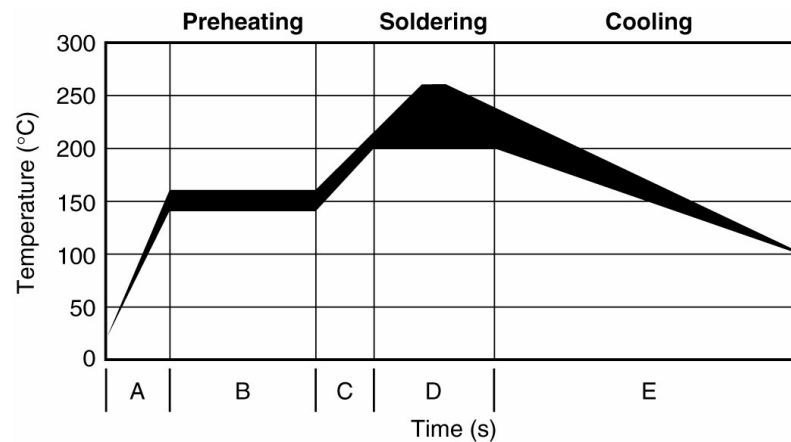

PACKAGING

Packaging	Tape & Reel	Standard Box
PESD1206Q-240	5,000	25,000

EIA referenced Reel Dimensions for PESD Devices

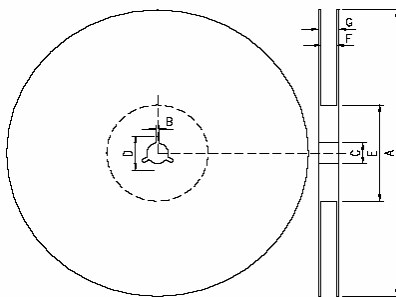

Reel Dimensions (mm):

	A	B	C	D	E	F	G
1206 Devices	178.0 ±2.0	2.0 ±0.5	13.0±0.5	21.0±0.8	62.0±1.5	9.0±0.5	13.0±1.0

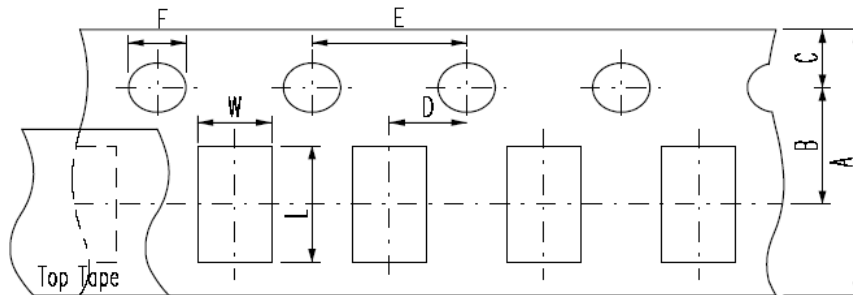

Carrier Dimensions (mm):

	A	B	C	D	E	F	L	W	T ¹
1206 Devices	8.0±0.3	3.5±0.05	1.75±0.1	2.0±0.05	4.0±0.1	1.5±0.1	3.62±0.20	2.02±0.20	0.75±0.05

Note 1: Carrier thickness

Product Orientation – always face up (meaning the substrate is at the bottom), but parts do not have polarity mark.



Expertise Applied | Answers Delivered

ESD Protector Overvoltage Protection Device

PRODUCT : PESD1206Q-240

DOCUMENT : SCD27553
REV LETTER : F
REV DATE: JULY 26, 2016
PAGE NO.: 9 OF 9

POST REFLOW, CLEANING CONDITIONS

A 5% saponifier combined with water during wash.

For the ultrasonic process water temperature should be at 50°C and board should be submerged for a minimum of one minute in the solutions, then rinse and dry.

For in-line washing, the temperature of the water sprayed should be at 110°C, rinse and drying is done in-line.



WARNING

Warning: Application Limitations for PESD1206Q-240. This part is not intended to be used on power lines or for power bus applications. Users should independently evaluate the suitability of and test each product selected for their own applications

Information furnished is believed to be accurate and reliable. However, users should independently evaluate the suitability of and test each product selected for their own applications. Littelfuse products are not designed for, and shall not be used for, any purpose (including, without limitation, military, aerospace, medical, lifesaving, life-sustaining or nuclear facility applications, devices intended for surgical implant into the body, or any other application in which the failure or lack of desired operation of the product may result in personal injury, death, or property damage) other than those expressly set forth in applicable Littelfuse product documentation. Warranties granted by Littelfuse shall be deemed void for products used for any purpose not expressly set forth in applicable Littelfuse documentation. Littelfuse shall not be liable for any claims or damages arising out of products used in applications not expressly intended by Littelfuse as set forth in applicable Littelfuse documentation. The sale and use of Littelfuse products is subject to Littelfuse Terms and Conditions of Sale, unless otherwise agreed by Littelfuse.