

CM1690

Praetorian® L-C LCD and Camera EMI Filter Array with ESD Protection

Product Description

The CM1690 is a family of pi-style EMI filter arrays with ESD protection, which integrates four, six and eight filters (C-L-C) in small form factor μ DFN 0.40 mm pitch packages. Each EMI filter channel of the CM1690 is implemented as a 3-pole L-C filter where the component values are 16 pF – 12 nH – 16 pF. The CM1690's roll-off frequency at –6 dB attenuation is 330 MHz and can be used in applications where the data rates are as high as 140 Mbps while providing greater than –35 dB attenuation over the 1.0 GHz to 3.0 GHz frequency range. The parts include ESD diodes on every pin, which provide a very high level of protection for sensitive electronic components that may be subjected to electrostatic discharge (ESD). The ESD protection diodes connected to the filter ports are designed and characterized to safely dissipate ESD strikes of ± 15 kV, beyond the maximum requirement of the IEC61000-4-2 international standard. Using the MIL-STD-883 (Method 3015) specification for Human Body Model (HBM) ESD, the pins are protected for contact discharges at greater than ± 30 kV.

This device is particularly well suited for wireless handsets, mobile LCD modules and PDAs because of its small package format and easy-to-use pin assignments. In particular, the CM1690 is ideal for EMI filtering and protecting data and control lines for the LCD display and camera interface in mobile handsets.

The CM1690 is available in space saving, ultra low profile 8-, 12-, and 16-lead 0.40 mm μ DFN packages with lead-free finishing.

Features

- Four, Six and Eight Channels of EMI Filtering with Integrated ESD Protection
- Pi-Style EMI Filters in a Capacitor-Inductor-Capacitor (C-L-C) Network
- ± 15 kV ESD Protection on Each Channel (IEC 61000-4-2 Level 4, Contact Discharge)
- ± 30 kV ESD Protection on Each Channel (HBM)
- Greater than –35 dB Attenuation (Typical) at 1 GHz
- 0.50 mm Thick μ DFN Package with 0.40 mm Lead Pitch:
 - ◆ 4-ch. = 8-lead μ DFN
 - ◆ 6-ch. = 12-lead μ DFN
 - ◆ 8-ch. = 16-lead μ DFN
- Tiny μ DFN Package Size:
 - ◆ 8-lead: 1.70 mm x 1.35 mm
 - ◆ 12-lead: 2.50 mm x 1.35 mm
 - ◆ 16-lead: 3.30 mm x 1.35 mm
- These Devices are Pb-Free and are RoHS Compliant

Applications

- LCD and Camera Data Lines in Mobile Handsets
- Wireless Handsets
- LCD and Camera Modules



ON Semiconductor®

<http://onsemi.com>



UDFN8
DE SUFFIX
CASE 517BC



UDFN12
DE SUFFIX
CASE 517BD



UDFN16
DE SUFFIX
CASE 517BE

ELECTRICAL SCHEMATIC

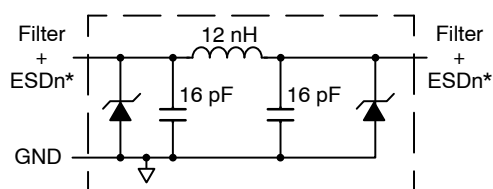

1 of 4, 6 or 8 EMI/RFI Filter Channels
with Integrated ESD Protection

* See Package/Pinout Diagrams for expanded pin information.

MARKING DIAGRAM

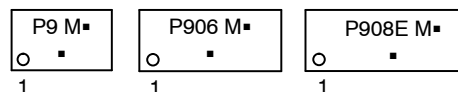

P9 = CM1690-04DE
P906 = CM1690-06DE
P908E = CM1690-08DE
M = Date Code
■ = Pb-Free Package

(Note: Microdot may be in either location)

ORDERING INFORMATION

Device	Package	Shipping†
CM1690-04DE	μ DFN-8 (Pb-Free)	3000/Tape & Reel
CM1690-06DE	μ DFN-12 (Pb-Free)	3000/Tape & Reel
CM1690-08DE	μ DFN-16 (Pb-Free)	3000/Tape & Reel

† For information on tape and reel specifications, including part orientation and tape sizes, please refer to our Tape and Reel Packaging Specification Brochure, BRD8011/D.

CM1690

PACKAGE / PINOUT DIAGRAMS

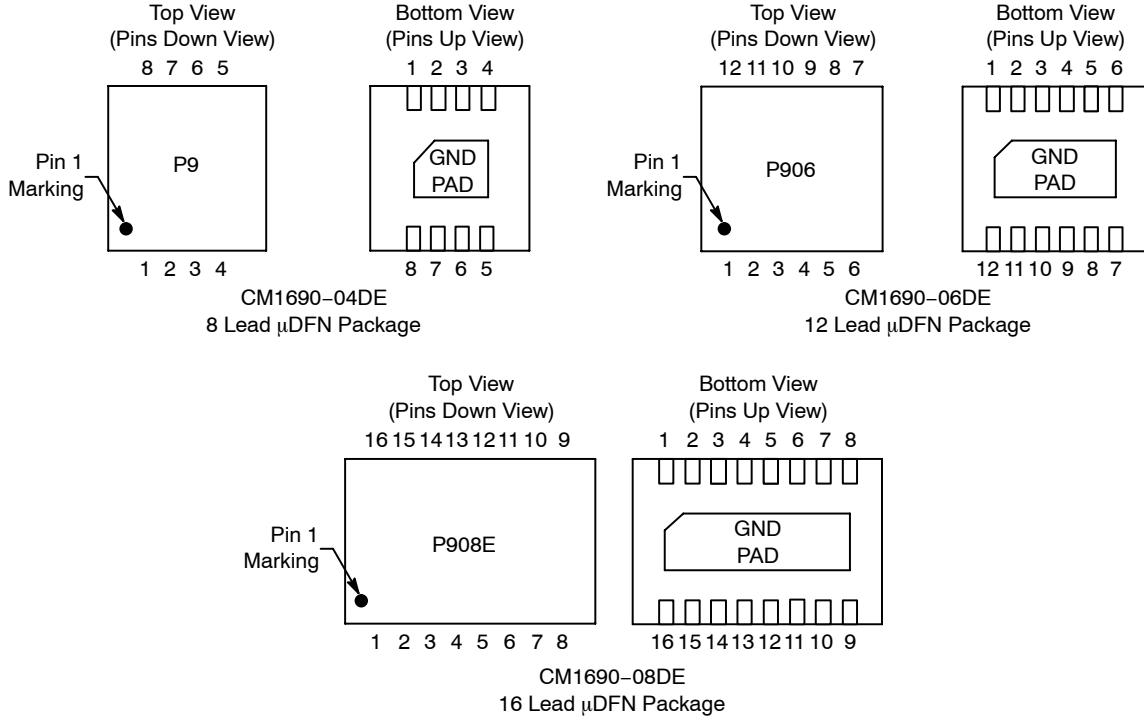

Table 1. PIN DESCRIPTIONS

Device Pin(s)			Name	Description	Device Pin(s)			Name	Description
-04	-06	-08			-04	-06	-08		
1	1	1	FILTER1	Filter + ESD Channel 1	8	12	16	FILTER1	Filter + ESD Channel 1
2	2	2	FILTER2	Filter + ESD Channel 2	7	11	15	FILTER2	Filter + ESD Channel 2
3	3	3	FILTER3	Filter + ESD Channel 3	6	10	14	FILTER3	Filter + ESD Channel 3
4	4	4	FILTER4	Filter + ESD Channel 4	5	9	13	FILTER4	Filter + ESD Channel 4
-	5	5	FILTER5	Filter + ESD Channel 5	-	8	12	FILTER5	Filter + ESD Channel 5
-	6	6	FILTER6	Filter + ESD Channel 6	-	7	11	FILTER6	Filter + ESD Channel 6
-	-	7	FILTER7	Filter + ESD Channel 7	-	-	10	FILTER7	Filter + ESD Channel 7
-	-	8	FILTER8	Filter + ESD Channel 8	-	-	9	FILTER8	Filter + ESD Channel 8
GND PAD			GND	Device Ground	-	-	-	-	

CM1690

SPECIFICATIONS

Table 2. ABSOLUTE MAXIMUM RATINGS

Parameter	Rating	Units
Storage Temperature Range	-65 to +150	°C
Current per Inductor	30	mA
DC Package Power Rating	500	mW

Stresses exceeding Maximum Ratings may damage the device. Maximum Ratings are stress ratings only. Functional operation above the Recommended Operating Conditions is not implied. Extended exposure to stresses above the Recommended Operating Conditions may affect device reliability.

Table 3. STANDARD OPERATING CONDITIONS

Parameter	Rating	Units
Operating Temperature Range	-40 to +85	°C

Table 4. ELECTRICAL OPERATING CHARACTERISTICS (Note 1)

Symbol	Parameter	Conditions	Min	Typ	Max	Units
L	Channel Inductance			12		nH
C _{TOTAL}	Total Channel Capacitance	At 2.5 V DC Reverse Bias, 1 MHz, 30 mV AC	25	33	40	pF
C	Capacitance C1	At 2.5 V DC Reverse Bias, 1 MHz, 30 mV AC		16.5		pF
V _{DIODE}	Stand-off Voltage	I _{DIODE} = 10 μA		6.0		V
I _{LEAK}	Diode Leakage Current (Reverse Bias)	V _{DIODE} = 3.3 V		0.1	0.3	μA
V _{SIG}	Signal Clamp Voltage Positive Clamp Negative Clamp	I _{LOAD} = 10 mA I _{LOAD} = -10 mA (Note 3)	5.6 -1.5	6.8 -0.8	9.0 -0.4	V
V _{ESD}	In-system ESD Withstand Voltage a) Human Body Model, MIL-STD-883, Method 3015 b) Contact Discharge per IEC 61000-4-2 Level 4	(Notes 2 and 4)	±30 ±15			kV
R _{DYN}	Dynamic Resistance Positive Negative			2.3 0.9		Ω
f _C	Roll-off Frequency at -6 dB Attenuation Z _{SOURCE} = 50 Ω, Z _{LOAD} = 50 Ω			330		MHz
R _{INSULATION}	Insulation Resistance	V _{DIODE} = 3.3 V (Note 4)	10			MΩ
R _{CHANNEL}	Channel Resistance			8		Ω

1. T_A = 25°C unless otherwise specified.

2. ESD applied to input and output pins with respect to GND, one at a time.

3. Clamping voltage is measured at the opposite side of the EMI filter to the ESD pin (i.e. if ESD is applied to pin A1 then clamping voltage is measured at pin C1).

4. Unused pins are left open.

CM1690

PERFORMANCE INFORMATION

Typical Diode Capacitance vs. Input Voltage

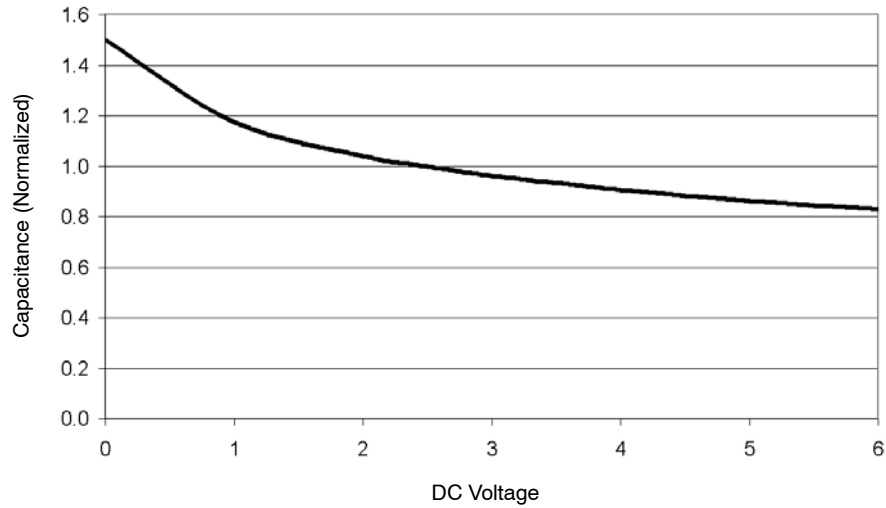

Figure 1. Filter Capacitance vs. Input Voltage (normalized to capacitance at 2.5 V DC and 25°C)

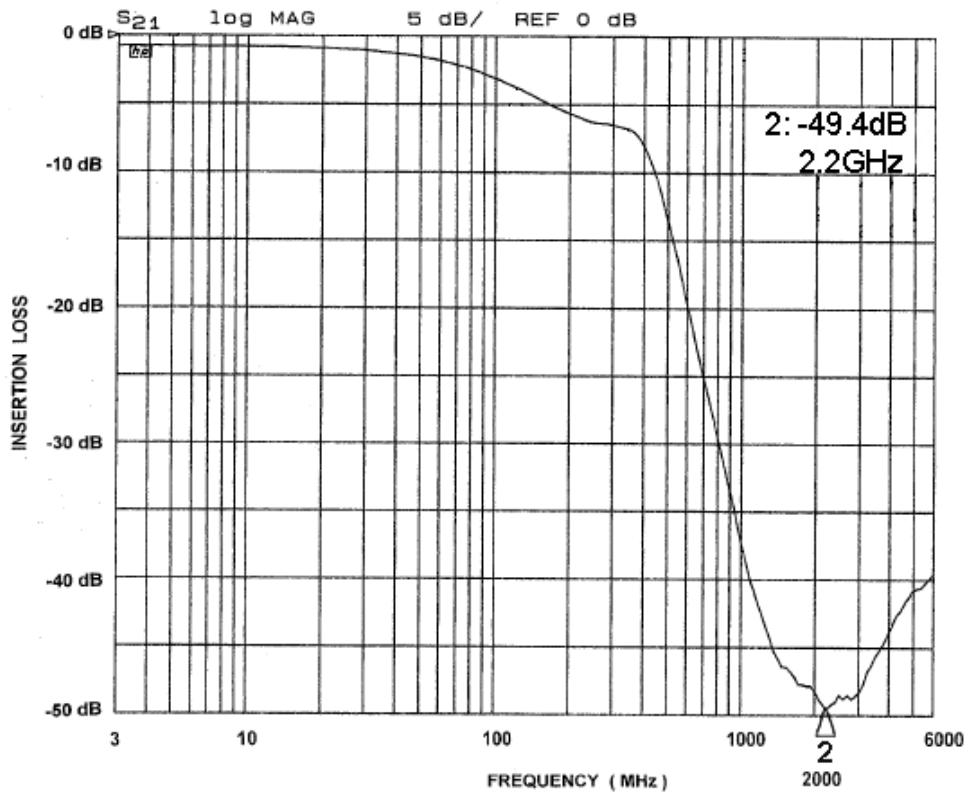

Figure 2. Typical Performance Curve

MECHANICAL CASE OUTLINE PACKAGE DIMENSIONS



SCALE 4:1

UDFN8, 1.7x1.35, 0.4P
CASE 517BC
ISSUE A

DATE 11 AUG 2022

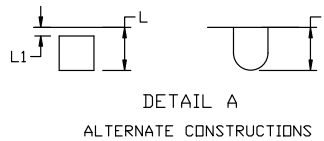
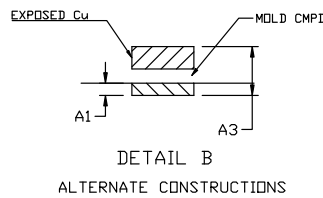
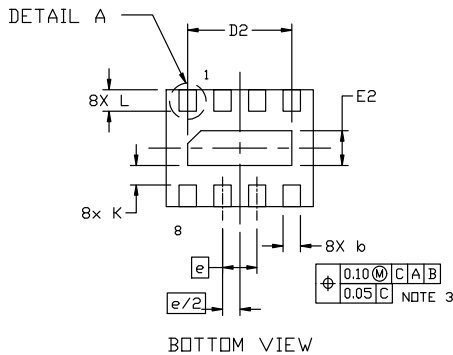
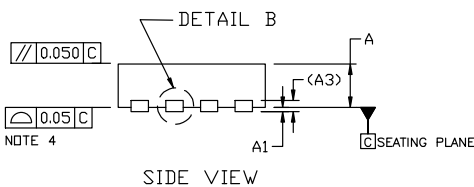
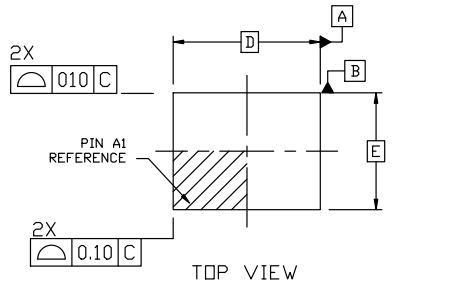

NOTES:

1. DIMENSIONING AND TOLERANCING PER ASME Y14.5M, 2004.
2. CONTROLLING DIMENSION: MILLIMETERS.
3. DIMENSION b APPLIES TO PLATED TERMINAL AND IS MEASURED BETWEEN 0.15 AND 0.25MM FROM THE TERMINAL TIP.
4. COPLANARITY APPLIES TO THE EXPOSED PADS AS WELL AS THE TERMINALS.

DIM	MILLIMETERS	
	MIN.	MAX.
A	0.45	0.55
A1	0.00	0.05
A3	0.13 REF	
b	0.15	0.25
D	1.70 BSC	
D2	1.10	1.30
E	1.35 BSC	
E2	0.30	0.50
e	0.40 BSC	
K	0.15	---
L	0.20	0.30
L1	---	0.05

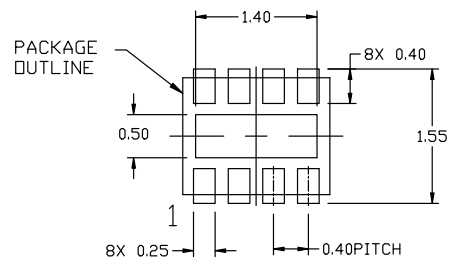

GENERIC MARKING DIAGRAMS*



- XXX = Specific Device Code
- M = Date Code
- = Pb-Free Package

(Note: Microdot may be in either location)

*This information is generic. Please refer to device data sheet for actual part marking. Pb-Free indicator, "G" or microdot "▪", may or may not be present. Some products may not follow the Generic Marking.

* For additional information on our Pb-Free strategy and soldering details, please download the [EN Semiconductor Soldering and Mounting Techniques Reference Manual, SOLDERM/D](#).

DOCUMENT NUMBER:	98AON47060E	Electronic versions are uncontrolled except when accessed directly from the Document Repository. Printed versions are uncontrolled except when stamped "CONTROLLED COPY" in red.
DESCRIPTION:	UDFN8, 1.7x1.35, 0.4P	PAGE 1 OF 1

onsemi and onsemi are trademarks of Semiconductor Components Industries, LLC dba onsemi or its subsidiaries in the United States and/or other countries. onsemi reserves the right to make changes without further notice to any products herein. onsemi makes no warranty, representation or guarantee regarding the suitability of its products for any particular purpose, nor does onsemi assume any liability arising out of the application or use of any product or circuit, and specifically disclaims any and all liability, including without limitation special, consequential or incidental damages. onsemi does not convey any license under its patent rights nor the rights of others.

MECHANICAL CASE OUTLINE

PACKAGE DIMENSIONS

ON Semiconductor®



UDFN12, 2.5x1.35, 0.4P
CASE 517BD-01
ISSUE O

DATE 18 NOV 2009

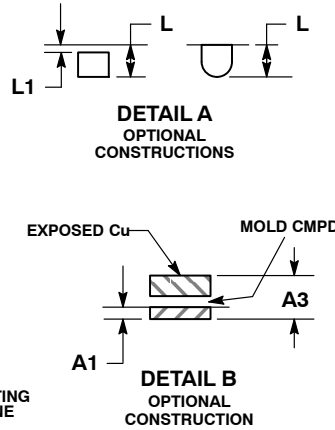

- NOTES:
1. DIMENSIONING AND TOLERANCING PER ASME Y14.5M, 1994.
 2. CONTROLLING DIMENSION: MILLIMETERS.
 3. DIMENSION b APPLIES TO PLATED TERMINAL AND IS MEASURED BETWEEN 0.15 AND 0.25 mm FROM THE TERMINAL TIP.
 4. COPLANARITY APPLIES TO THE EXPOSED PAD AS WELL AS THE TERMINALS.

MILLIMETERS		
DIM	MIN	MAX
A	0.45	0.55
A1	0.00	0.05
A3	0.13	REF
b	0.15	0.25
D	2.50	BSC
D2	1.90	2.10
E	1.35	BSC
E2	0.30	0.50
e	0.40	BSC
K	0.15	---
L	0.20	0.30
L1	---	0.05

GENERIC MARKING DIAGRAM*

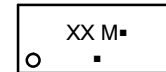

1

- XX = Specific Device Code
- M = Month Code
- = Pb-Free Package

(Note: Microdot may be in either location)

*This information is generic. Please refer to device data sheet for actual part marking.

Pb-Free indicator, "G" or microdot "■", may or may not be present.

RECOMMENDED SOLDERING FOOTPRINT*

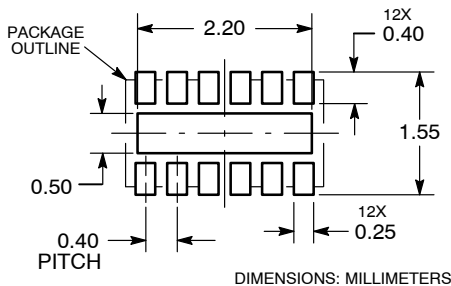

*For additional information on our Pb-Free strategy and soldering details, please download the ON Semiconductor Soldering and Mounting Techniques Reference Manual, SOLDERRM/D.

DOCUMENT NUMBER:	98AON47061E	Electronic versions are uncontrolled except when accessed directly from the Document Repository. Printed versions are uncontrolled except when stamped "CONTROLLED COPY" in red.
DESCRIPTION:	UDFN12, 2.5X1.35, 0.4P	PAGE 1 OF 1

ON Semiconductor and ON are trademarks of Semiconductor Components Industries, LLC dba ON Semiconductor or its subsidiaries in the United States and/or other countries. ON Semiconductor reserves the right to make changes without further notice to any products herein. ON Semiconductor makes no warranty, representation or guarantee regarding the suitability of its products for any particular purpose, nor does ON Semiconductor assume any liability arising out of the application or use of any product or circuit, and specifically disclaims any and all liability, including without limitation special, consequential or incidental damages. ON Semiconductor does not convey any license under its patent rights nor the rights of others.

MECHANICAL CASE OUTLINE

PACKAGE DIMENSIONS

ON Semiconductor®

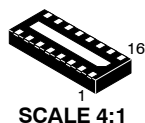

UDFN16, 3.3x1.35, 0.4P
CASE 517BE-01
ISSUE O

DATE 18 NOV 2009

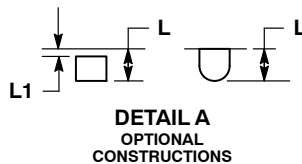
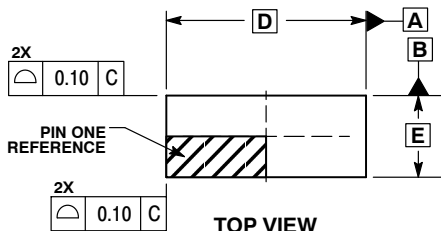

- NOTES:
1. DIMENSIONING AND TOLERANCING PER ASME Y14.5M, 1994.
 2. CONTROLLING DIMENSION: MILLIMETERS.
 3. DIMENSION b APPLIES TO PLATED TERMINAL AND IS MEASURED BETWEEN 0.15 AND 0.25 mm FROM THE TERMINAL TIP.
 4. COPLANARITY APPLIES TO THE EXPOSED PAD AS WELL AS THE TERMINALS.

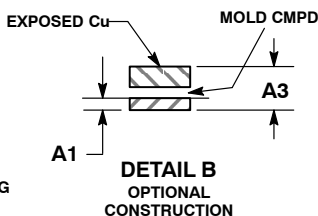
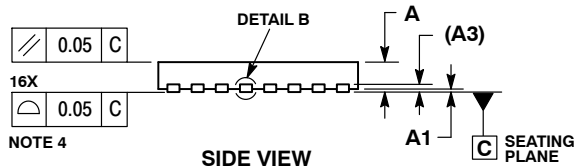

MILLIMETERS		
DIM	MIN	MAX
A	0.45	0.55
A1	0.00	0.05
A3	0.13	REF
b	0.15	0.25
D	3.30	BSC
D2	2.70	2.90
E	1.35	BSC
E2	0.30	0.50
e	0.40	BSC
K	0.15	---
L	0.20	0.30
L1	---	0.05

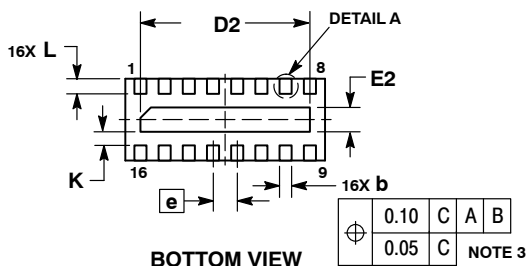

GENERIC MARKING DIAGRAM*

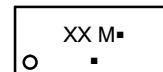

1

- XX = Specific Device Code
- M = Month Code
- = Pb-Free Package

(Note: Microdot may be in either location)

*This information is generic. Please refer to device data sheet for actual part marking.

Pb-Free indicator, "G" or microdot "▪", may or may not be present.

RECOMMENDED SOLDERING FOOTPRINT*

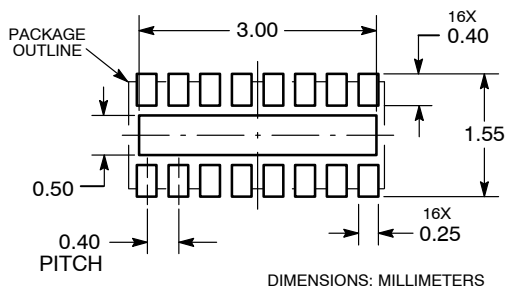

*For additional information on our Pb-Free strategy and soldering details, please download the ON Semiconductor Soldering and Mounting Techniques Reference Manual, SOLDERRM/D.

DOCUMENT NUMBER:	98AON47062E	Electronic versions are uncontrolled except when accessed directly from the Document Repository. Printed versions are uncontrolled except when stamped "CONTROLLED COPY" in red.
DESCRIPTION:	UDFN16, 3.3X1.35, 0.4P	PAGE 1 OF 1

ON Semiconductor and are trademarks of Semiconductor Components Industries, LLC dba ON Semiconductor or its subsidiaries in the United States and/or other countries. ON Semiconductor reserves the right to make changes without further notice to any products herein. ON Semiconductor makes no warranty, representation or guarantee regarding the suitability of its products for any particular purpose, nor does ON Semiconductor assume any liability arising out of the application or use of any product or circuit, and specifically disclaims any and all liability, including without limitation special, consequential or incidental damages. ON Semiconductor does not convey any license under its patent rights nor the rights of others.

onsemi, **Onsemi**, and other names, marks, and brands are registered and/or common law trademarks of Semiconductor Components Industries, LLC dba "**onsemi**" or its affiliates and/or subsidiaries in the United States and/or other countries. **onsemi** owns the rights to a number of patents, trademarks, copyrights, trade secrets, and other intellectual property. A listing of **onsemi**'s product/patent coverage may be accessed at www.onsemi.com/site/pdf/Patent-Marking.pdf. **onsemi** reserves the right to make changes at any time to any products or information herein, without notice. The information herein is provided "as-is" and **onsemi** makes no warranty, representation or guarantee regarding the accuracy of the information, product features, availability, functionality, or suitability of its products for any particular purpose, nor does **onsemi** assume any liability arising out of the application or use of any product or circuit, and specifically disclaims any and all liability, including without limitation special, consequential or incidental damages. Buyer is responsible for its products and applications using **onsemi** products, including compliance with all laws, regulations and safety requirements or standards, regardless of any support or applications information provided by **onsemi**. "Typical" parameters which may be provided in **onsemi** data sheets and/or specifications can and do vary in different applications and actual performance may vary over time. All operating parameters, including "Typicals" must be validated for each customer application by customer's technical experts. **onsemi** does not convey any license under any of its intellectual property rights nor the rights of others. **onsemi** products are not designed, intended, or authorized for use as a critical component in life support systems or any FDA Class 3 medical devices or medical devices with a same or similar classification in a foreign jurisdiction or any devices intended for implantation in the human body. Should Buyer purchase or use **onsemi** products for any such unintended or unauthorized application, Buyer shall indemnify and hold **onsemi** and its officers, employees, subsidiaries, affiliates, and distributors harmless against all claims, costs, damages, and expenses, and reasonable attorney fees arising out of, directly or indirectly, any claim of personal injury or death associated with such unintended or unauthorized use, even if such claim alleges that **onsemi** was negligent regarding the design or manufacture of the part. **onsemi** is an Equal Opportunity/Affirmative Action Employer. This literature is subject to all applicable copyright laws and is not for resale in any manner.

PUBLICATION ORDERING INFORMATION

LITERATURE FULFILLMENT:

Email Requests to: orderlit@onsemi.com

onsemi Website: www.onsemi.com

TECHNICAL SUPPORT

North American Technical Support:

Voice Mail: 1 800-282-9855 Toll Free USA/Canada

Phone: 011 421 33 790 2910

Europe, Middle East and Africa Technical Support:

Phone: 00421 33 790 2910

For additional information, please contact your local Sales Representative