

C3216NP02J682J115AA

TDK Item Description : C3216NP02J682JT****



Application & Main Feature

Commercial Grade (High Temperature Application)

Series

C3216 [EIA 1206]

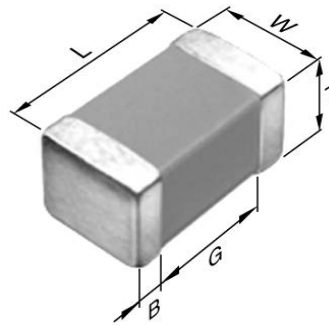

Dimensions

L	3.20mm ±0.20mm
W	1.60mm ±0.20mm
T	1.15mm ±0.15mm
B	0.20mm Min.
G	1.00mm Min.

Temperature Characteristic

NP0 (-55 to 150 degC 0+/-30ppm/degC)

Rated Voltage

2J(630Vdc)

Capacitance

6.8nF

Capacitance Tolerance

J (±5%)

Q Factor

1000 Min.

Insulation Resistance

10Gohm Min

AEC-Q200

Not Applicable

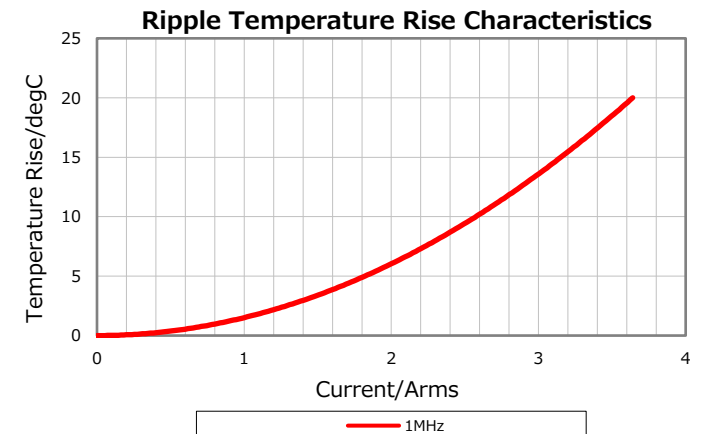
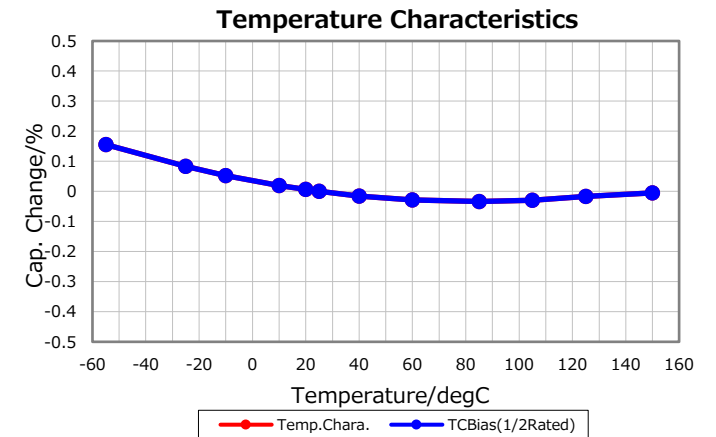
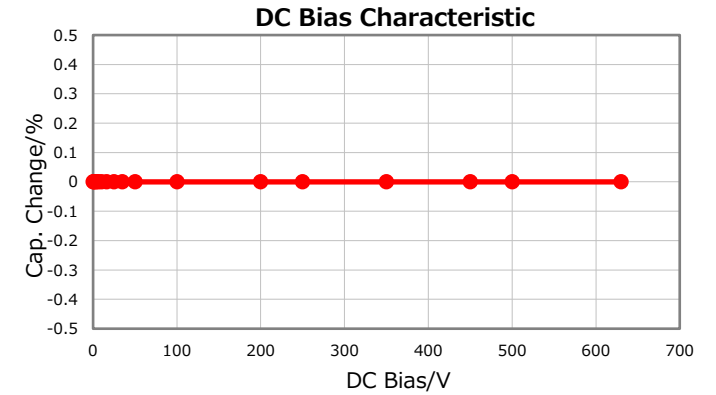
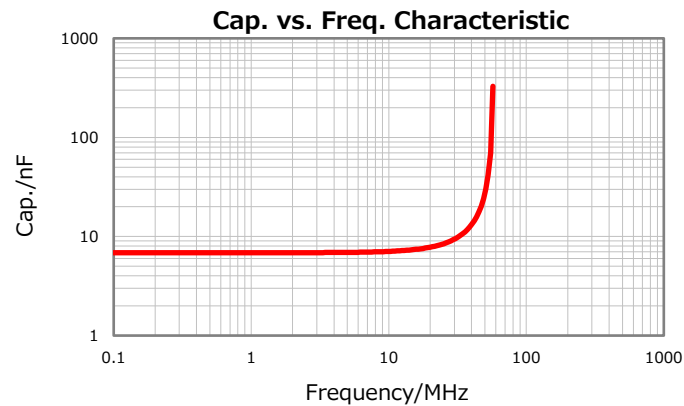
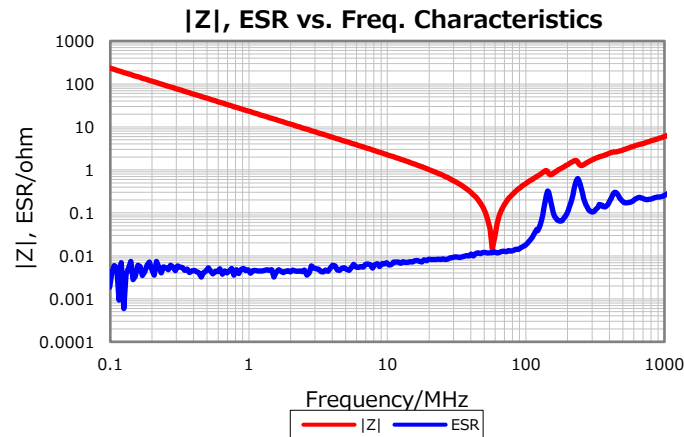

Characterization Sheet (Multilayer Ceramic Chip Capacitors)



All specifications are subject to change without notice.

July 2, 2019