



EMH2314

Power MOSFET -12V, 37mΩ, -5A, Dual P-Channel

ON Semiconductor®

<http://onsemi.com>

Features

- ON-resistance $R_{DS(on)} = 28\text{m}\Omega$ (typ.)
- 1.8V drive
- Halogen free compliance
- Protection Diode in

Specifications

Absolute Maximum Ratings at $T_a = 25^\circ\text{C}$

Parameter	Symbol	Conditions	Value	Unit
Drain-to-Source Voltage	V_{DSS}		-12	V
Gate-to-Source Voltage	V_{GSS}		± 8	V
Drain Current (DC)	I_D		-5	A
Drain Current (Pulse)	I_{DP}	$PW \leq 10\mu\text{s}$, duty cycle $\leq 1\%$	-20	A
Power Dissipation	P_D	When mounted on ceramic substrate (900mm ² × 0.8mm) 1unit	1.0	W
Total Dissipation	P_T	When mounted on ceramic substrate (900mm ² × 0.8mm)	1.2	W
Junction Temperature	T_j		150	°C
Storage Temperature	T_{stg}		-55 to +150	°C

Stresses exceeding those listed in the Maximum Ratings table may damage the device. If any of these limits are exceeded, device functionality should not be assumed, damage may occur and reliability may be affected.

Thermal Resistance Ratings

Parameter	Symbol	Value	Unit
Junction to Ambient When mounted on ceramic substrate (900mm ² × 0.8mm) 1unit	$R_{\theta JA}$	125	°C/W

Package Dimensions

unit : mm (typ)

7045-002

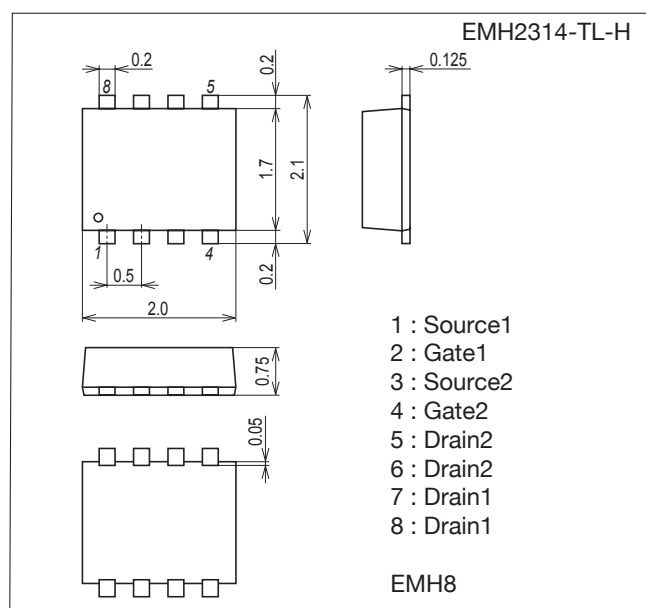

Product & Package Information

- Package : EMH8
- JEITA, JEDEC : -
- Minimum Packing Quantity : 3,000 pcs./reel

Taping Type : TL

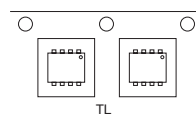

Marking

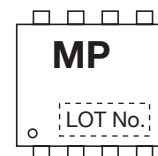

Electrical Connection

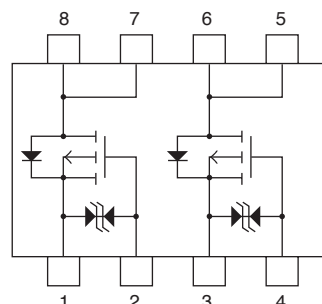

ORDERING INFORMATION

See detailed ordering and shipping information on page 2 of this data sheet.

EMH2314

Electrical Characteristics at Ta=25°C

Parameter	Symbol	Conditions	Ratings			Unit
			min	typ	max	
Drain-to-Source Breakdown Voltage	$V_{(BR)DSS}$	$I_D = -1mA, V_{GS} = 0V$	-12			V
Zero-Gate Voltage Drain Current	I_{DSS}	$V_{DS} = -12V, V_{GS} = 0V$			-10	μA
Gate-to-Source Leakage Current	I_{GSS}	$V_{GS} = \pm 8V, V_{DS} = 0V$			± 10	μA
Gate Threshold Voltage	$V_{GS(th)}$	$V_{DS} = -6V, I_D = -1mA$	-0.4		-1.3	V
Forward Transconductance	g_{FS}	$V_{DS} = -6V, I_D = -2.5A$		11		S
Static Drain-to-Source On-State Resistance	$R_{DS(on)1}$	$I_D = -2.5A, V_{GS} = -4.5V$		28	37	$m\Omega$
	$R_{DS(on)2}$	$I_D = -1.5A, V_{GS} = -2.5V$		53	75	$m\Omega$
	$R_{DS(on)3}$	$I_D = -0.5A, V_{GS} = -1.8V$		133	200	$m\Omega$
Input Capacitance	C_{iss}			1300		pF
Output Capacitance	C_{oss}	$V_{DS} = -6V, f = 1MHz$		158		pF
Reverse Transfer Capacitance	C_{rss}			143		pF
Turn-ON Delay Time	$t_{d(on)}$	See specified Test Circuit.		16		ns
Rise Time	t_r			77		ns
Turn-OFF Delay Time	$t_{d(off)}$			79		ns
Fall Time	t_f			58		ns
Total Gate Charge	Q_g				12	
Gate-to-Source Charge	Q_{gs}	$V_{DS} = -6V, V_{GS} = -4.5V, I_D = -5A$		3		nC
Gate-to-Drain "Miller" Charge	Q_{gd}			2		nC
Forward Diode Voltage	V_{SD}	$I_S = -5A, V_{GS} = 0V$		-0.9	-1.2	V

Product parametric performance is indicated in the Electrical Characteristics for the listed test conditions, unless otherwise noted. Product performance may not be indicated by the Electrical Characteristics if operated under different conditions.

Switching Time Test Circuit

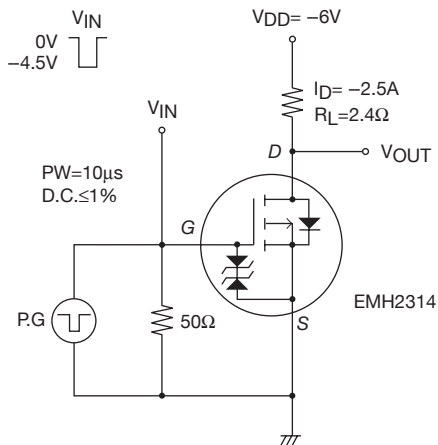

Ordering Information

Device	Package	Shipping	memo
EMH2314-TL-H	EMH8	3,000pcs./reel	Pb-Free and Halogen Free

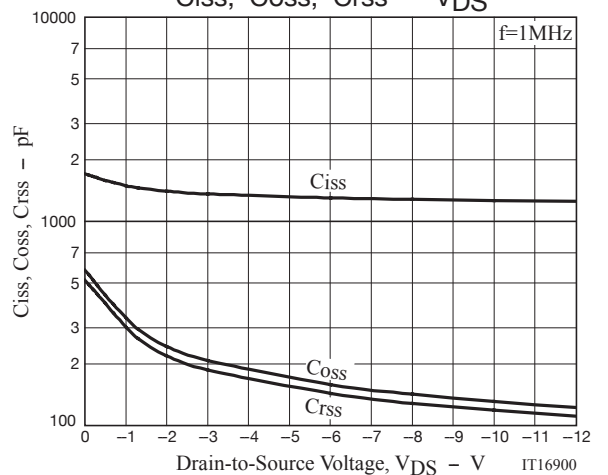
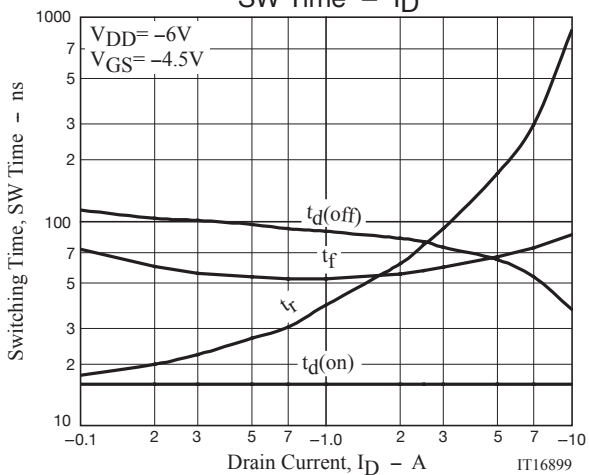
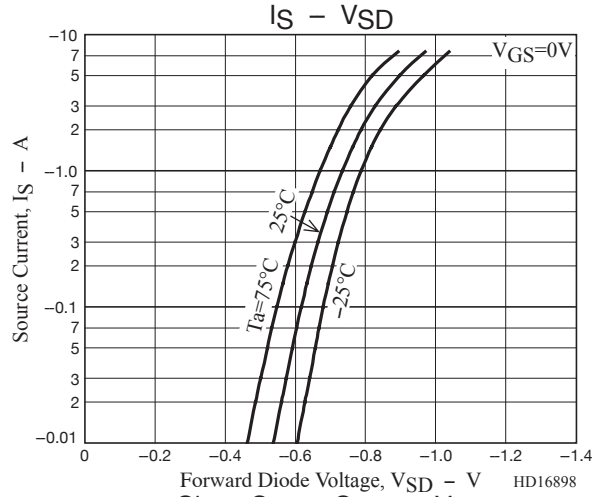
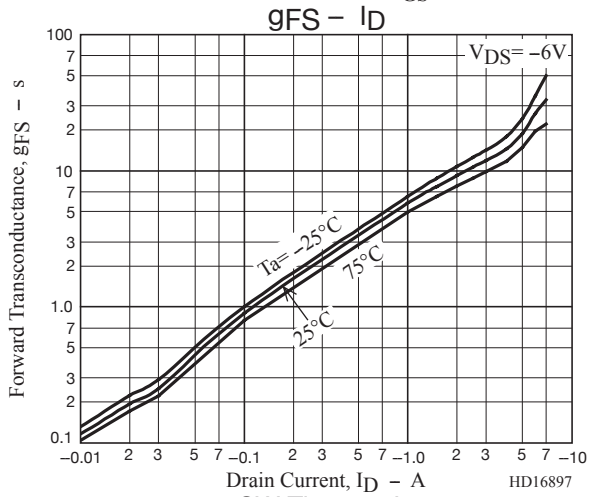
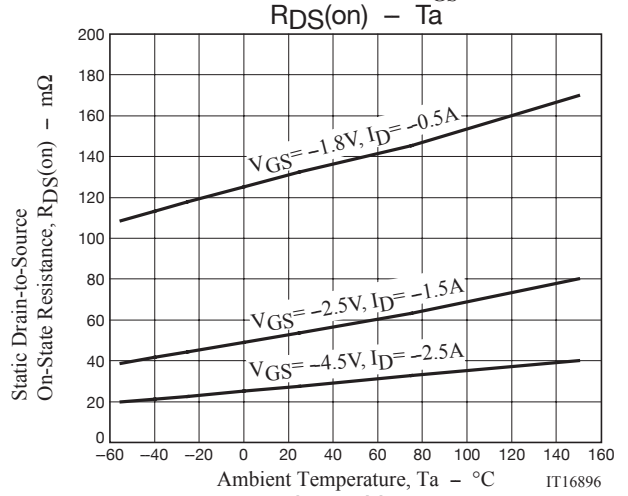
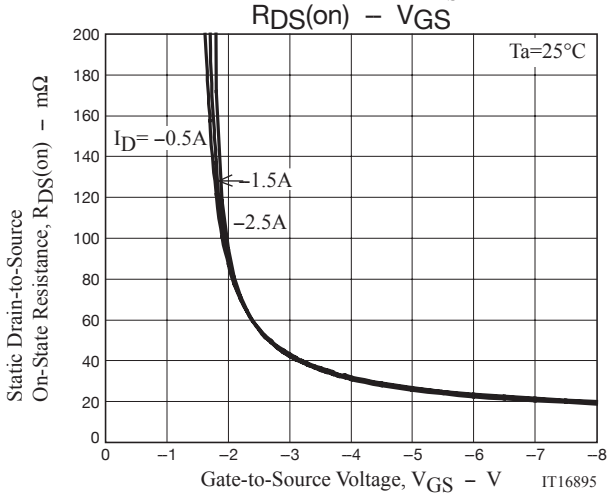
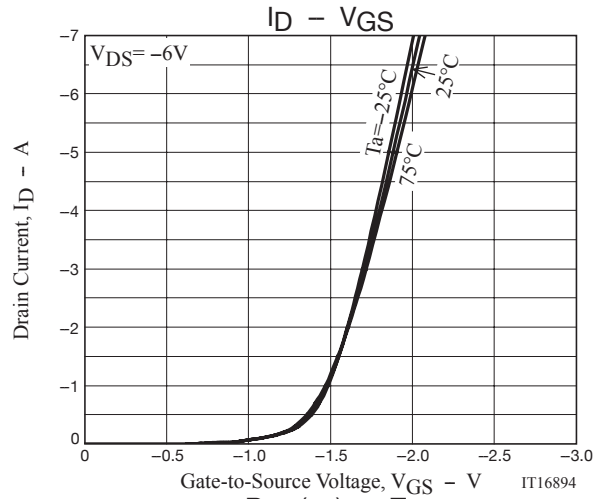
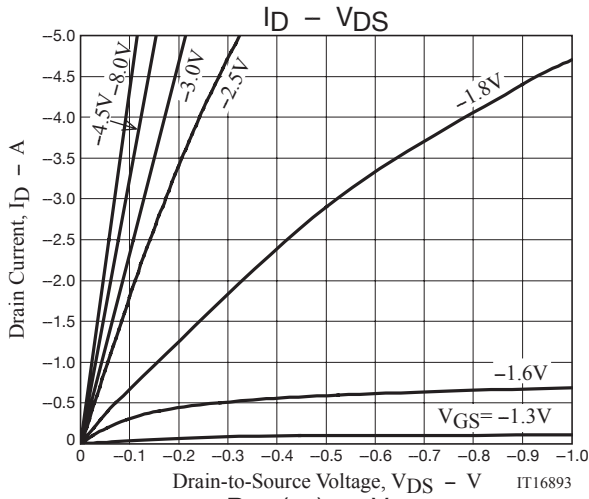

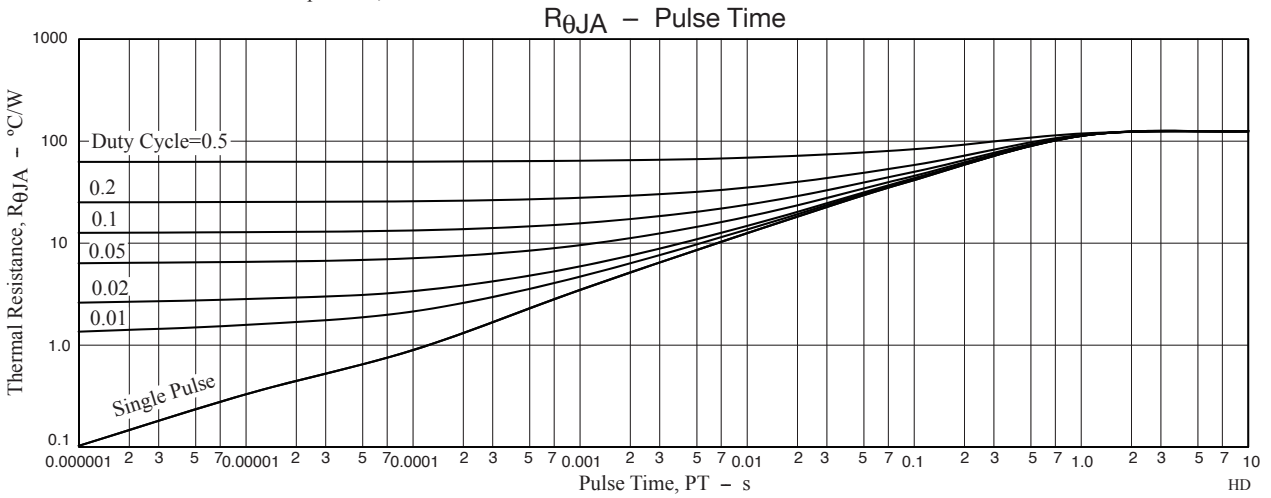
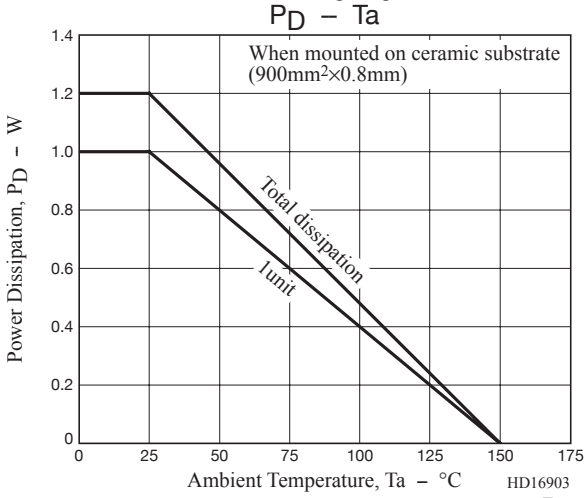
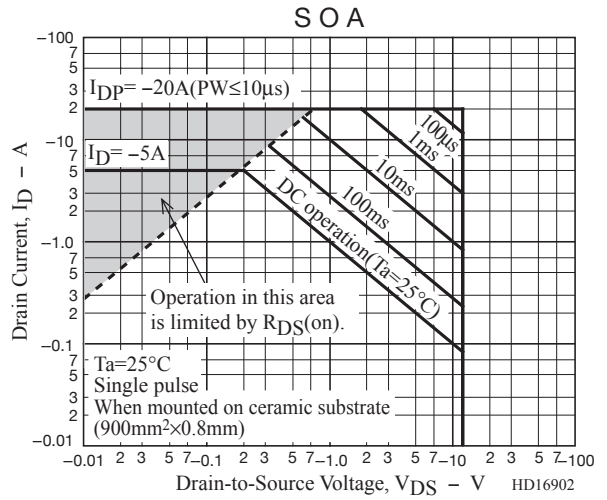
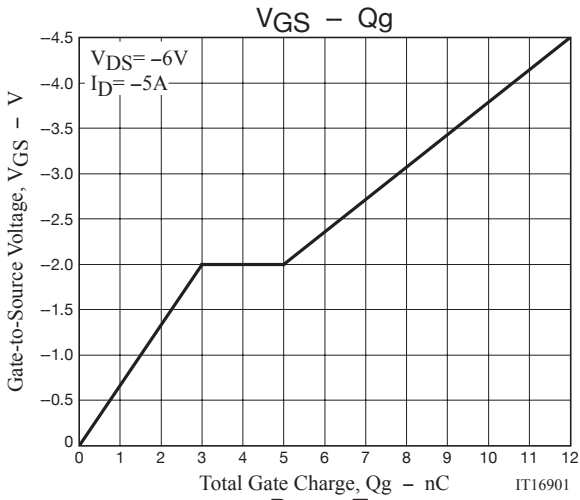

EMH2314

Outline Drawing

EMH2314-TL-H

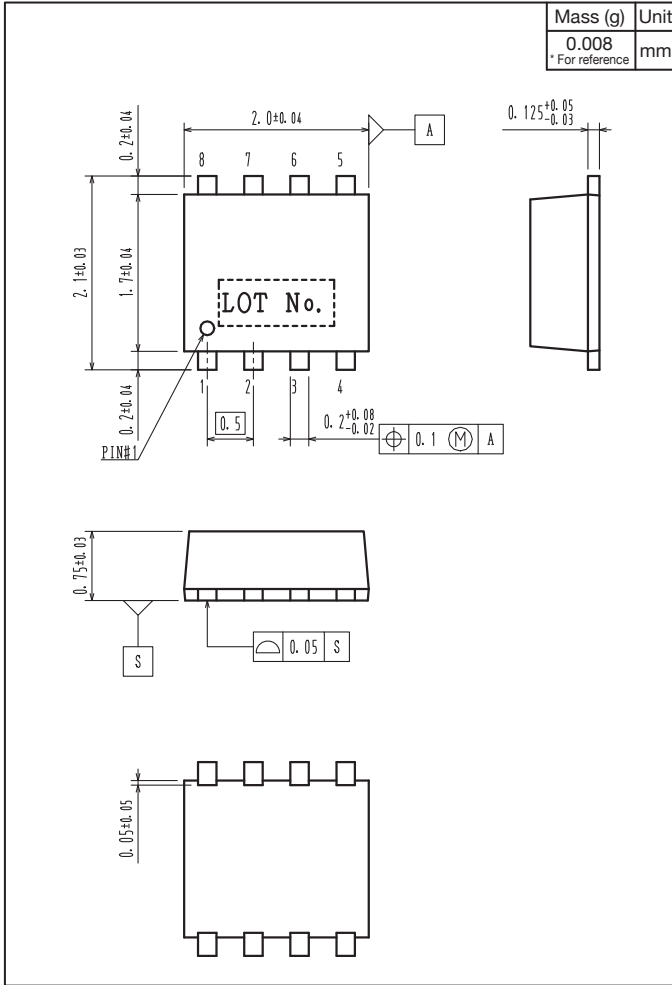

Land Pattern Example

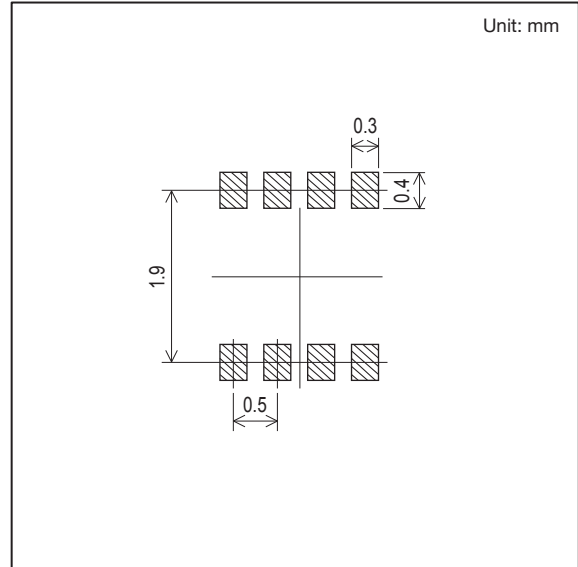

Note on usage : Since the EMH2314 is a MOSFET product, please avoid using this device in the vicinity of highly charged objects.

ON Semiconductor and the ON logo are registered trademarks of Semiconductor Components Industries, LLC (SCILLC) or its subsidiaries in the United States and/or other countries. SCILLC owns the rights to a number of patents, trademarks, copyrights, trade secrets, and other intellectual property. A listing of SCILLC's product/patent coverage may be accessed at www.onsemi.com/site/pdf/Patent-Marking.pdf. SCILLC reserves the right to make changes without further notice to any products herein. SCILLC makes no warranty, representation or guarantee regarding the suitability of its products for any particular purpose, nor does SCILLC assume any liability arising out of the application or use of any product or circuit, and specifically disclaims any and all liability, including without limitation special, consequential or incidental damages. "Typical" parameters which may be provided in SCILLC data sheets and/or specifications can and do vary in different applications and actual performance may vary over time. All operating parameters, including "Typicals" must be validated for each customer application by customer's technical experts. SCILLC does not convey any license under its patent rights nor the rights of others. SCILLC products are not designed, intended, or authorized for use as components in systems intended for surgical implant into the body, or other applications intended to support or sustain life, or for any other application in which the failure of the SCILLC product could create a situation where personal injury or death may occur. Should Buyer purchase or use SCILLC products for any such unintended or unauthorized application, Buyer shall indemnify and hold SCILLC and its officers, employees, subsidiaries, affiliates, and distributors harmless against all claims, costs, damages, and expenses, and reasonable attorney fees arising out of, directly or indirectly, any claim of personal injury or death associated with such unintended or unauthorized use, even if such claim alleges that SCILLC was negligent regarding the design or manufacture of the part. SCILLC is an Equal Opportunity/Affirmative Action Employer. This literature is subject to all applicable copyright laws and is not for resale in any manner.